

[54] **FLUORESCENT LIGHT FIXTURE**

[75] **Inventor:** Donald D. Szymanek, Westlake, Calif.  
[73] **Assignee:** REC Specialties, Camarillo, Calif.  
[\*\*] **Term:** 14 Years  
[21] **Appl. No.:** 842,862

[22] **Filed:** Mar. 12, 1986  
[52] **U.S. Cl. ....** D26/76  
[58] **Field of Search ....** D26/72, 80-92,  
D26/75-79; 362/404-408, 362, 363, 147, 217,  
222, 223, 33

[56] **References Cited**  
**U.S. PATENT DOCUMENTS**  
D. 206,286 11/1966 Ostyn ..... D26/76  
2,694,775 11/1954 Florence ..... D26/76 X

**OTHER PUBLICATIONS**

Legion Lighting Co. advance data sheet file 31-F2 1966, Fluorescent Lamp.  
Legion Lighting Co., "Prismalite" page, file 31-F23, Fluorescent Lamp.  
*Primary Examiner*—Susan J. Lucas  
*Attorney, Agent, or Firm*—Fulwider, Patton Rieber, Lee & Utecht

[57] **CLAIM**  
The ornamental design for a light fixture, as shown and described.

**DESCRIPTION**

FIG. 1 is a fragmentary front elevational view of a fluorescent light fixture showing my new design, the rear being a mirror image;  
FIG. 2 is a fragmentary bottom plan view thereof;  
FIG. 3 is a fragmentary top plan view thereof;  
FIG. 4 is a left end elevational view thereof;  
FIG. 5 is a right elevational view thereof;  
FIG. 6 is a fragmentary perspective view thereof, on an enlarged scale.  
The figures are broken away in FIGS. 1, 2, 3 and 6 for convenience of illustration.

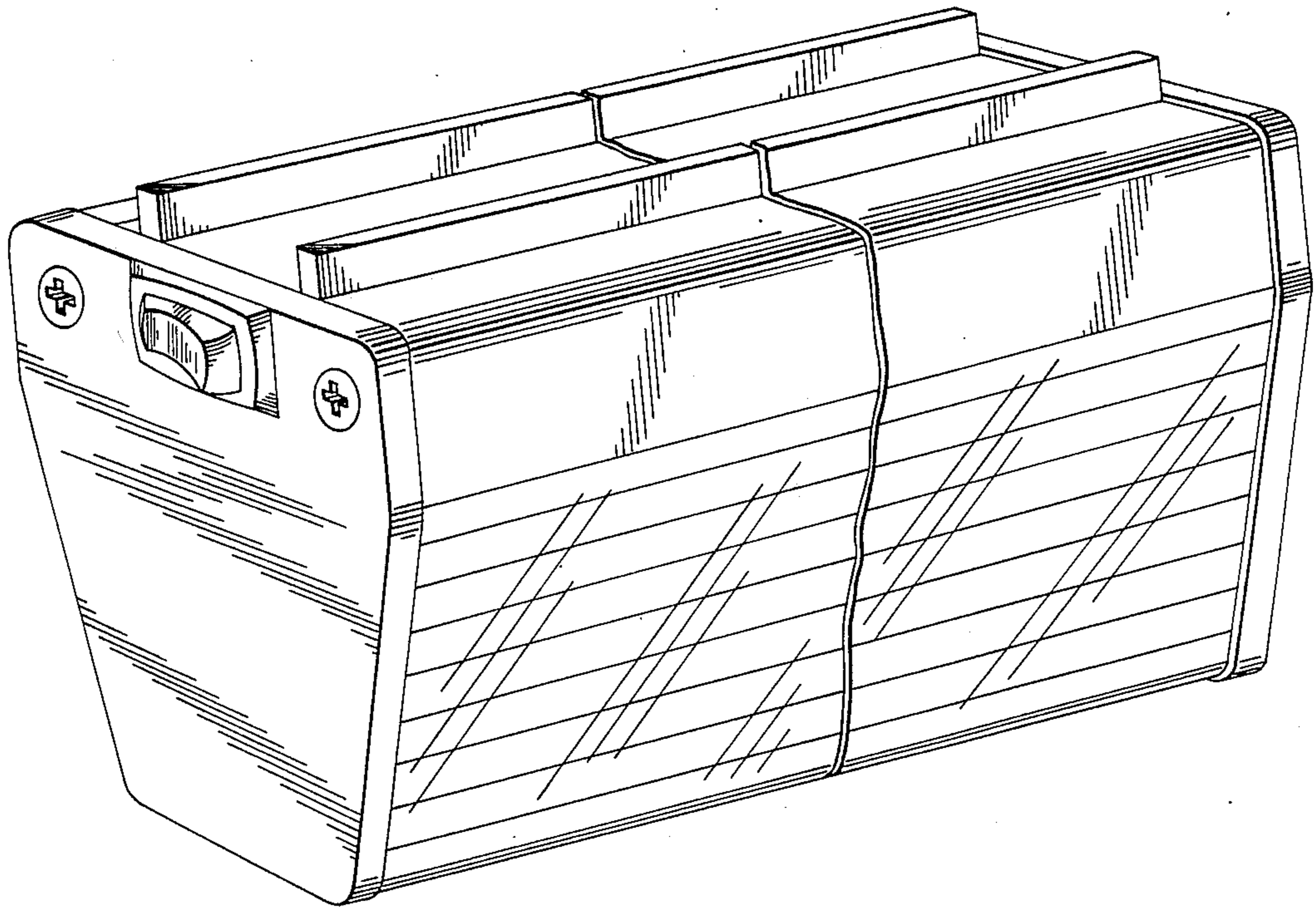

FIG. 1

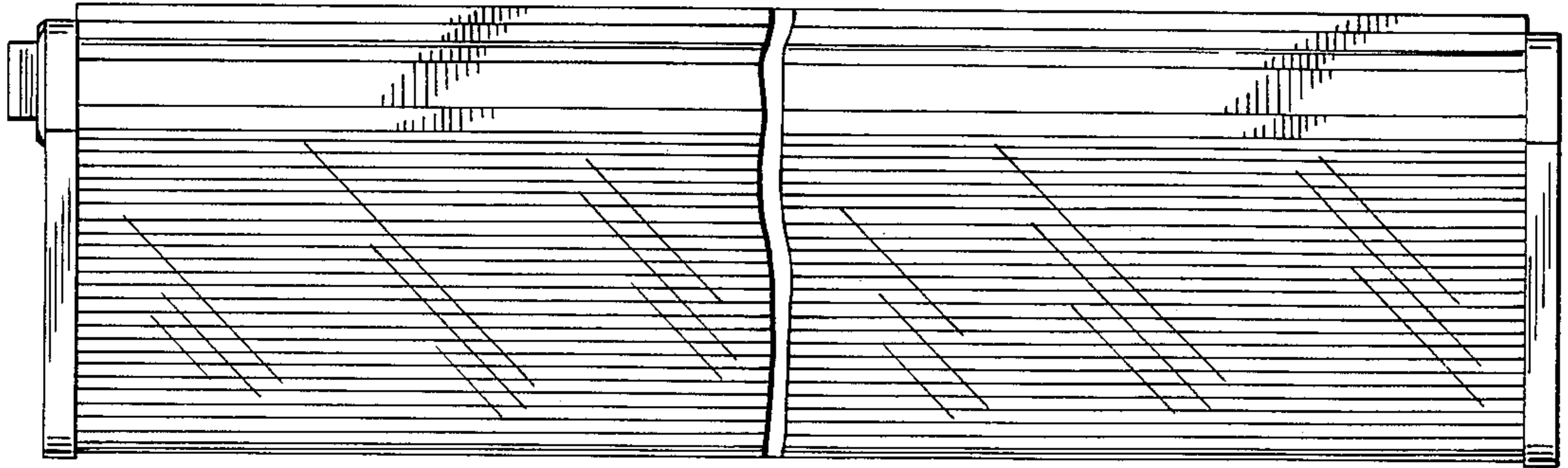

FIG. 2

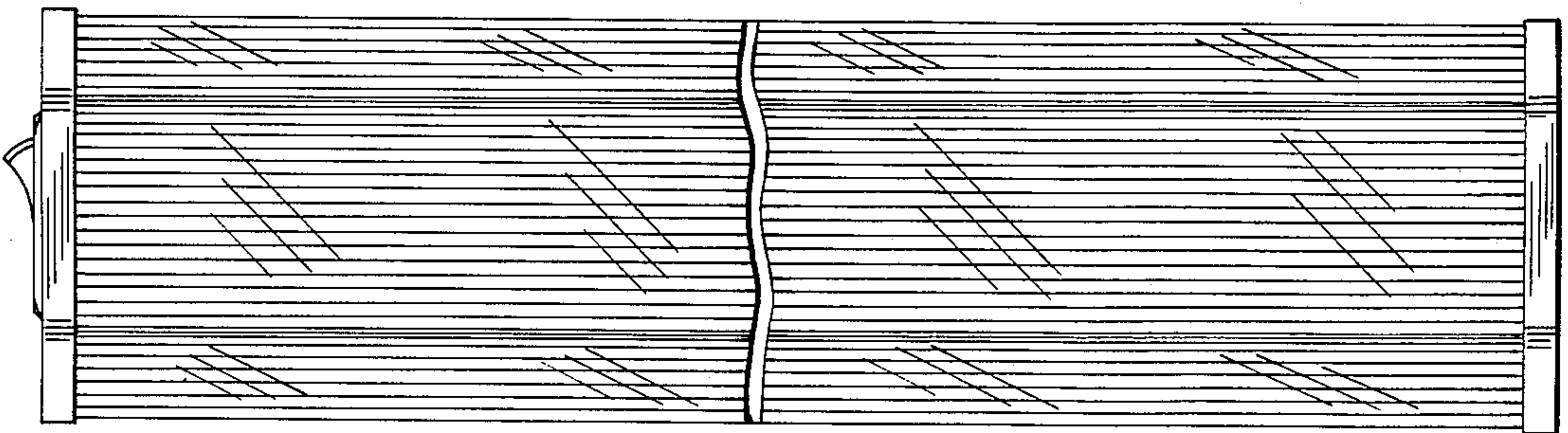

FIG. 3

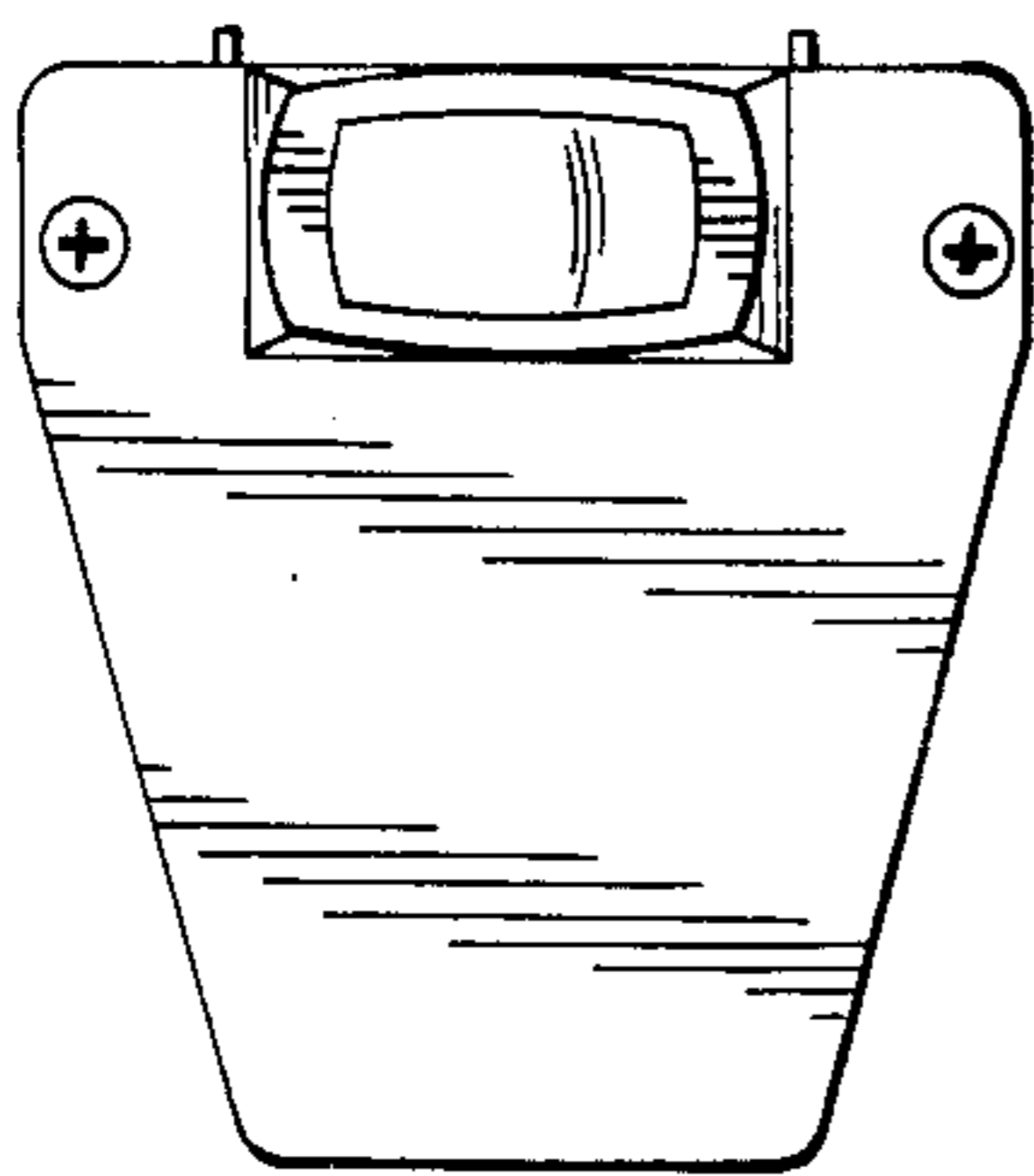
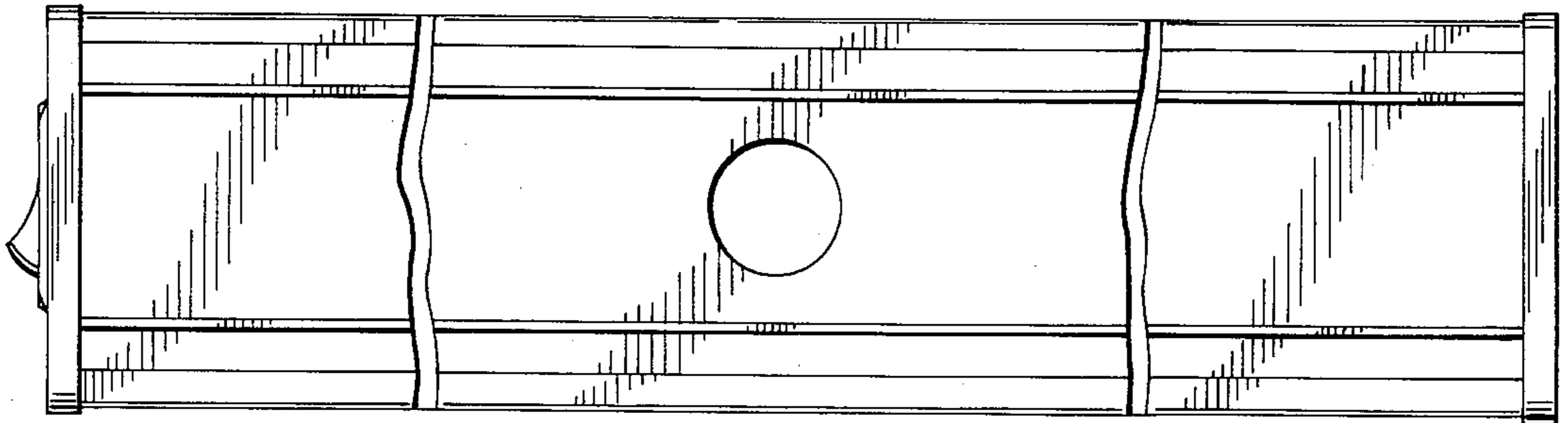

FIG. 4

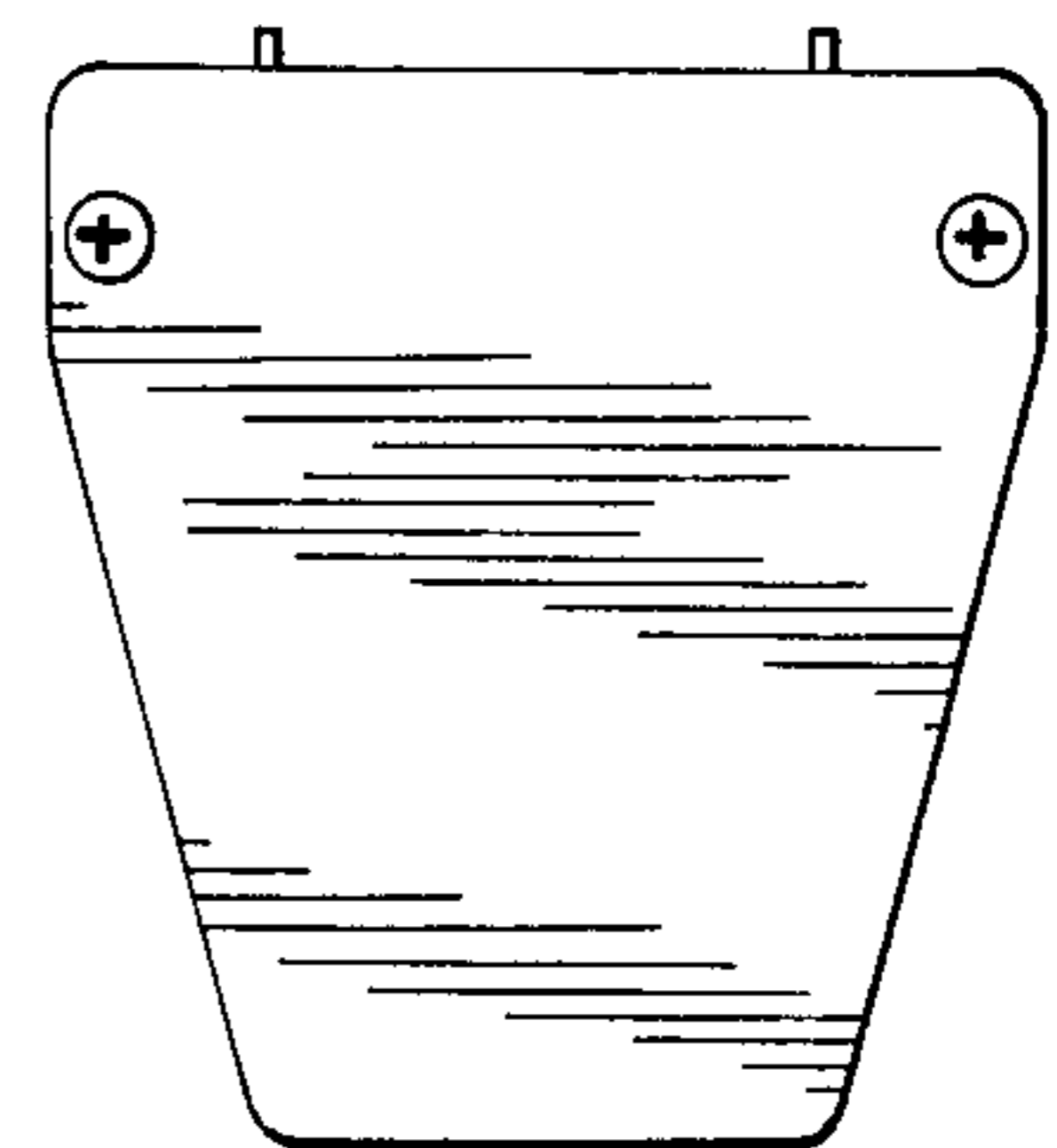

FIG. 5

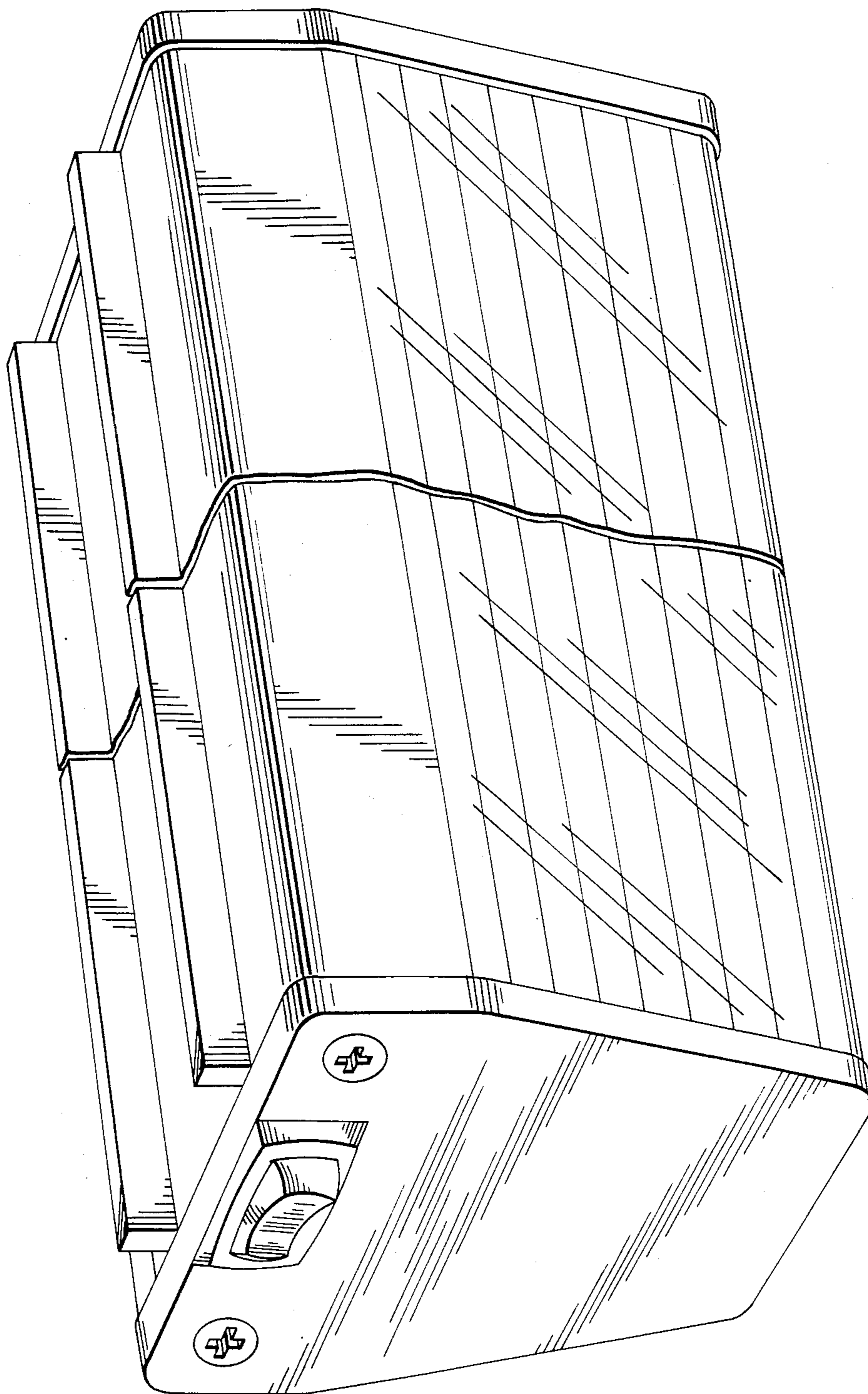

FIG. 6