

[54] COMBINED AIR COMPRESSOR AND FLASHLIGHT

[75] Inventors: Peter Byar, Willingboro, N.J.; Edward Spector, Philadelphia, Pa.

[73] Assignee: Interdynamics, Inc., Brooklyn, N.Y.

[**] Term: 14 Years

[21] Appl. No.: 85,002

[22] Filed: Aug. 12, 1987

[52] U.S. Cl. D15/9; D26/38

[58] Field of Search D15/7, 9; D26/38; 417/63, 231, 234, 236, 410-411, 415; 141/38; 362/109

[56] References Cited

U.S. PATENT DOCUMENTS

| | | | |
|------------|--------|-------------|----------|
| D. 270,733 | 9/1983 | Davis | D15/9 |
| D. 289,297 | 4/1987 | Liu | D15/7 |
| D. 293,682 | 1/1988 | Liou | D15/9 |
| D. 295,754 | 5/1988 | Wang | D15/9 |
| D. 296,104 | 6/1988 | Hung | D26/38 X |

OTHER PUBLICATIONS

Martec Deluxe Air Compressor brochure.

Primary Examiner—Wallace R. Burke

Assistant Examiner—Brian N. Vinson

Attorney, Agent, or Firm—Henry R. Lerner

[57] CLAIM

The ornamental design for a combined air compressor and flashlight, as shown.

DESCRIPTION

FIG. 1 is a front, top and right side perspective view of a combined air compressor and flashlight showing our new design;

FIG. 2 is a top plan view thereof;

FIG. 3 is a front elevational view thereof;

FIG. 4 is a right side view thereof;

FIG. 5 is a left side view thereof;

FIG. 6 is a rear elevational view thereof;

FIG. 7 is a bottom plan view thereof; and

FIG. 8 is an exploded perspective view thereof, with the flashlight portion shown rotated ninety degrees.

The broken-line showing of the numerals on the panel and the tubular element are for illustrative purposes only and form no part of the claimed design.

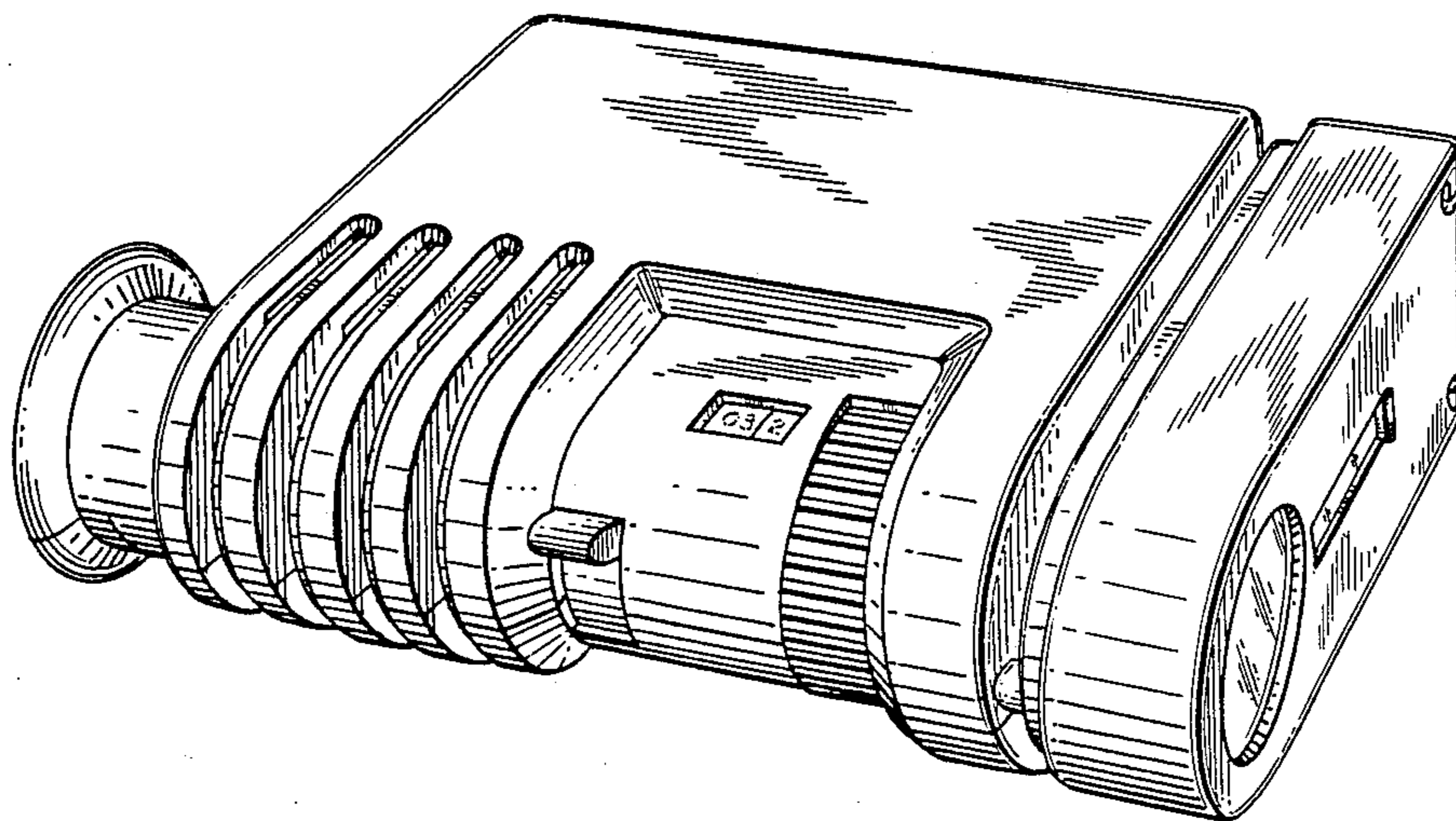

FIG. 1

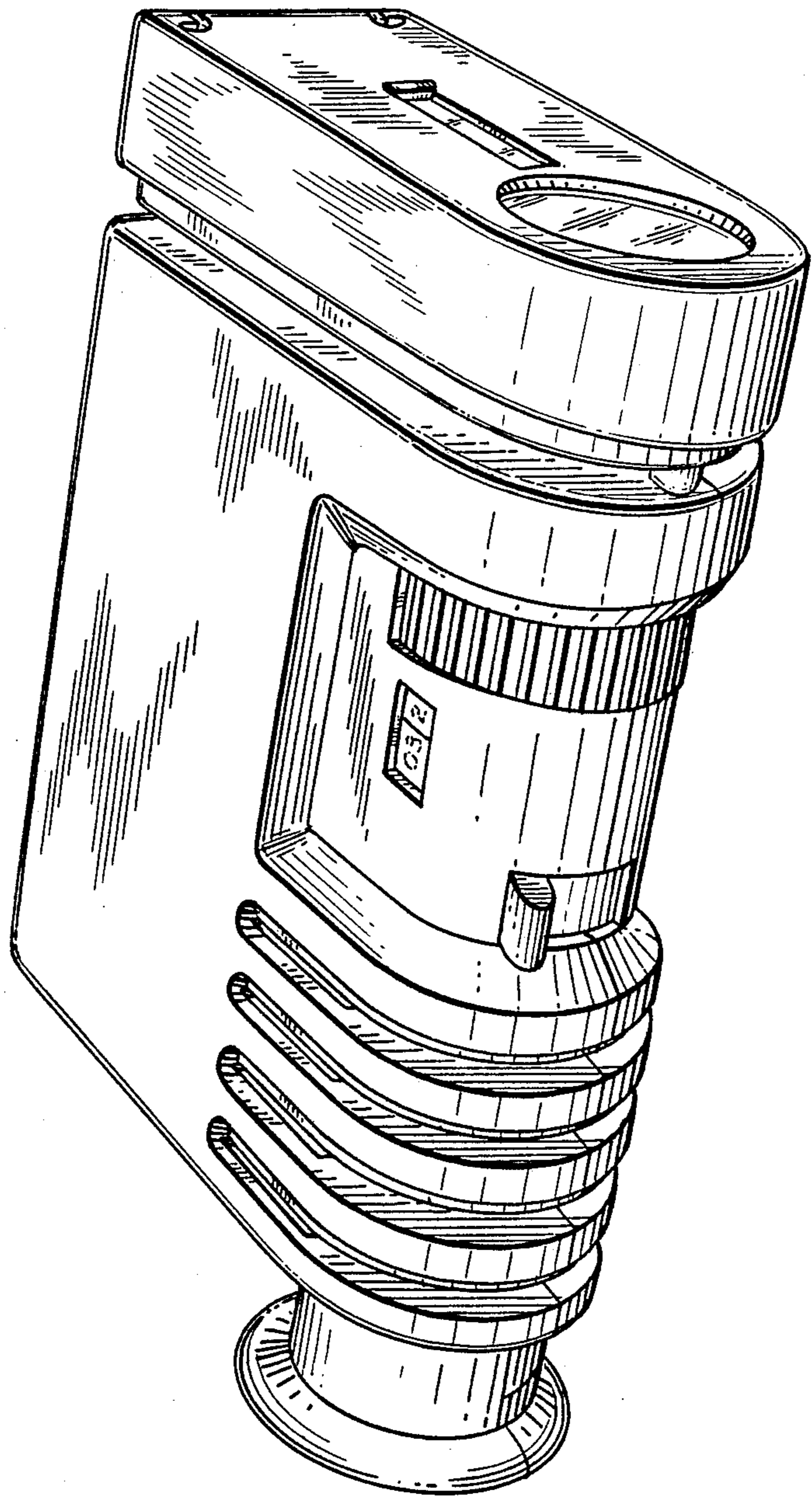

FIG. 2

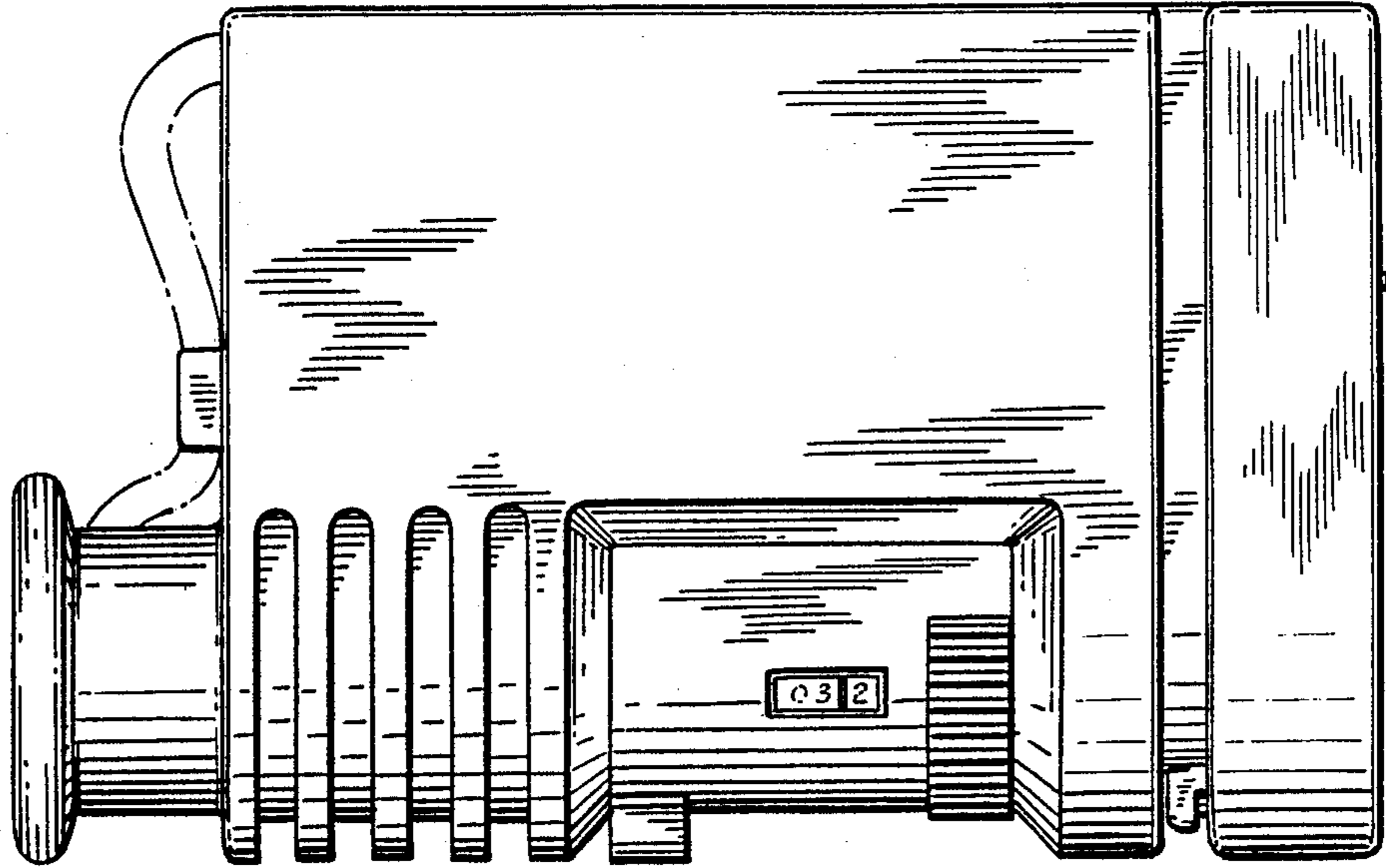

FIG. 3

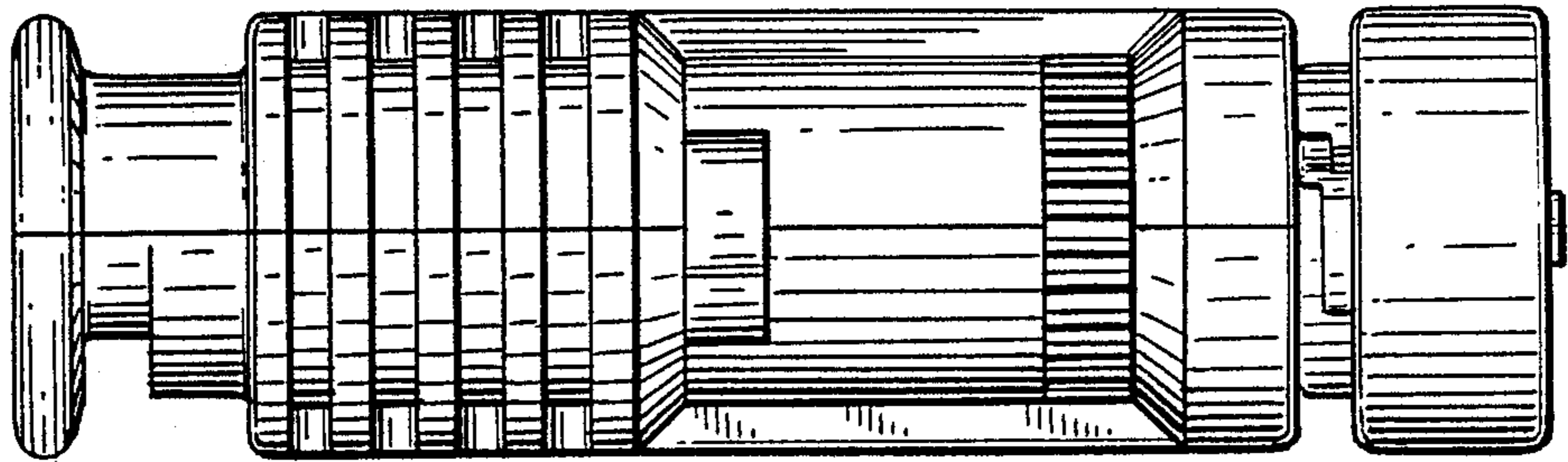

FIG. 4

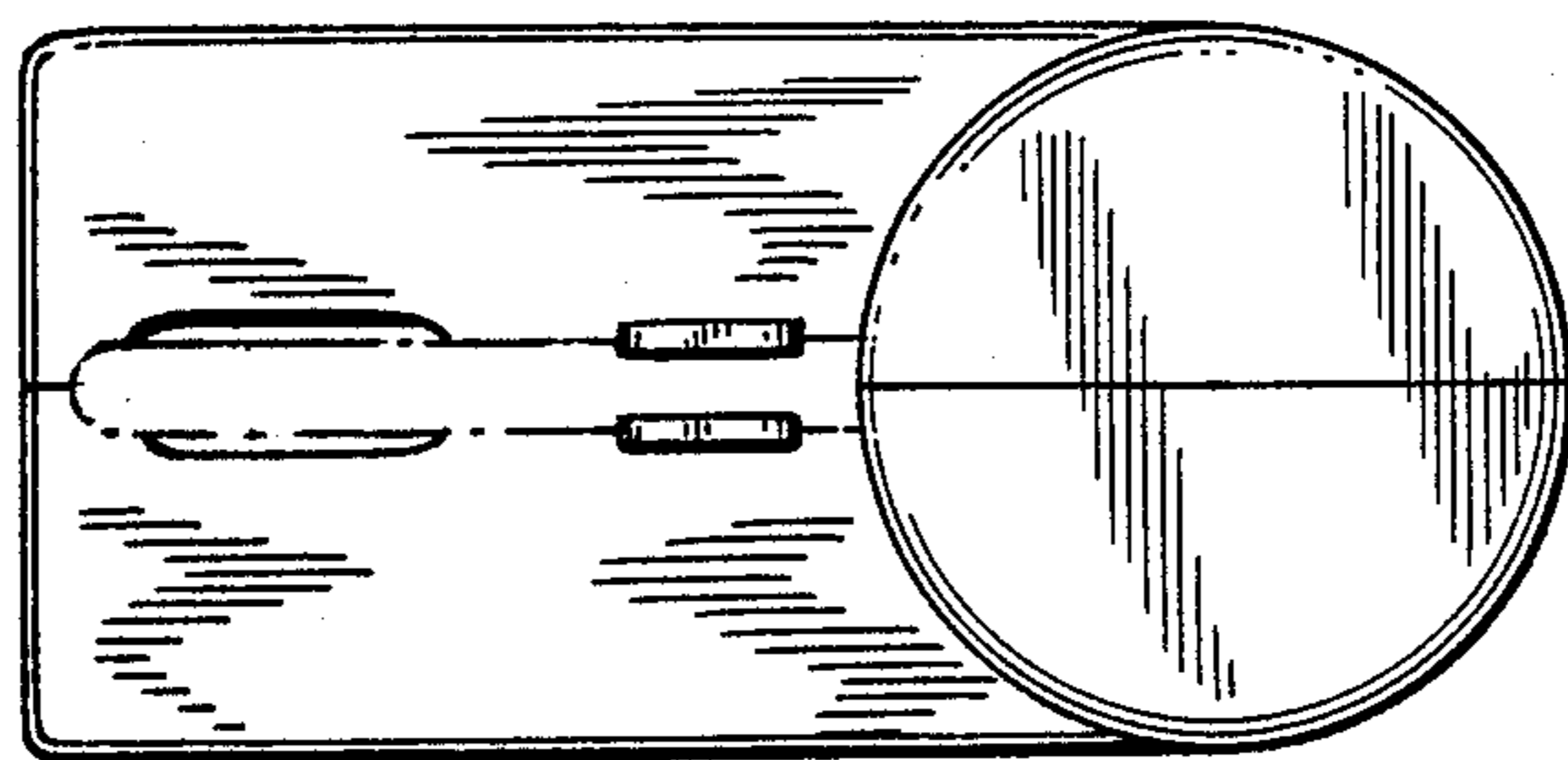
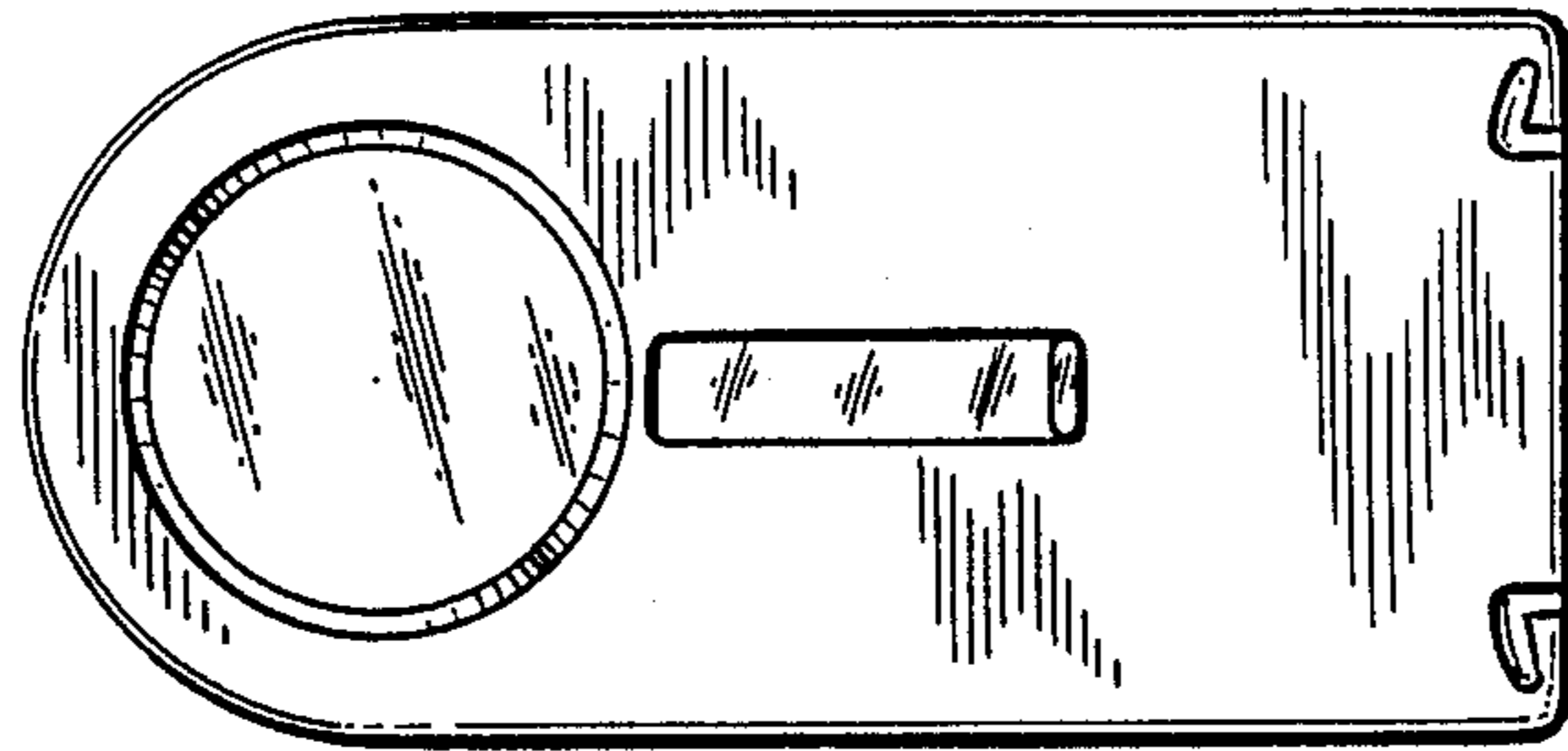

FIG. 5

FIG. 6

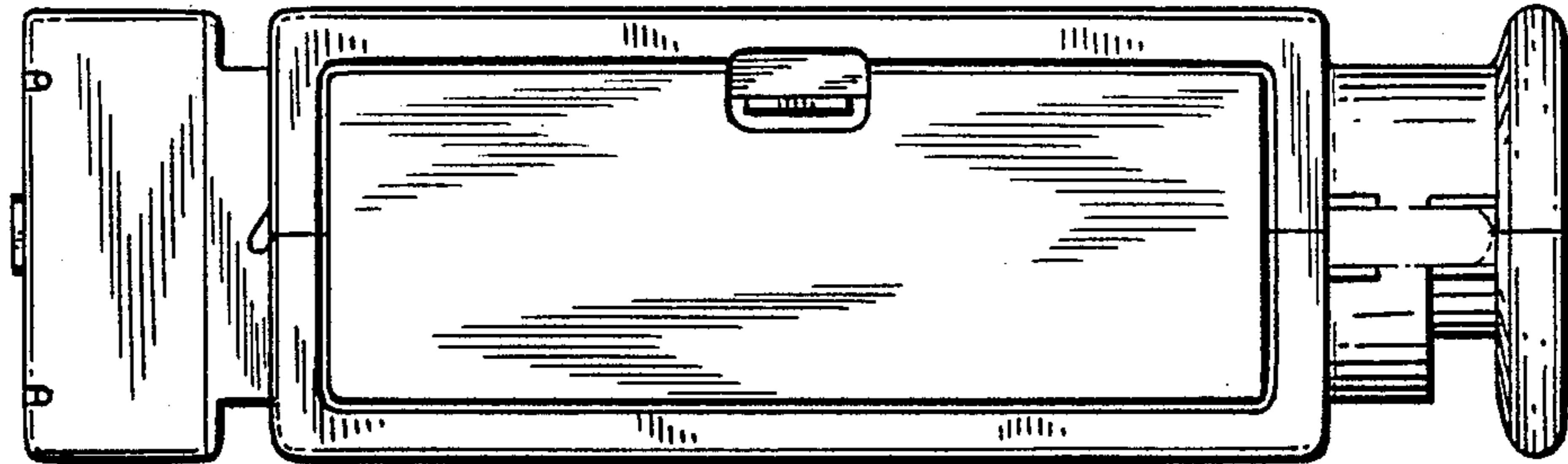

FIG. 7

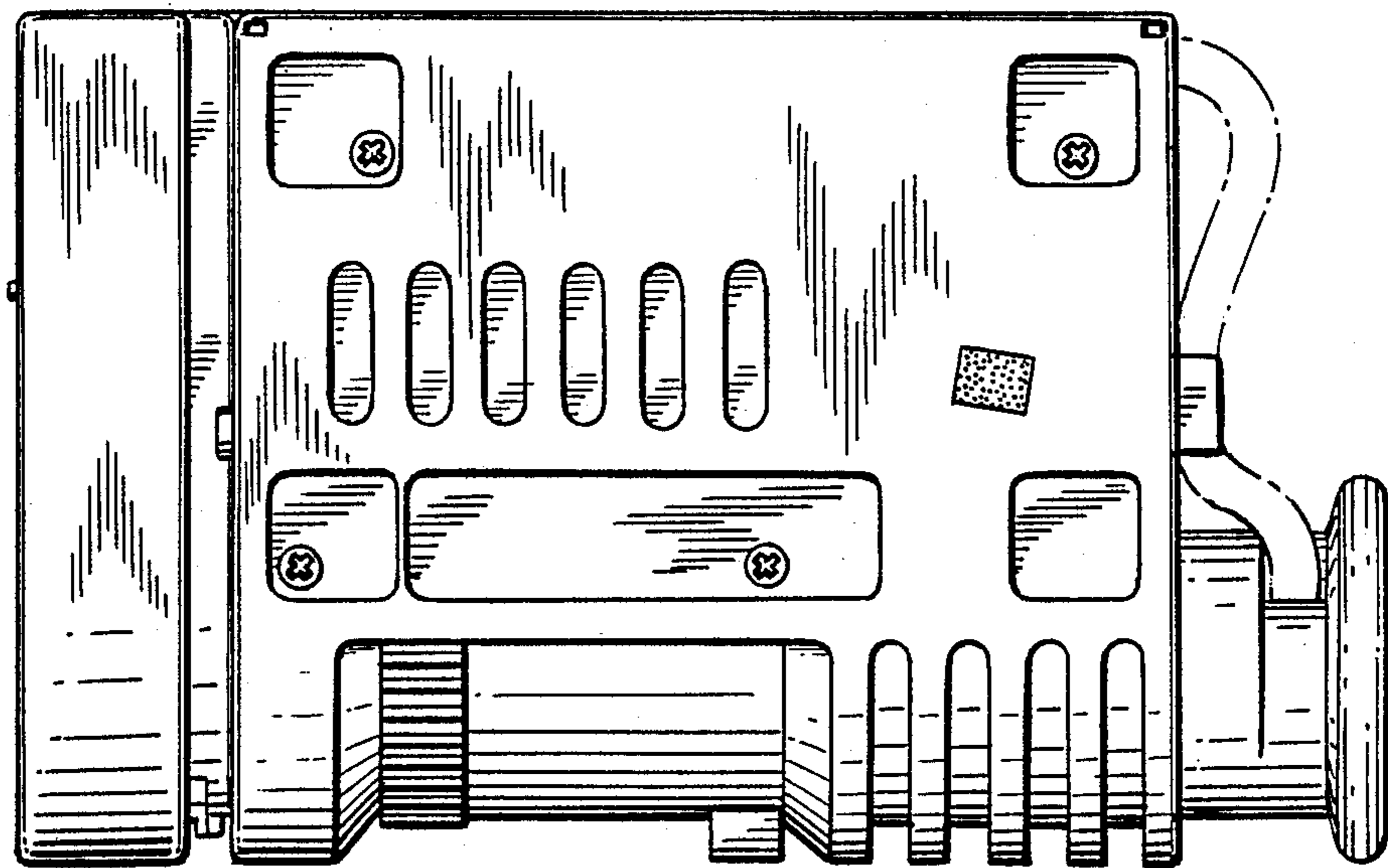

FIG. 8

