

[54] ADJUSTABLE LAMP

[75] Inventor: Haim Shwisha, Westport, Conn.

[73] Assignee: Electrix, Inc., New Haven, Conn.

[**] Term: 14 Years

[21] Appl. No.: 842,010

[22] Filed: Mar. 7, 1986

[52] U.S. Cl. D26/63

[58] Field of Search D26/60-66,
D26/93, 102-112; 362/269, 275, 287, 375, 362,
418, 427, 410-414

[56] References Cited

U.S. PATENT DOCUMENTS

D. 118,671	1/1940	Mielziner	D26/63
D. 206,952	2/1967	Fletcher	D26/63
D. 223,282	4/1972	Andre	D26/63
D. 295,449	4/1988	Shwisha	D26/93

OTHER PUBLICATIONS

Bruce Industries Lighting catalog, fall 1972-1973, p. 4, accent lamp, #200.

Primary Examiner—Susan J. Lucas
Attorney, Agent, or Firm—Bachman & LaPointe

[57] CLAIM

The ornamental design for an adjustable lamp, as shown and described.

DESCRIPTION

FIG. 1 is a front perspective view of an adjustable lamp showing my new design;
 FIG. 2 is a top plan view thereof;
 FIG. 3 is a front elevational view thereof;
 FIG. 4 is a side elevational view thereof, the opposite side being a mirror image;
 FIG. 5 is a rear elevational view thereof;
 FIG. 6 is a bottom plan view thereof;
 FIG. 7 is a front elevational view of a second embodiment of my new design;
 FIG. 8 is a side elevational view thereof, the opposite side being a mirror image;
 FIG. 9 is a rear elevational view thereof;
 FIG. 10 is a top plan view thereof; and
 FIG. 11 is a bottom plan view thereof.

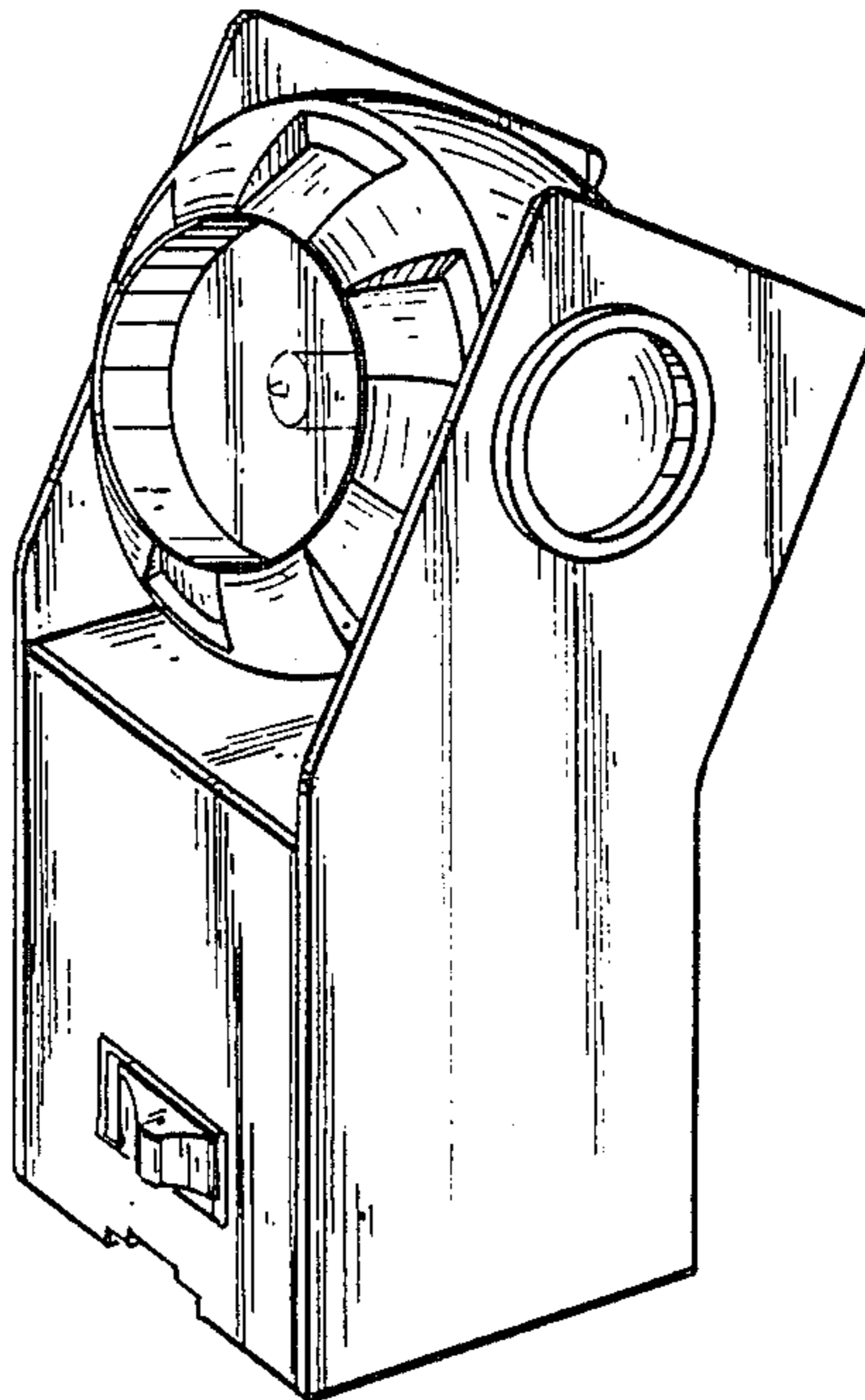

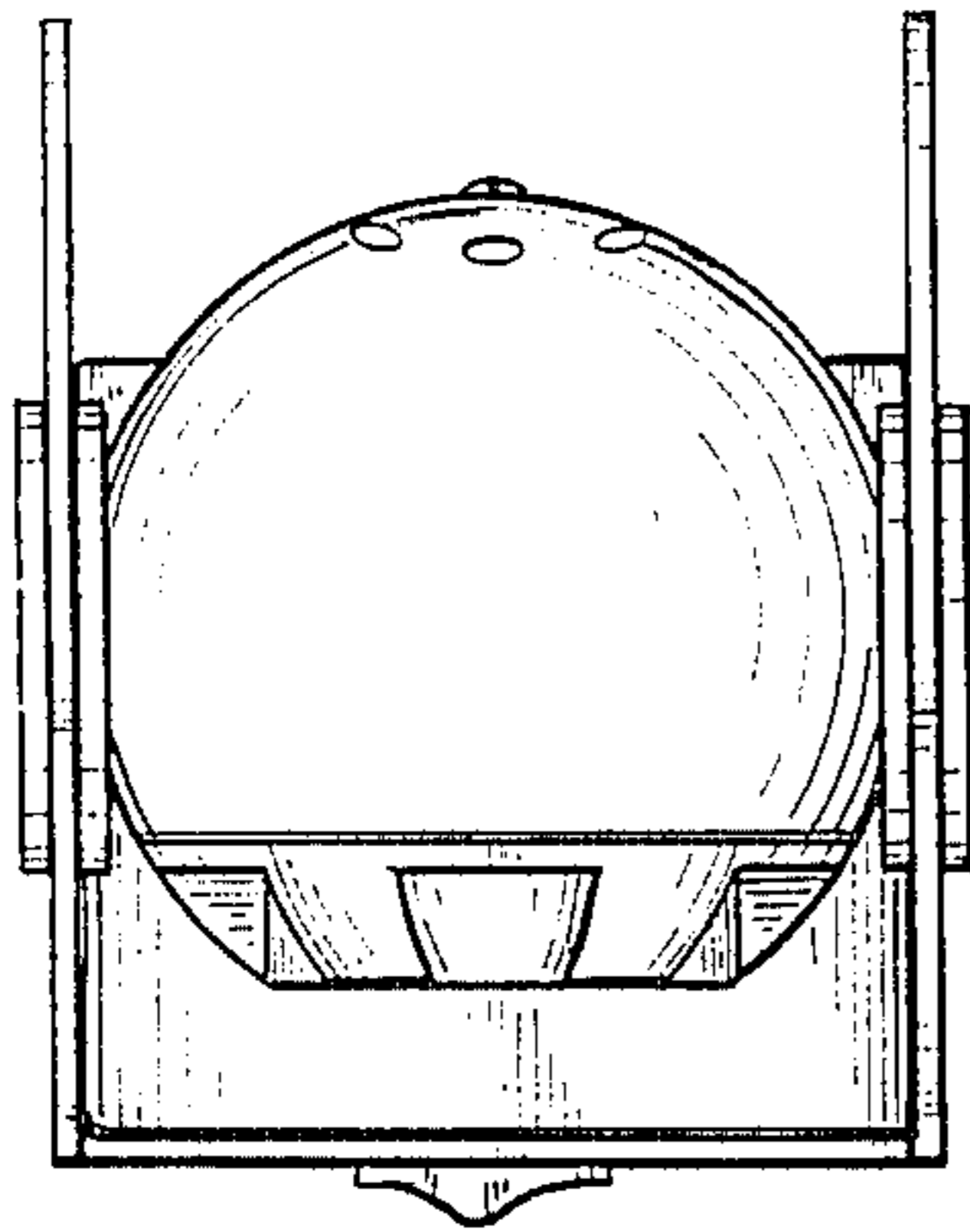

FIG-2

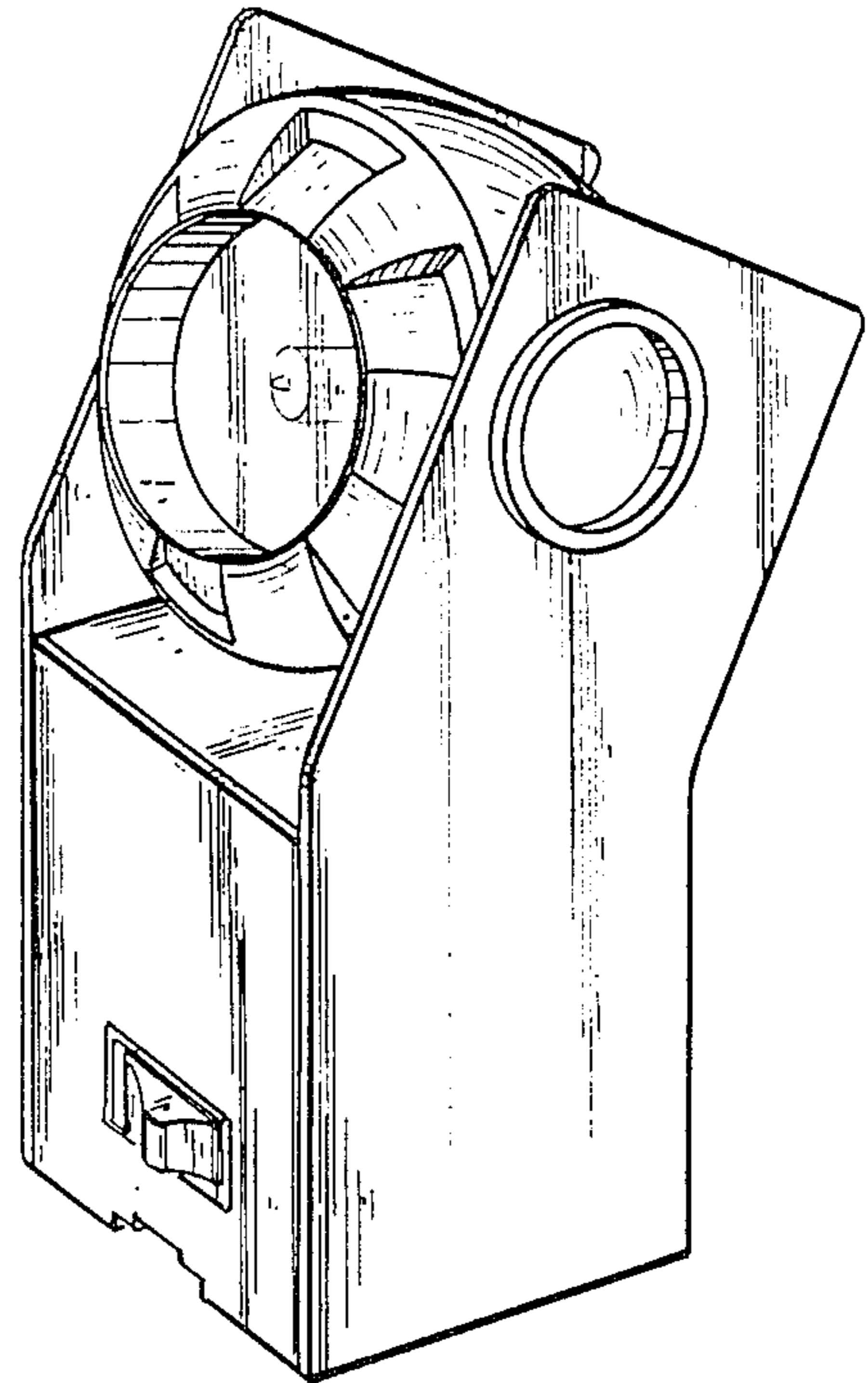

FIG-1

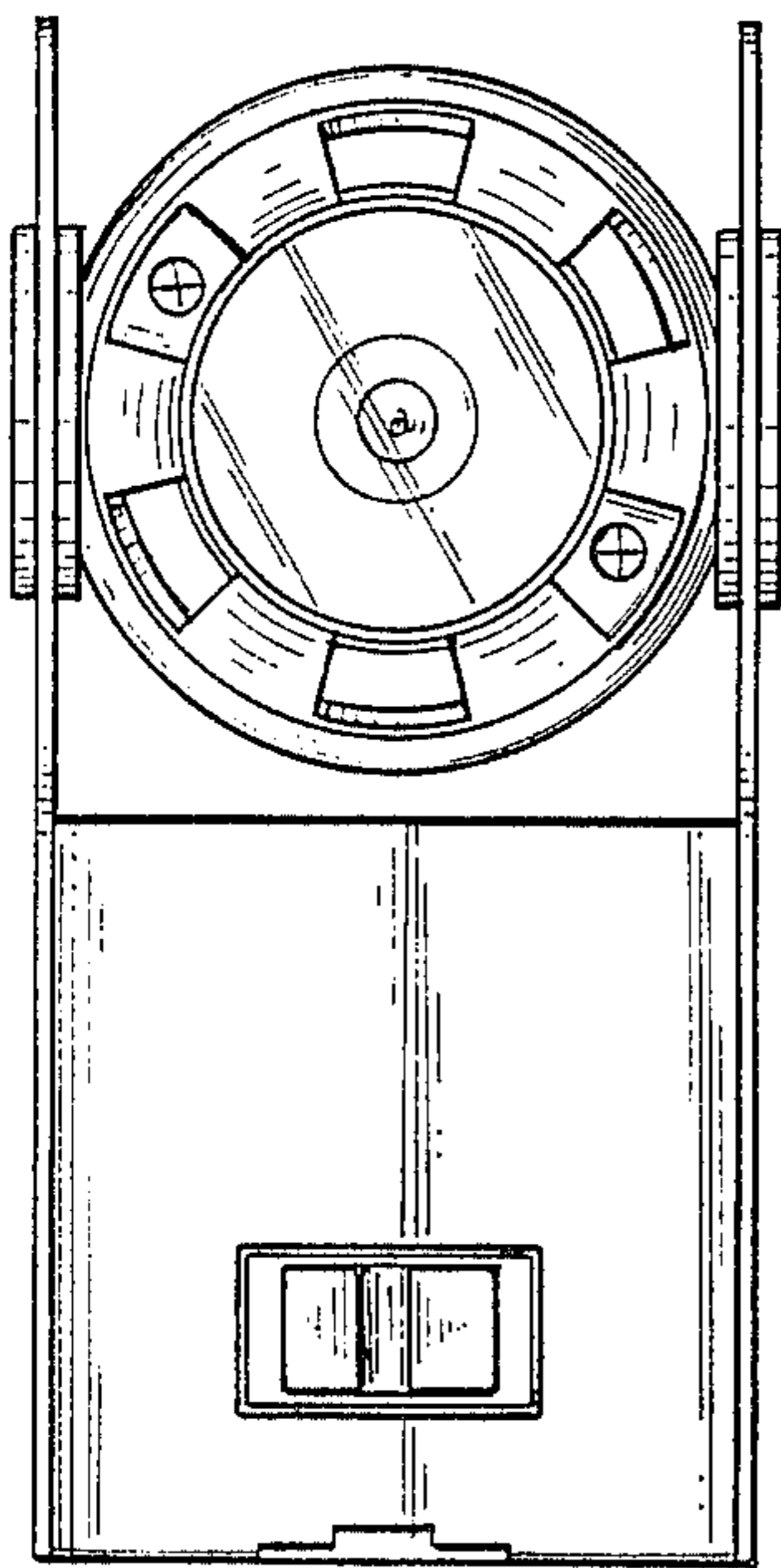

FIG-3

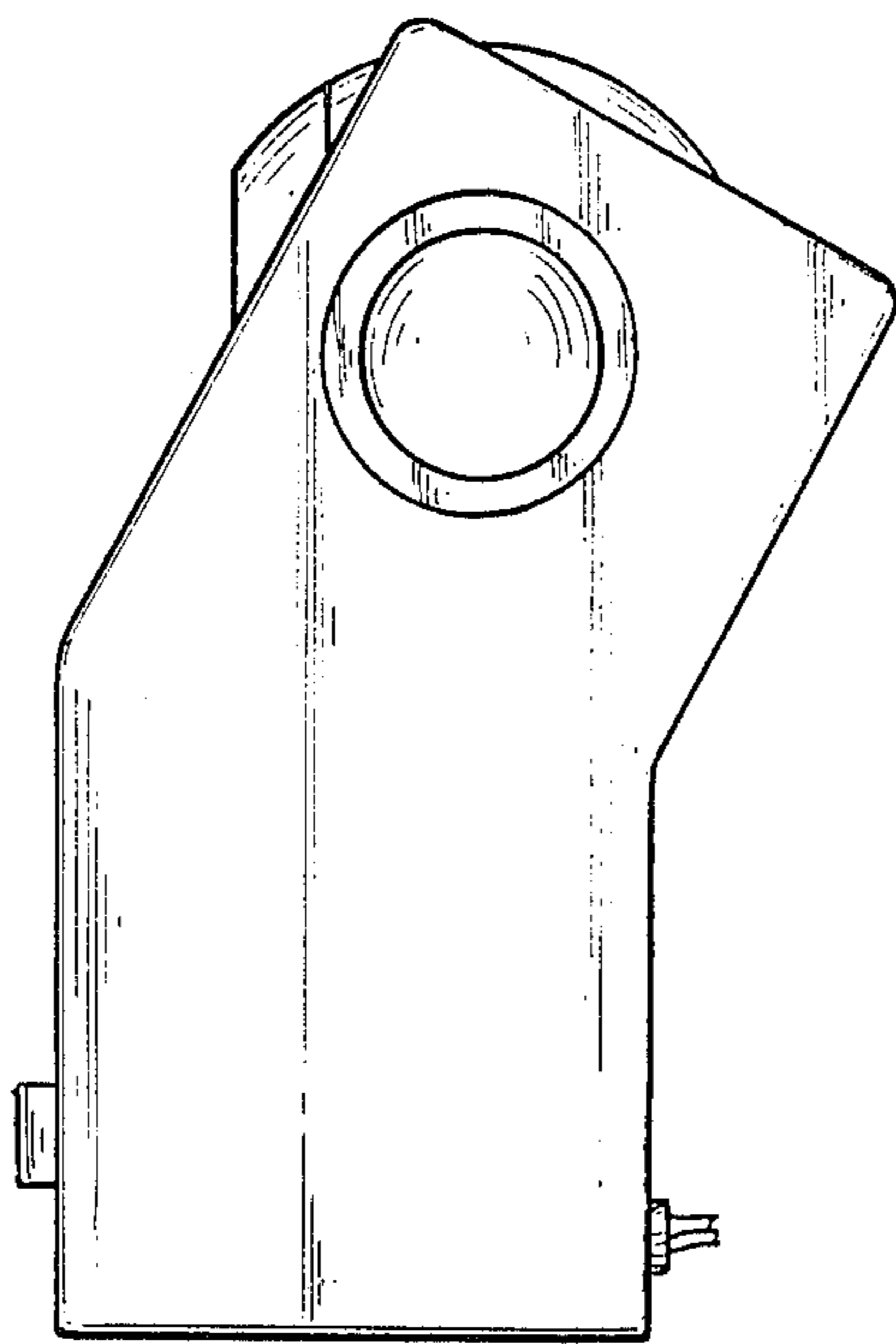

FIG-4

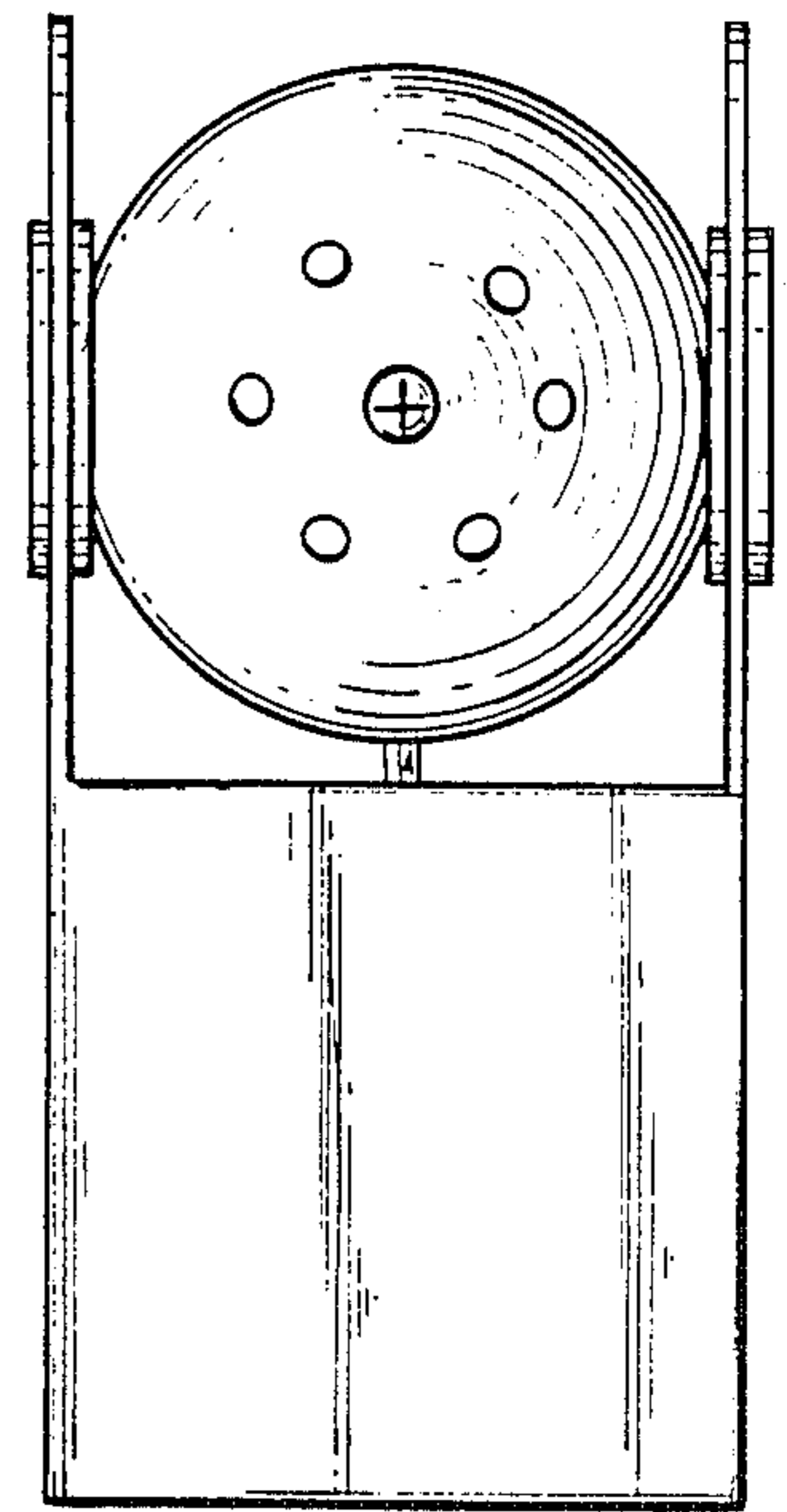

FIG-5

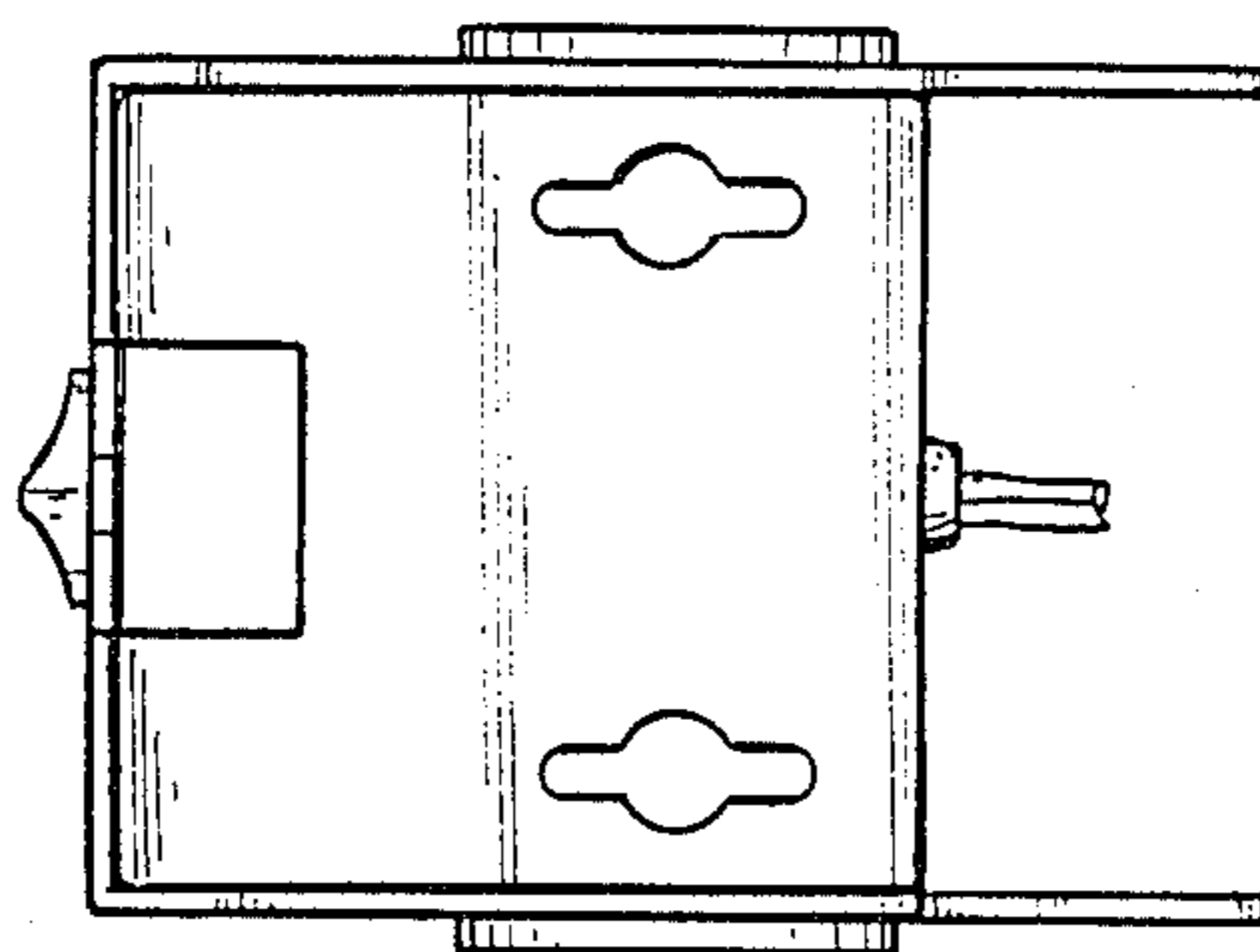

FIG-6

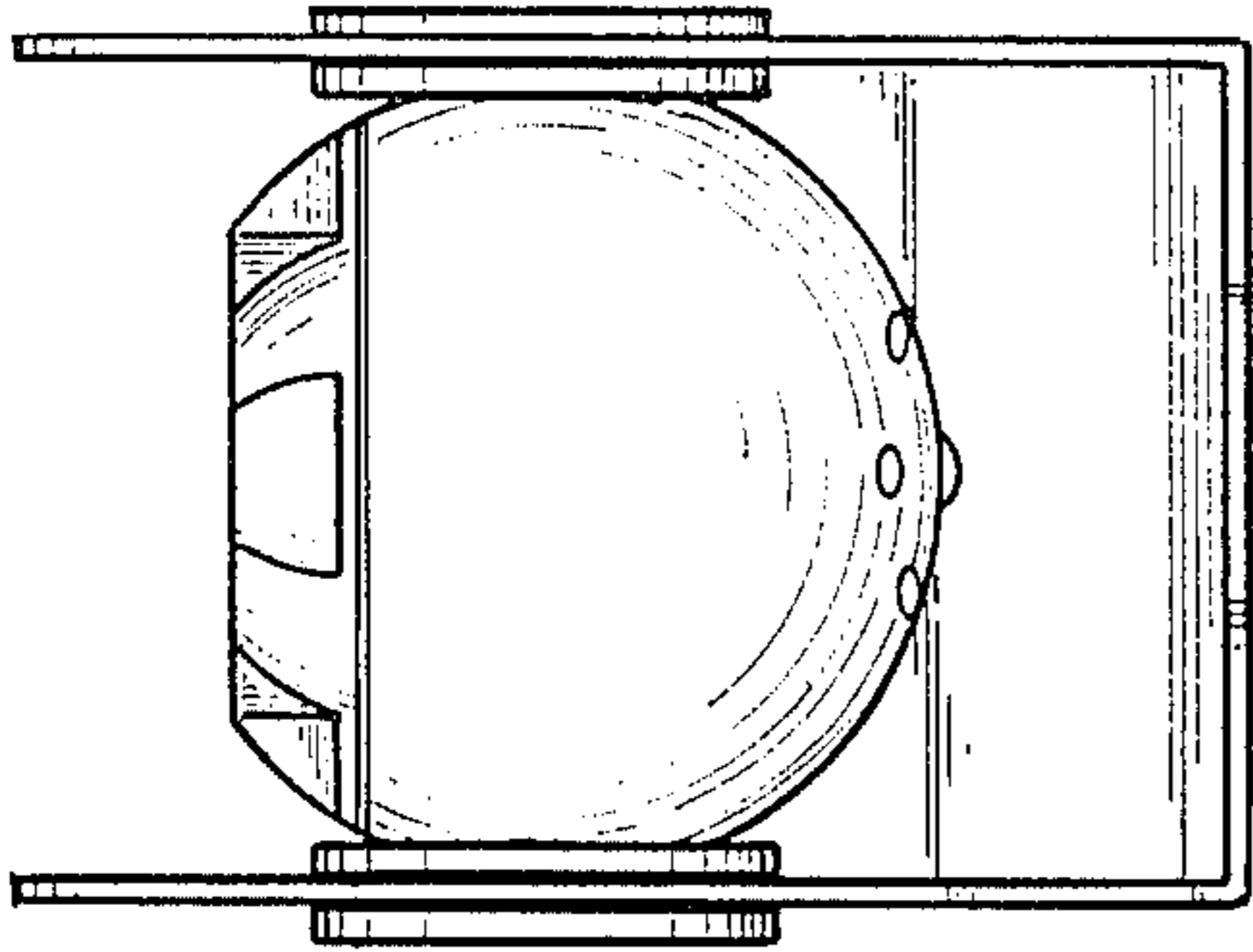

FIG-10

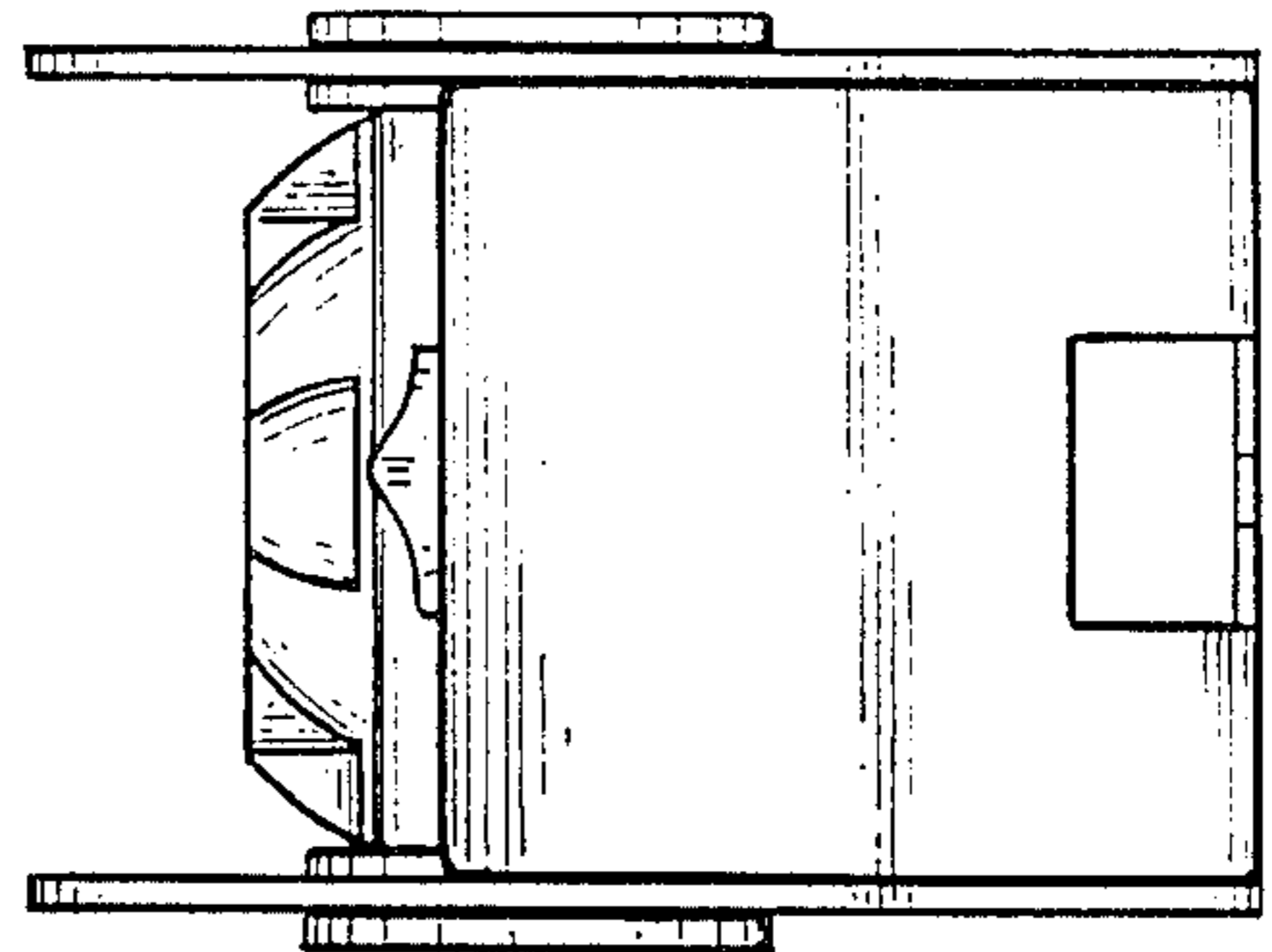

FIG-11

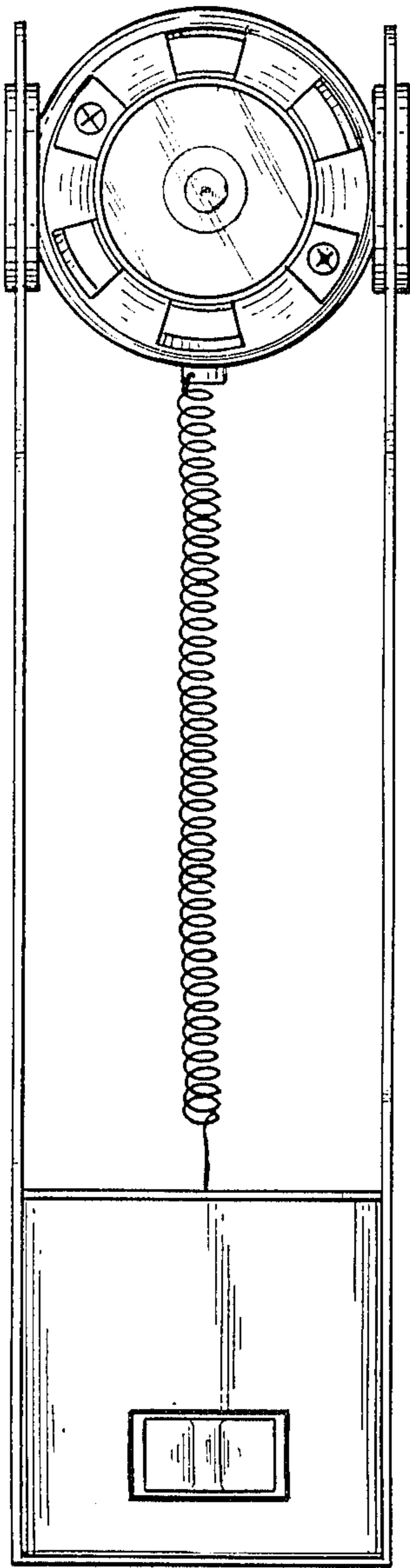

FIG-7

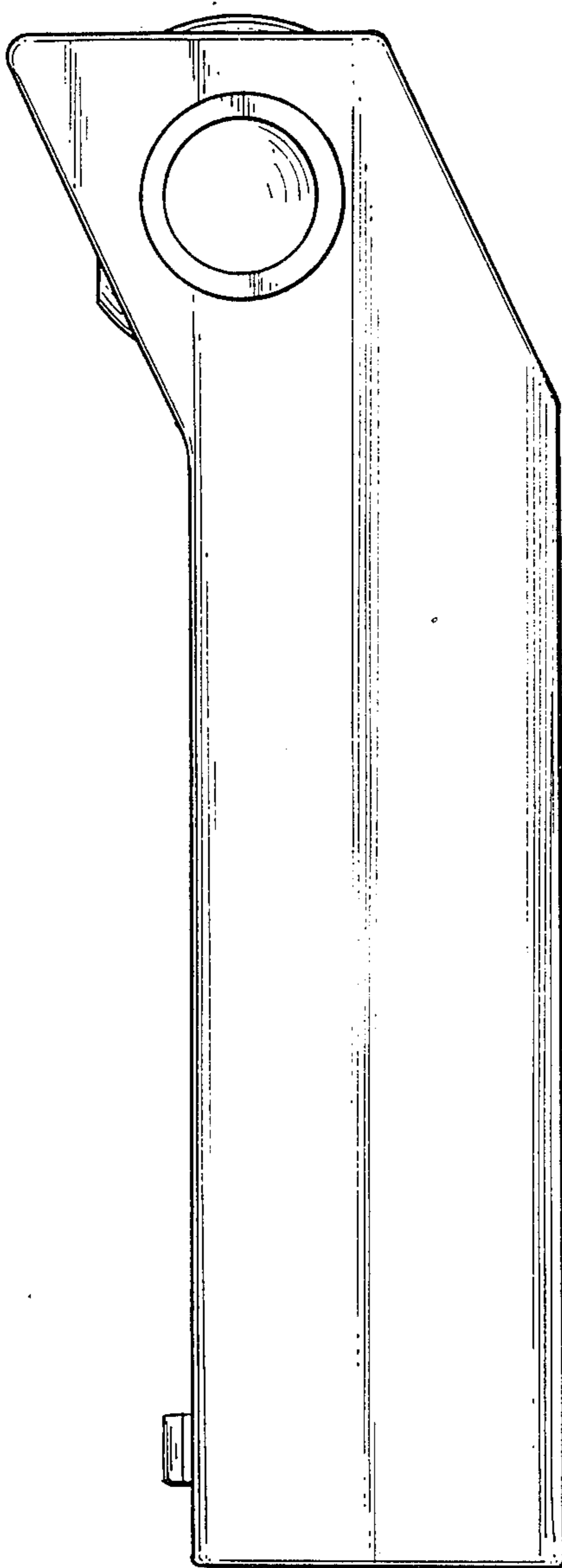

FIG-8

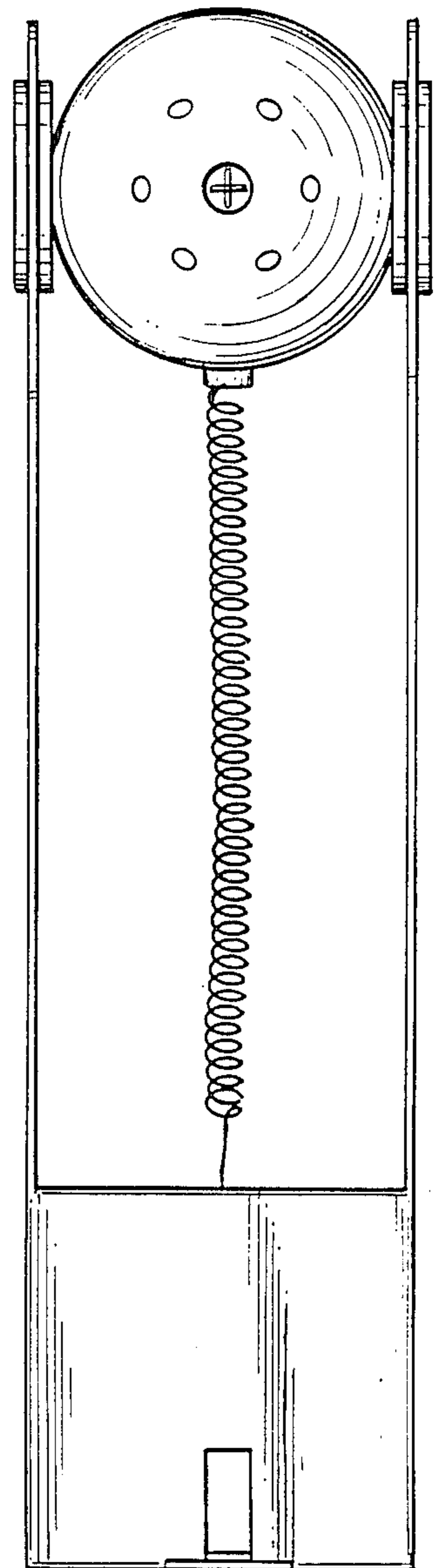

FIG-9