

[54] FLUID TRANSFER NEEDLE

[76] Inventors: Larry E. Brown, 4422 Summerfield Dr.; Wilton W. Lee, 3578 Twin Oaks Dr., both of Napa, Calif. 94558

[\*\*] Term: 14 Years

[21] Appl. No.: 879,173

[22] Filed: Jun. 26, 1986

[52] U.S. Cl. .... D24/53

[58] Field of Search ..... D24/51, 52, 53, 34; 604/81, 126, 127, 246; 137/251.1, 505.16

[56] References Cited

U.S. PATENT DOCUMENTS

D. 270,568 9/1983 Armstrong ..... D24/52

Primary Examiner—Wallace R. Burke

Assistant Examiner—Stella M. Reid

Attorney, Agent, or Firm—Lothrop & West

[57] CLAIM

The ornamental design for a fluid transfer needle, as shown and described.

DESCRIPTION

FIG. 1 is a perspective view of a fluid transfer needle, showing our new design;

FIG. 2 is a front elevational view, thereof;

FIG. 3 is an elevational view of one side, the opposite side elevational view being substantially a mirror image, thereof;

FIG. 4 is a rear elevational view, thereof;

FIG. 5 is a top plan view, thereof;

FIG. 6 is a bottom plan view, thereof; and,

FIG. 7 is a side elevational view thereof, the broken line showing of the bottles is for illustrative purposes only and forms no part of the claimed design.

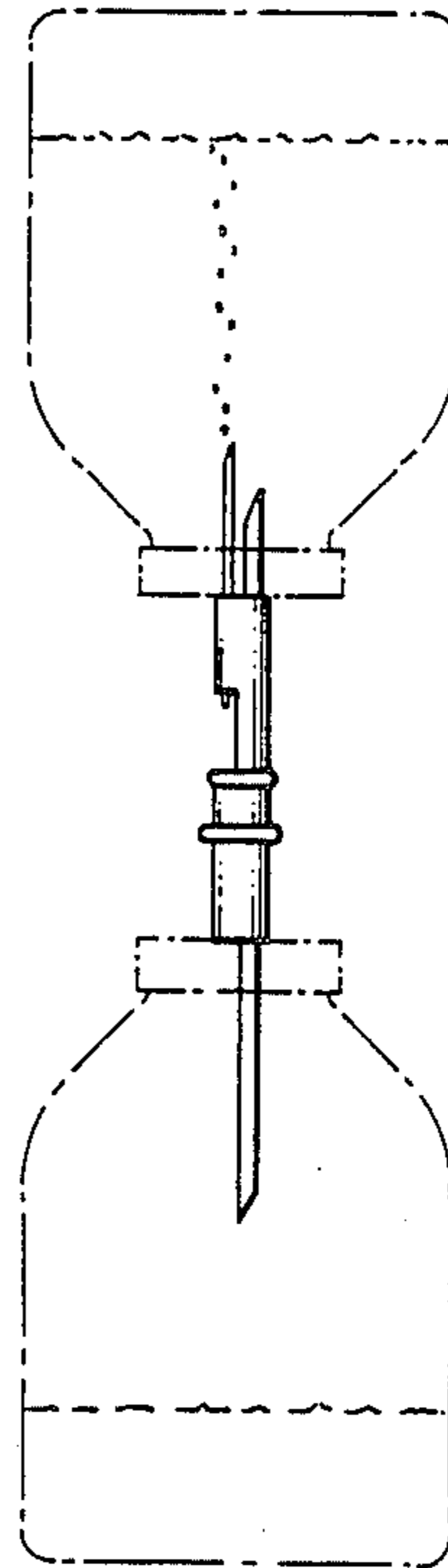
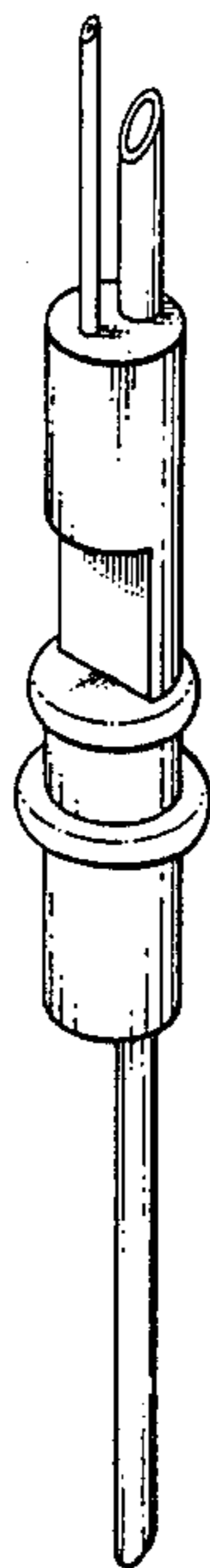

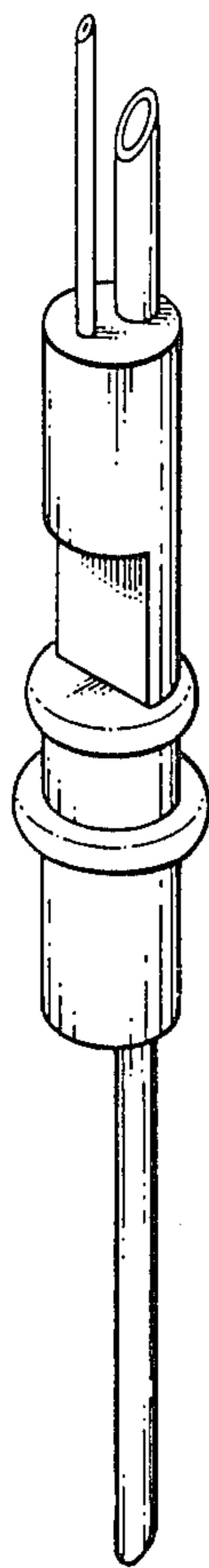

FIG. 1.

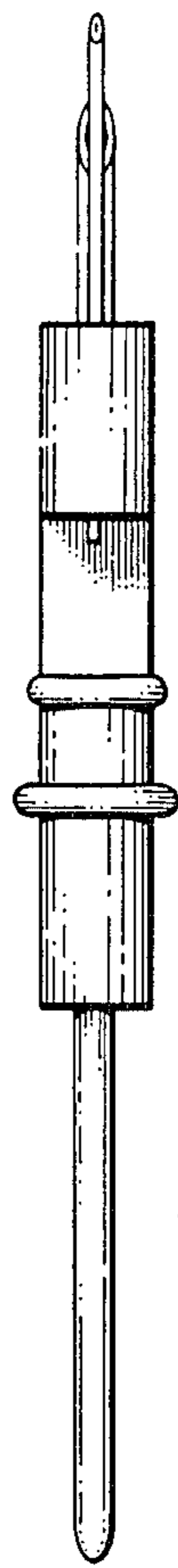

FIG. 2.

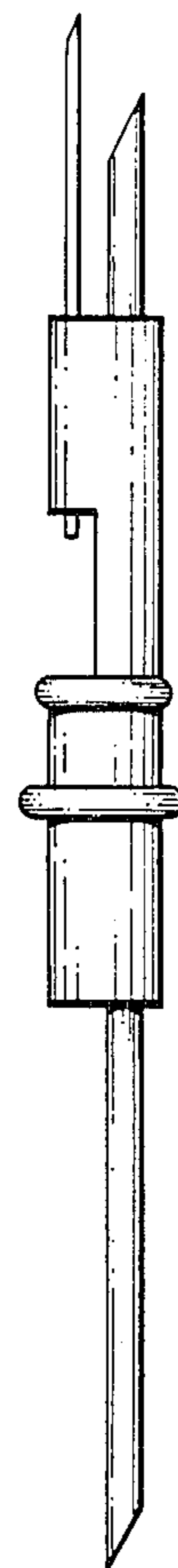

FIG. 3.

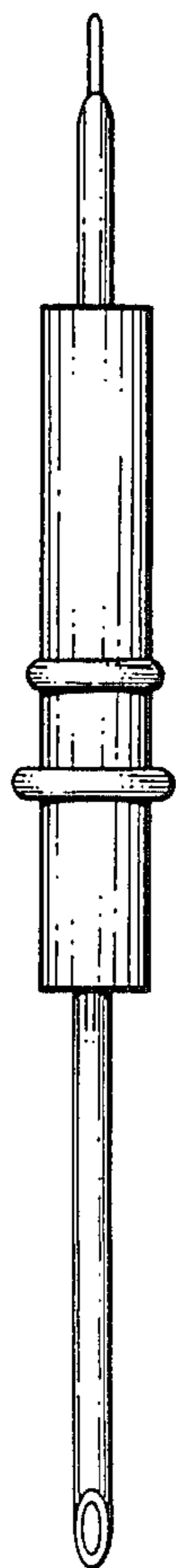

FIG. 4.

FIG. 5.

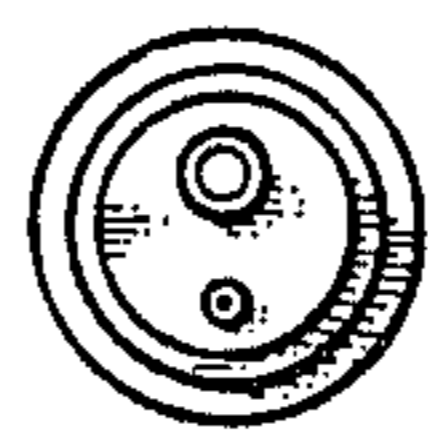

FIG. 6.

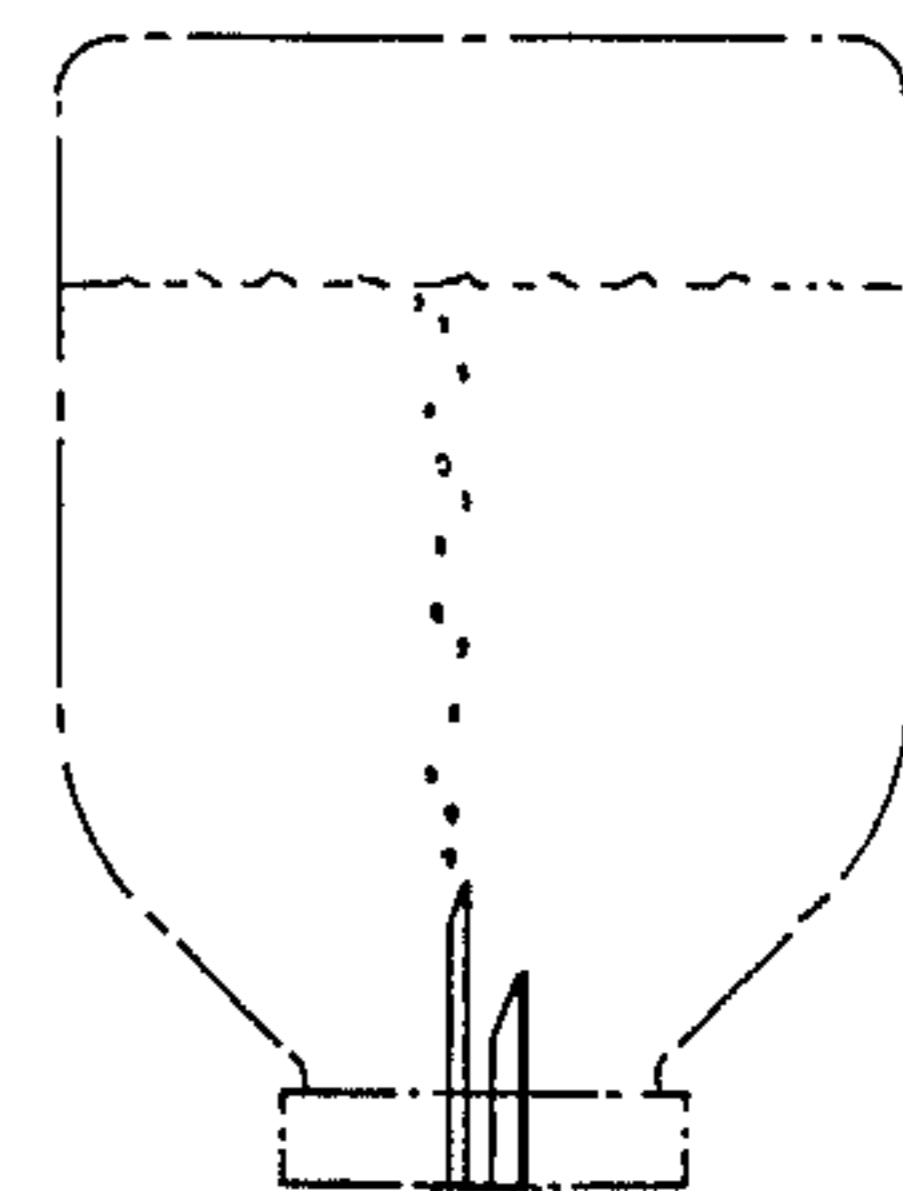
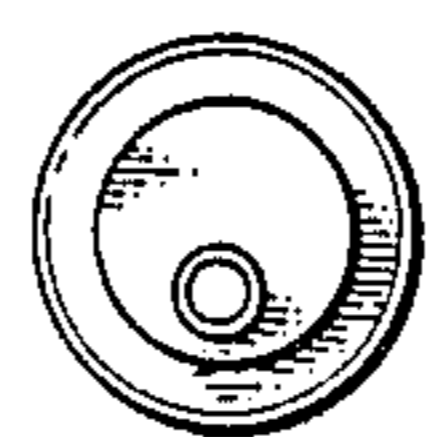

FIG. 7.

