

[54] **COASTER**

[76] **Inventor: Con Papas, 12 Wendy Avenue,
Georges Hall, N.S.W. 2198,
Australia**

[**] **Term: 14 Years**

[21] **Appl. No.: 813,607**

[22] **Filed: Dec. 26, 1985**

[30] **Foreign Application Priority Data**

Jun. 26, 1985 [AU] Australia 1667/85

[52] **U.S. Cl. D21/224; D21/76**

[58] **Field of Search D21/227, 128, 71, 73,
D21/76; 280/87.01, 87.04 R**

[56] **References Cited**

U.S. PATENT DOCUMENTS

3,310,319 3/1967 Collins D21/227
3,399,904 9/1968 Schinke D21/227

3,482,334 12/1969 Jacobus D21/227

OTHER PUBLICATIONS

Playthings, 2-1970, p. 114, Skateboard at top of page.

Primary Examiner—Charles A. Rademaker

[57] **CLAIM**

The ornamental design for a coaster, as shown.

DESCRIPTION

FIG. 1 is a top plan view of a coaster showing my new design;

FIG. 2 is an end elevational view thereof taken along arrows 2—2 in FIG. 1;

FIG. 3 is a side elevational view thereof, the side opposite being a mirror image;

FIG. 4 is a bottom plan view thereof;

FIG. 5 is an end elevational view thereof taken along arrows 5—5 in FIG. 4; and

FIG. 6 is a top perspective view thereof.

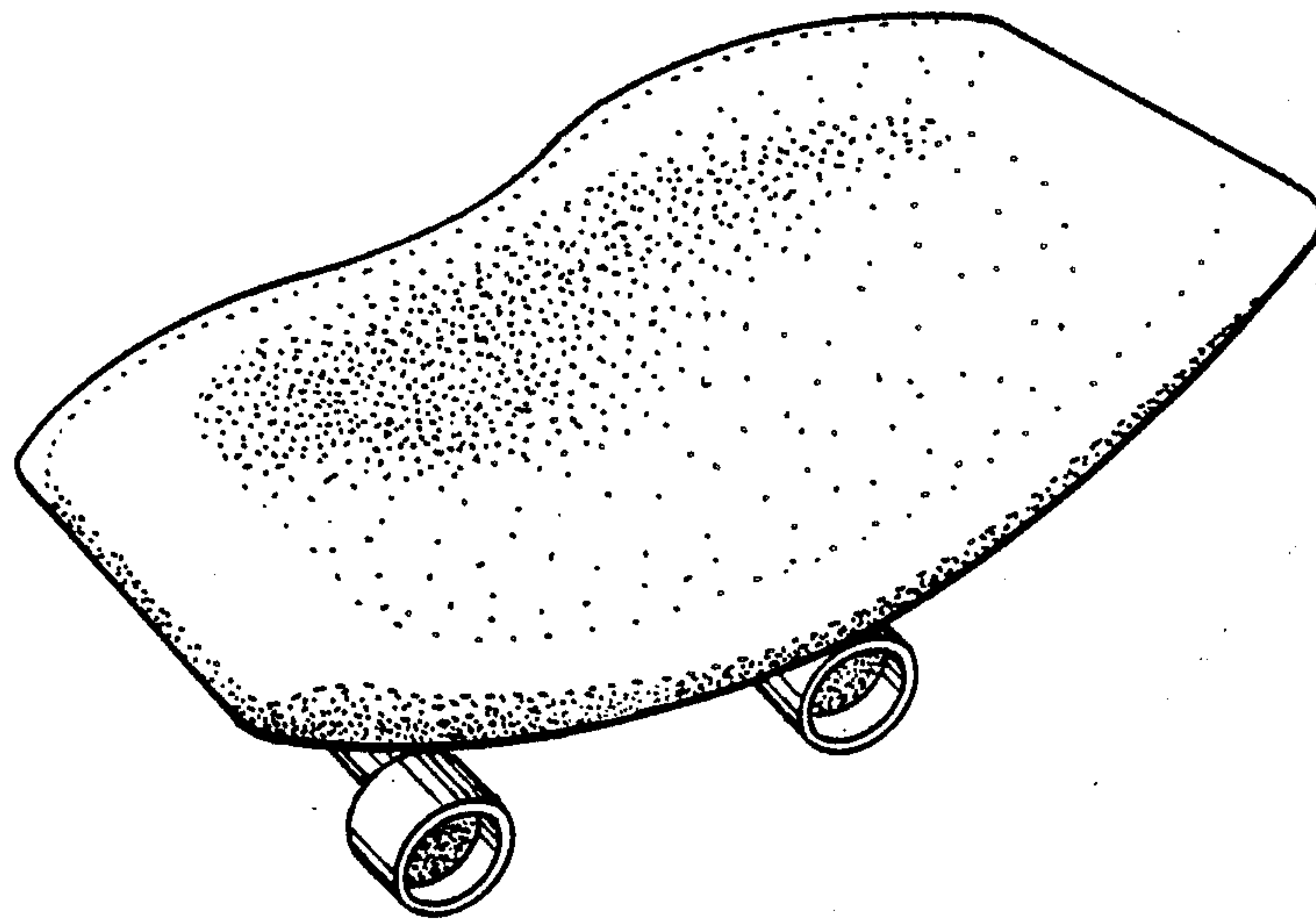

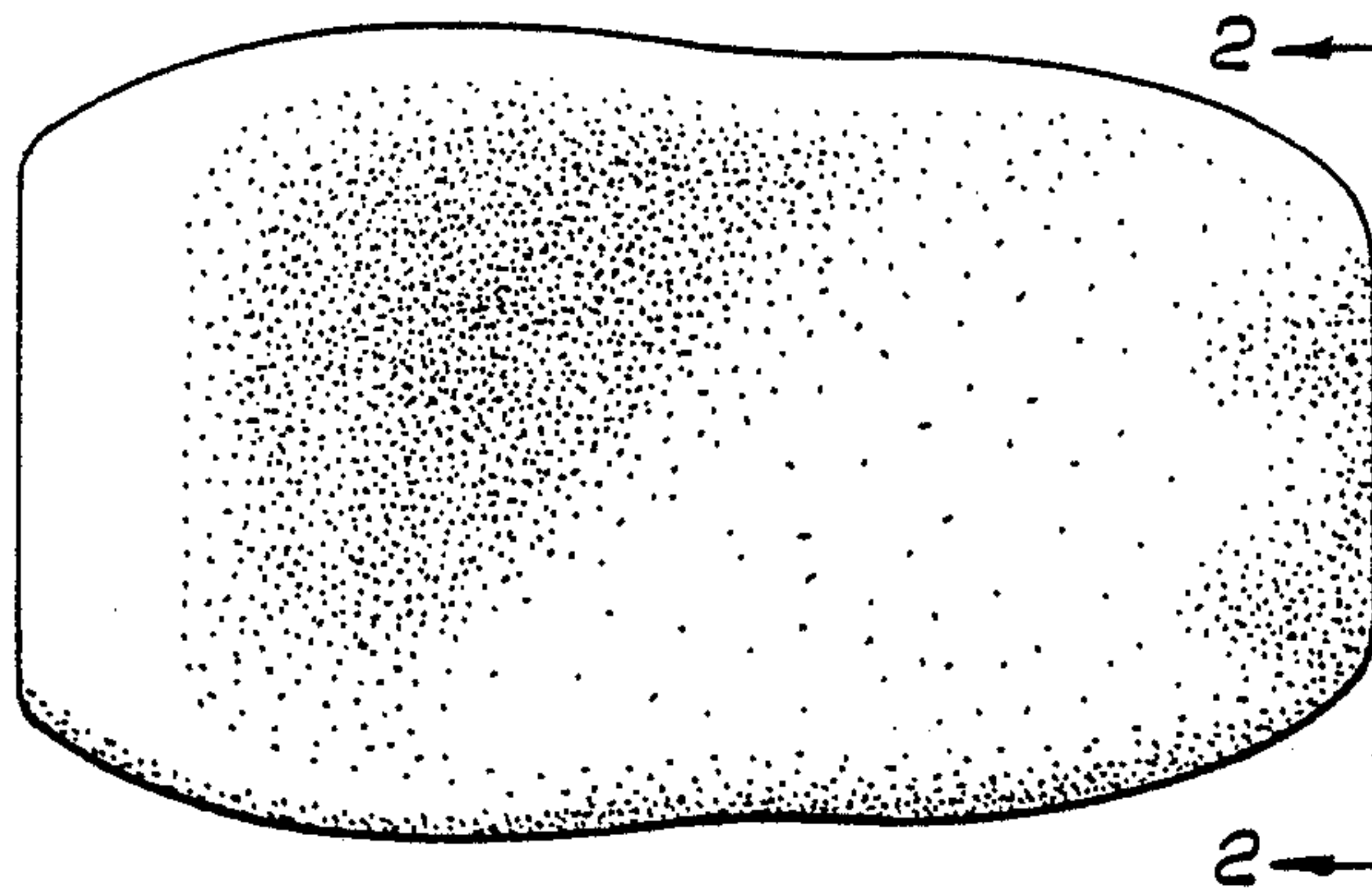

FIG. 1

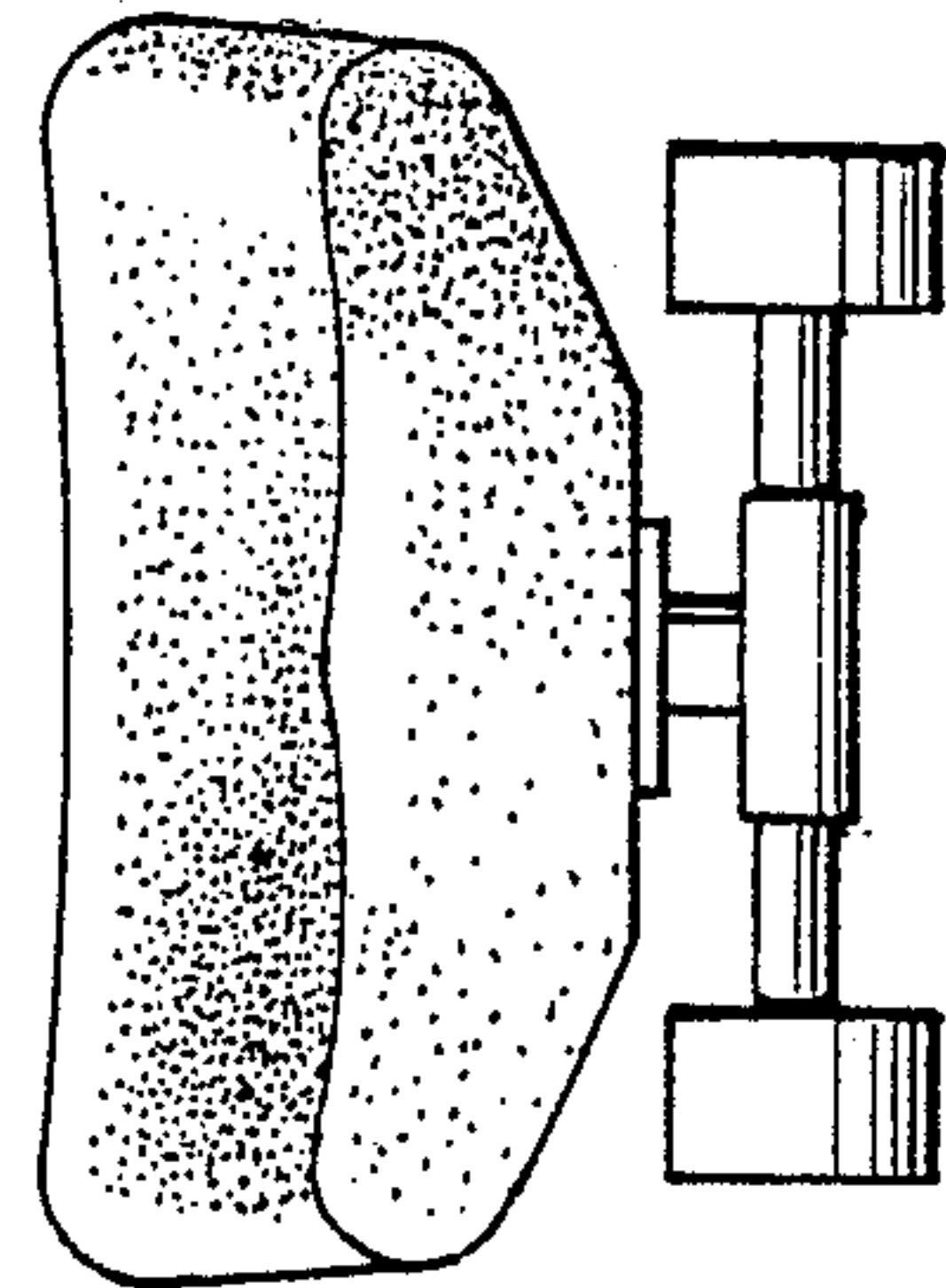

FIG. 2

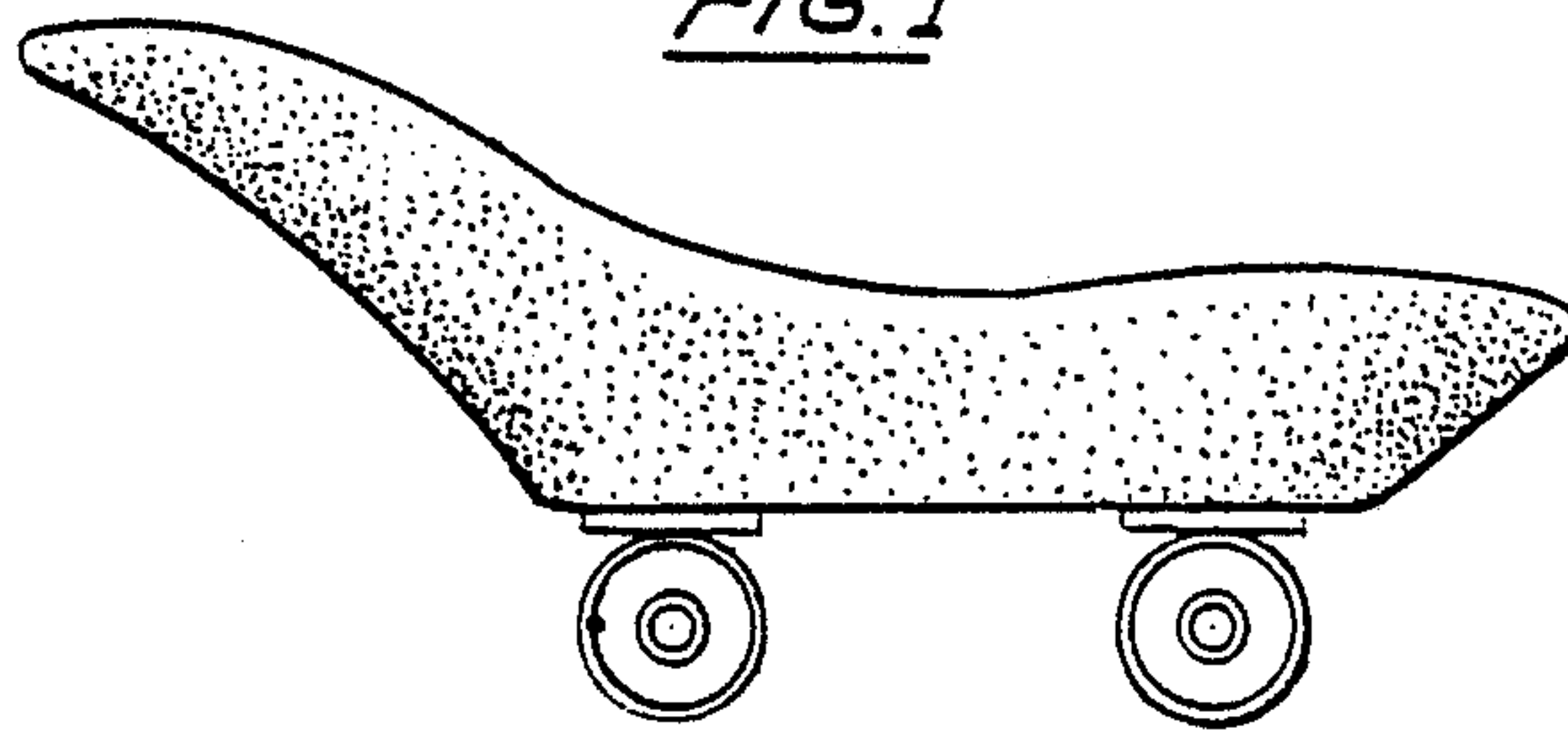

FIG. 3

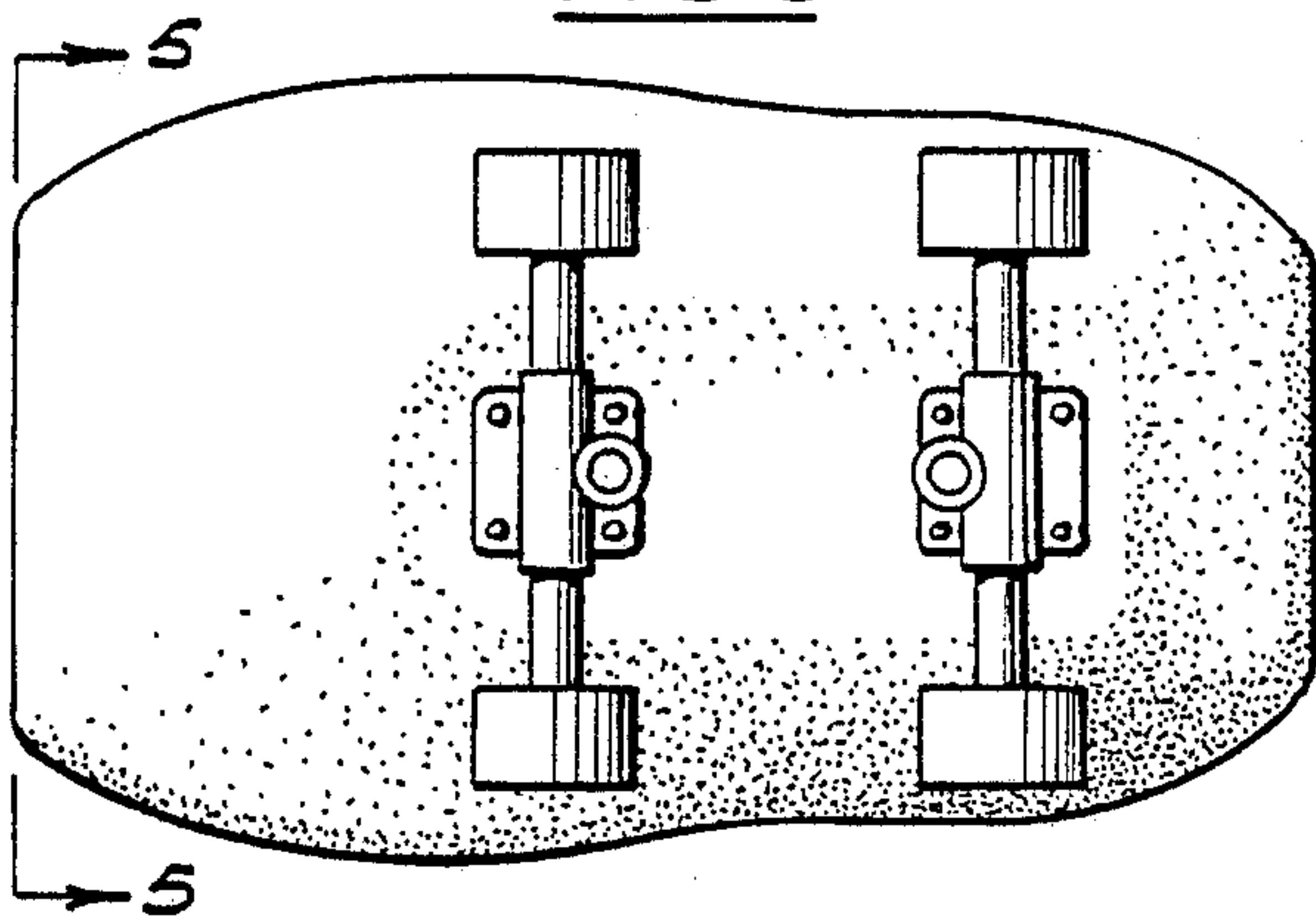

FIG. 4

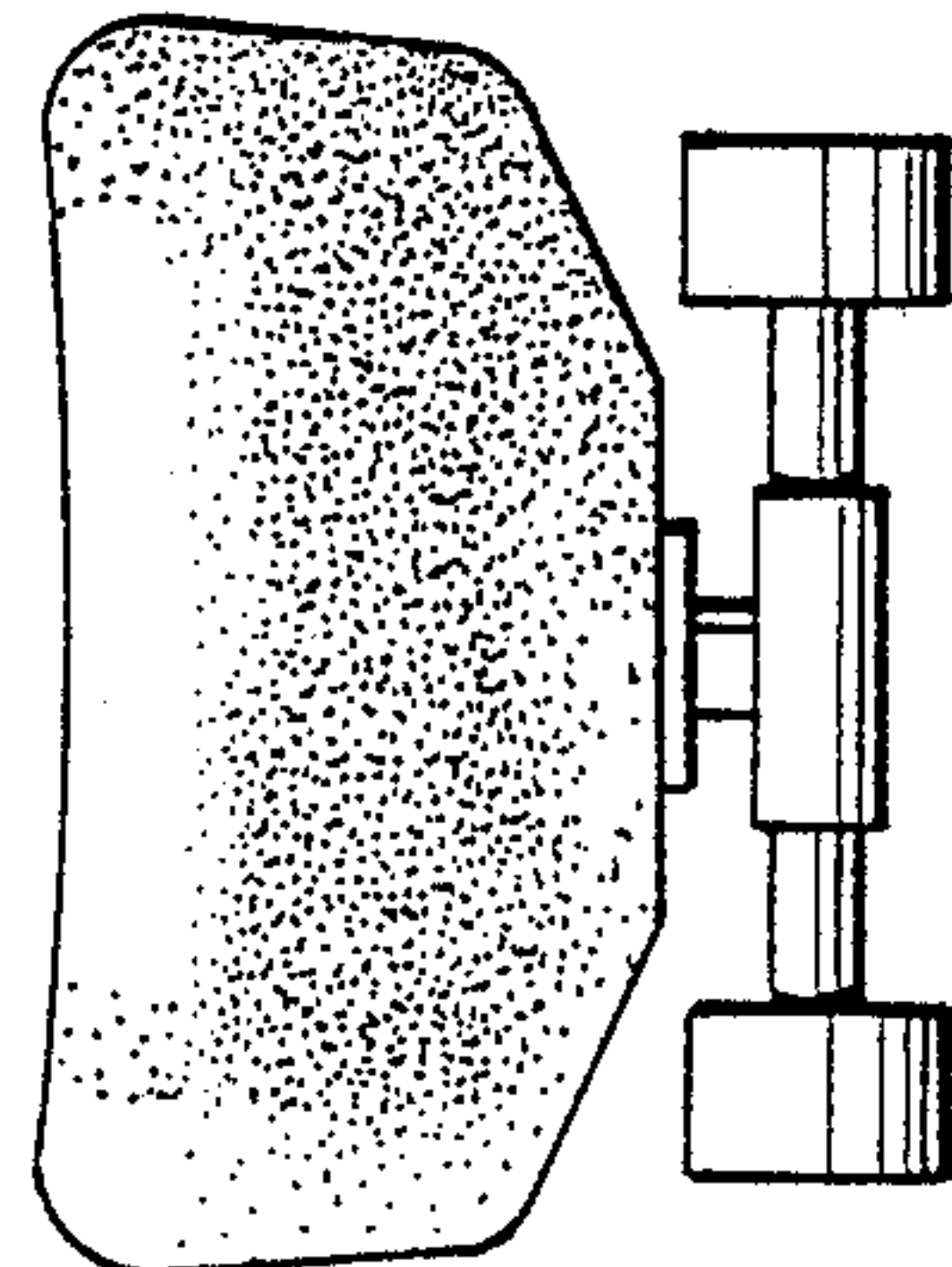

FIG. 5

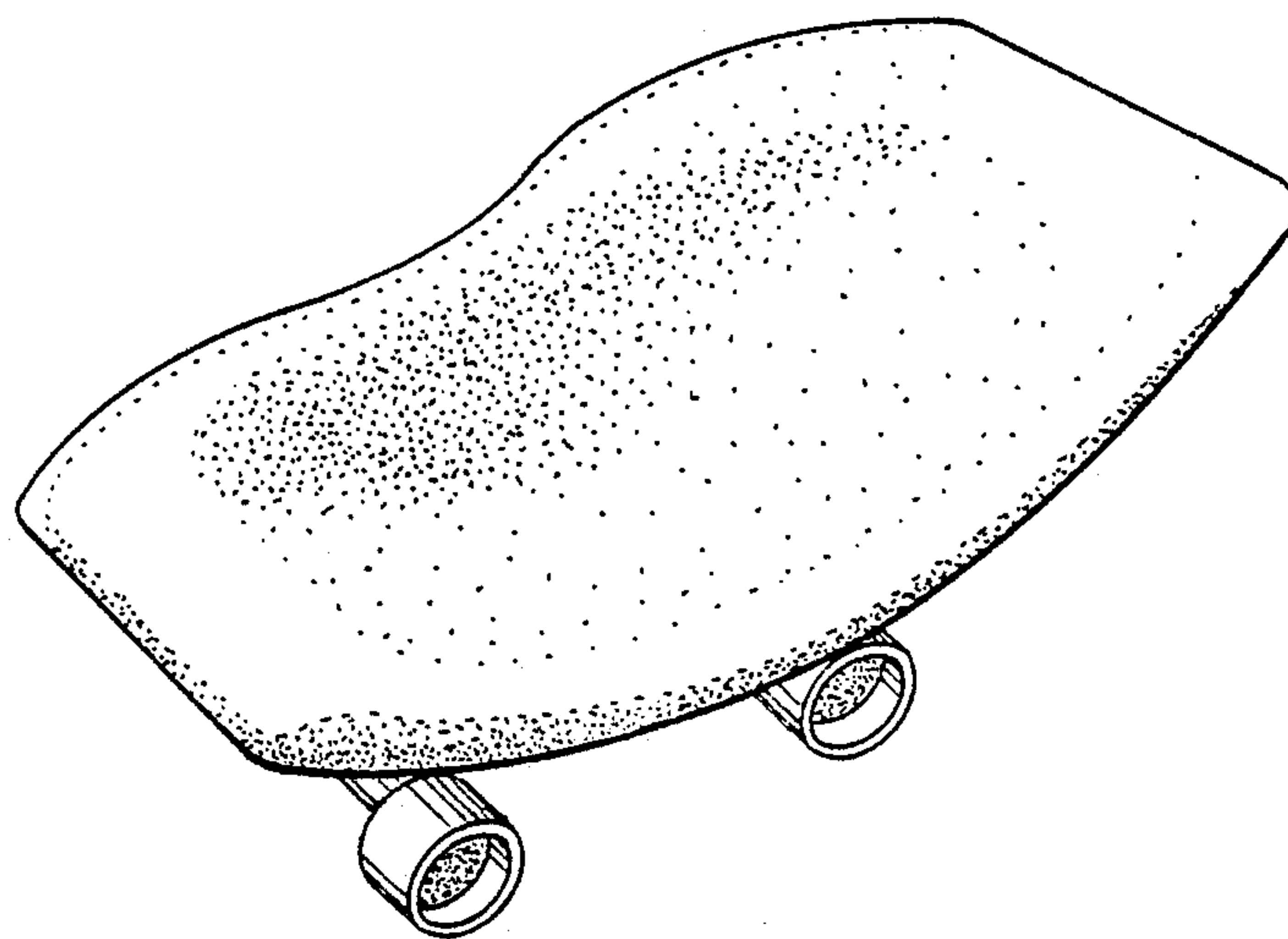

FIG. 6