

[54] DISPLAY STAND

[75] Inventor: Lynn E. Everett, New Philadelphia, Ohio

[73] Assignee: Tusco Manufacturing Company, Gnadenhutten, Ohio

[**] Term: 14 Years

[21] Appl. No.: 884,557

[22] Filed: Jul. 11, 1986

[52] U.S. Cl. D6/415; D6/455

[58] Field of Search D6/411, 412, 413, 414, D6/415, 455, 457, 458; 211/13, 205

[56] References Cited

U.S. PATENT DOCUMENTS

- D. 153,686 5/1949 Hinkle D6/411
- D. 224,496 8/1972 Kodinsky D6/455
- D. 228,538 10/1973 Cohen D6/458

- D. 228,541 10/1973 Cohen D6/455
- D. 229,382 11/1973 Cohen D6/411 X
- D. 263,358 3/1982 Winter et al. D6/414 X

Primary Examiner—Carmen H. Vales
Attorney, Agent, or Firm—Marshall & Melhorn

[57] CLAIM

The ornamental design for a display stand, as shown and described.

DESCRIPTION

FIG. 1 is a perspective view of a display stand showing my new design;

FIG. 2 is a top plan view thereof;

FIG. 3 is a front elevational view thereof;

FIG. 4 is a rear elevational view thereof;

FIG. 5 is an elevational view thereof taken along line 5—5 of FIG. 2; and

FIG. 6 is an elevational view taken along line 6—6 of FIG. 2.

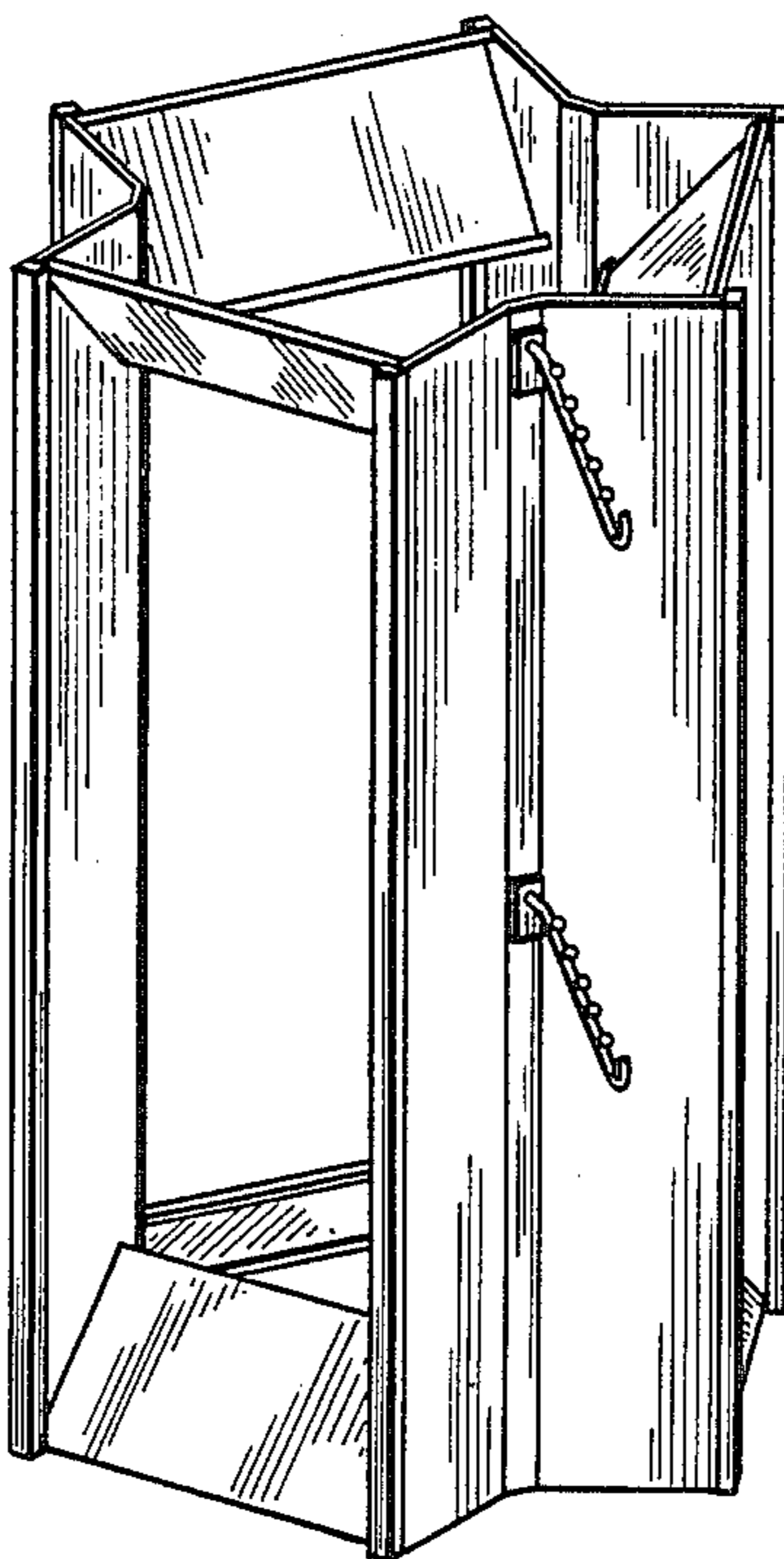

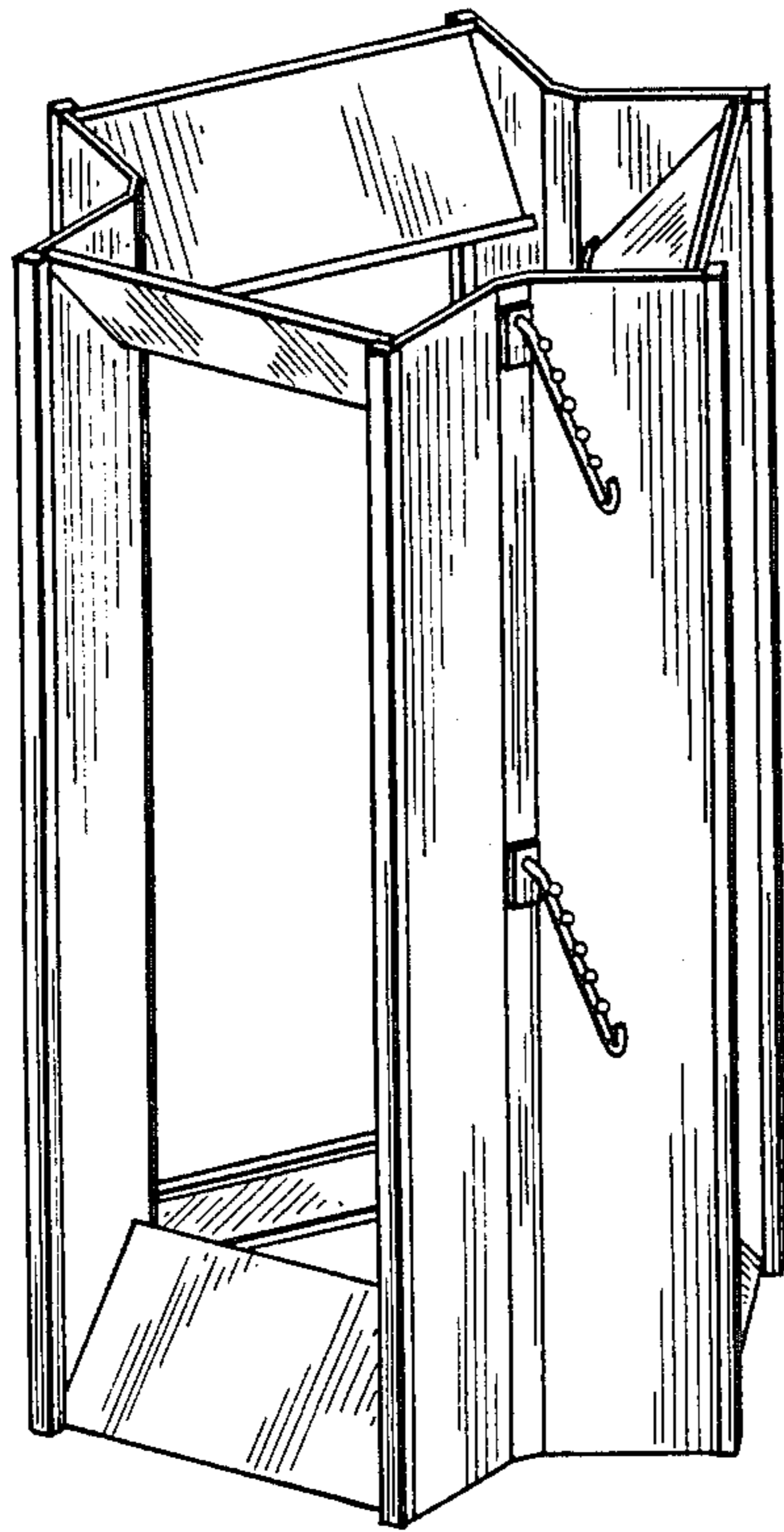

FIG. 1

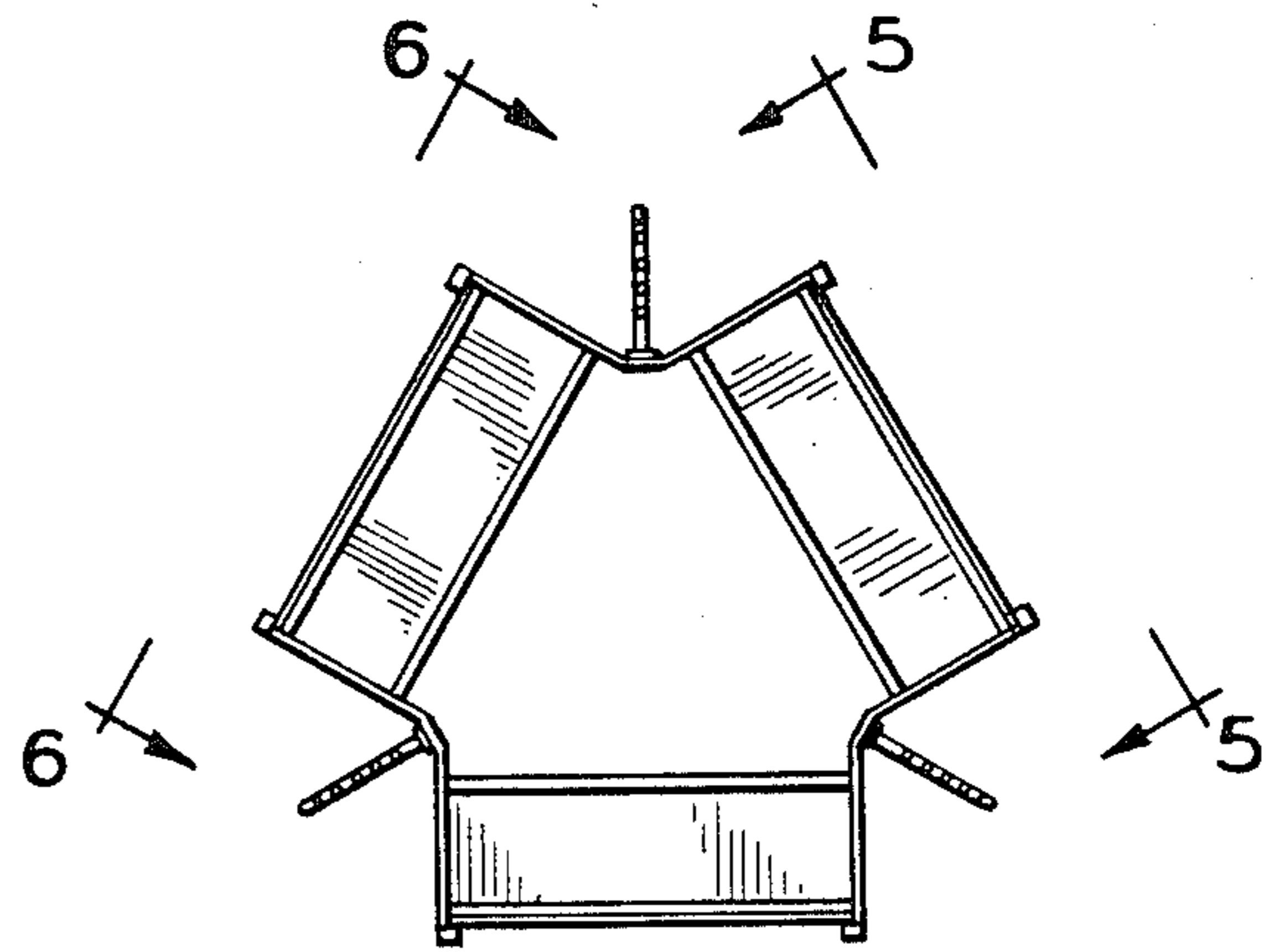

FIG. 2

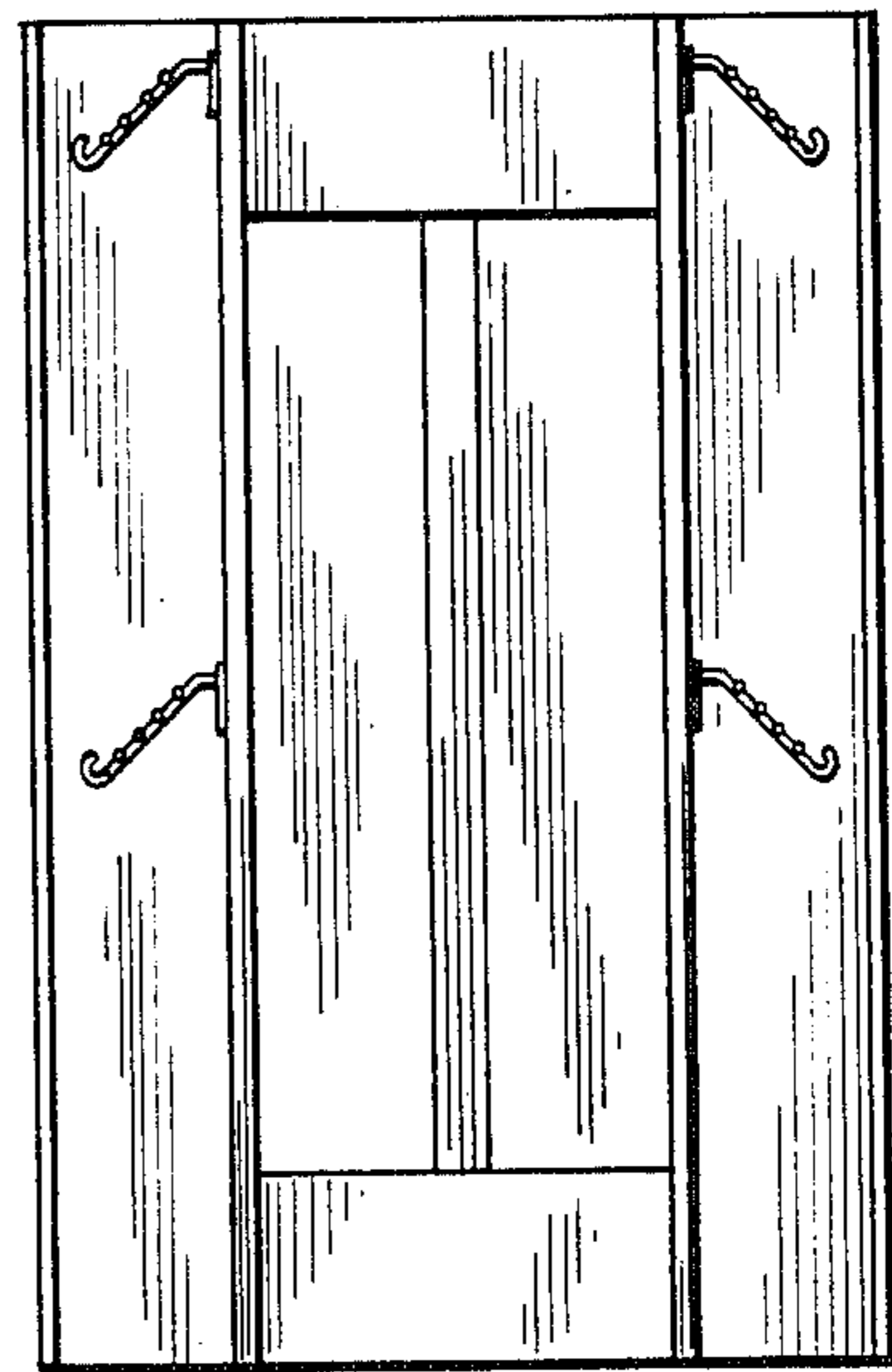

FIG. 3

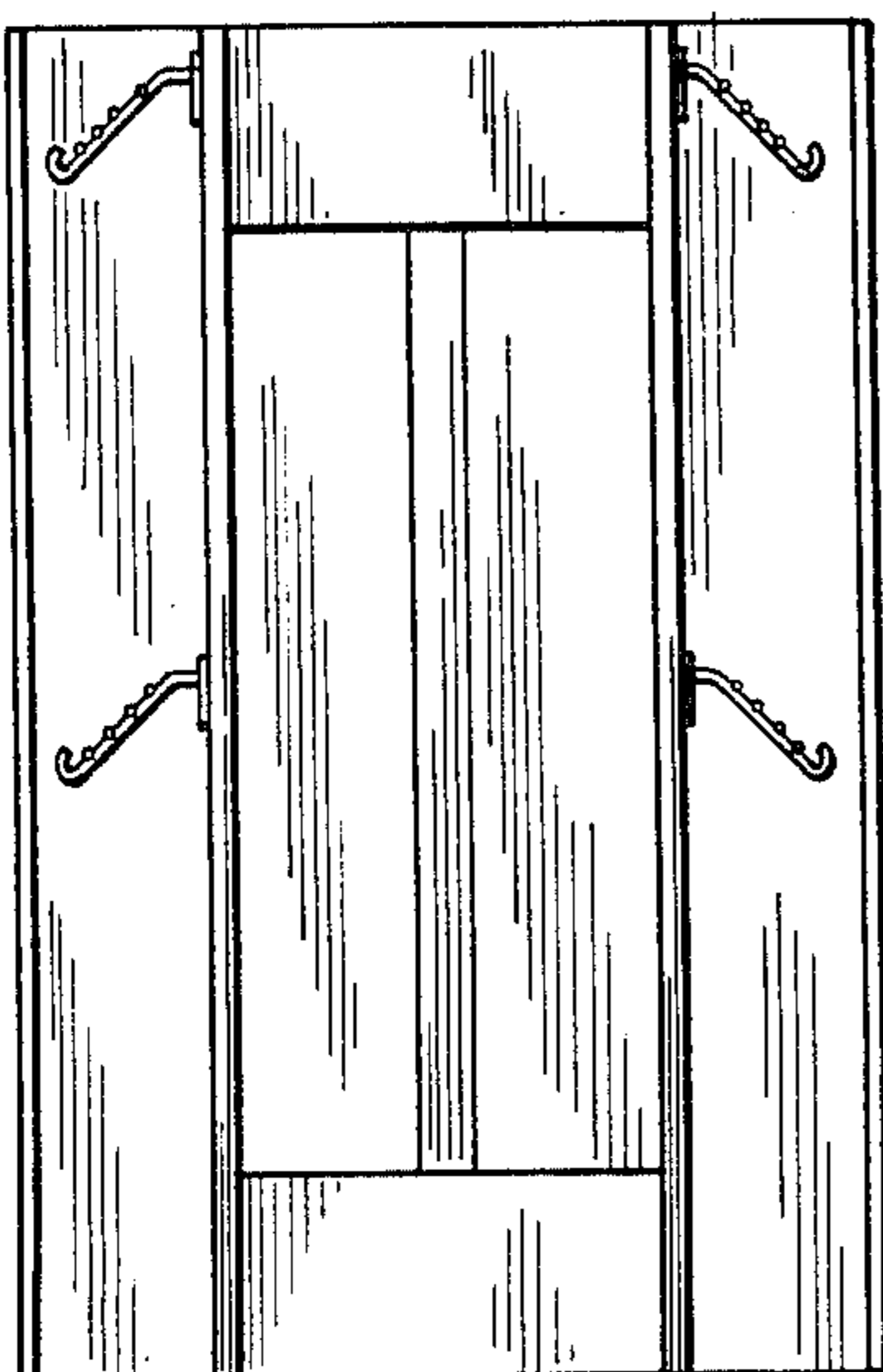

FIG. 5

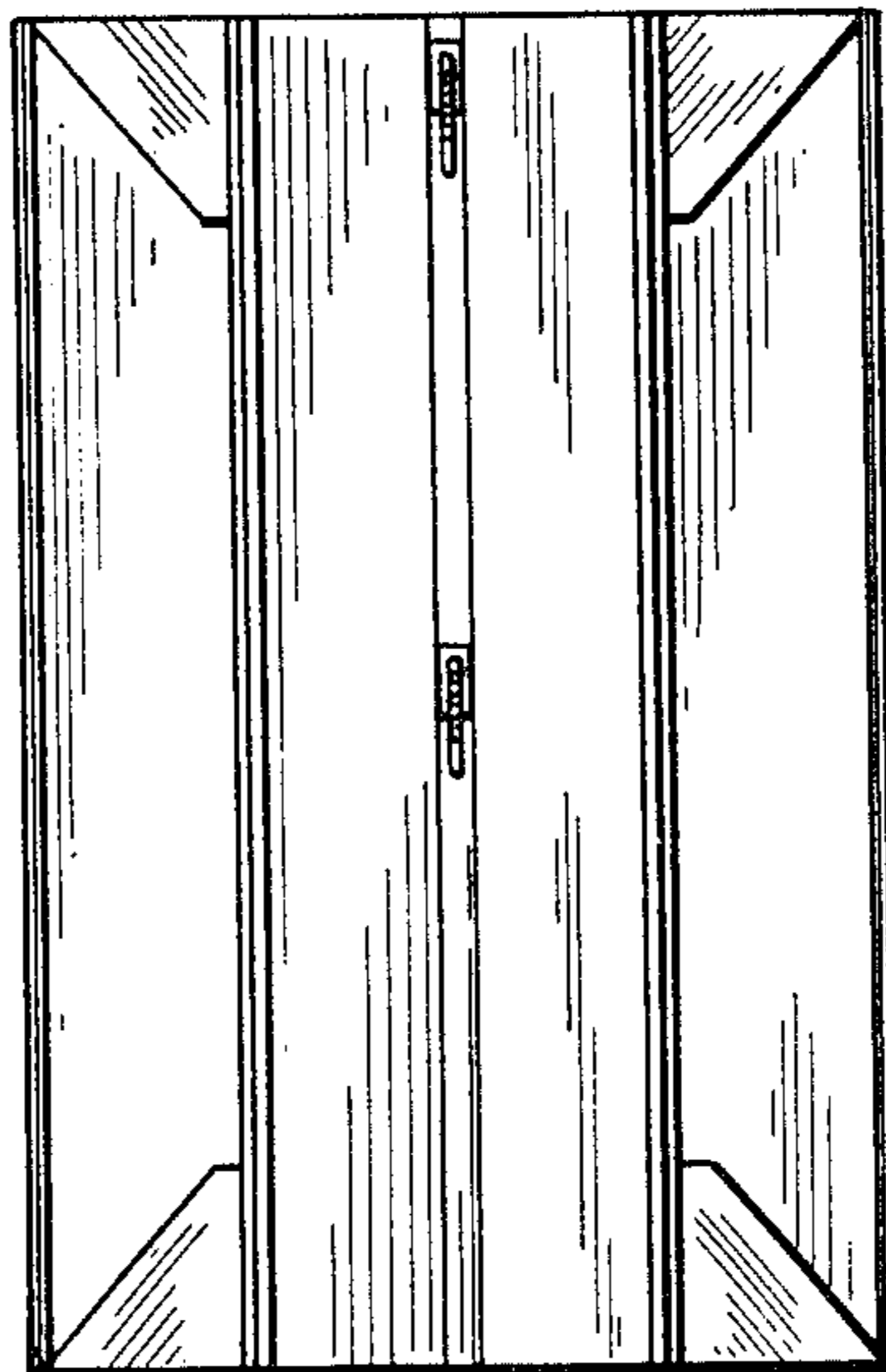

FIG. 4

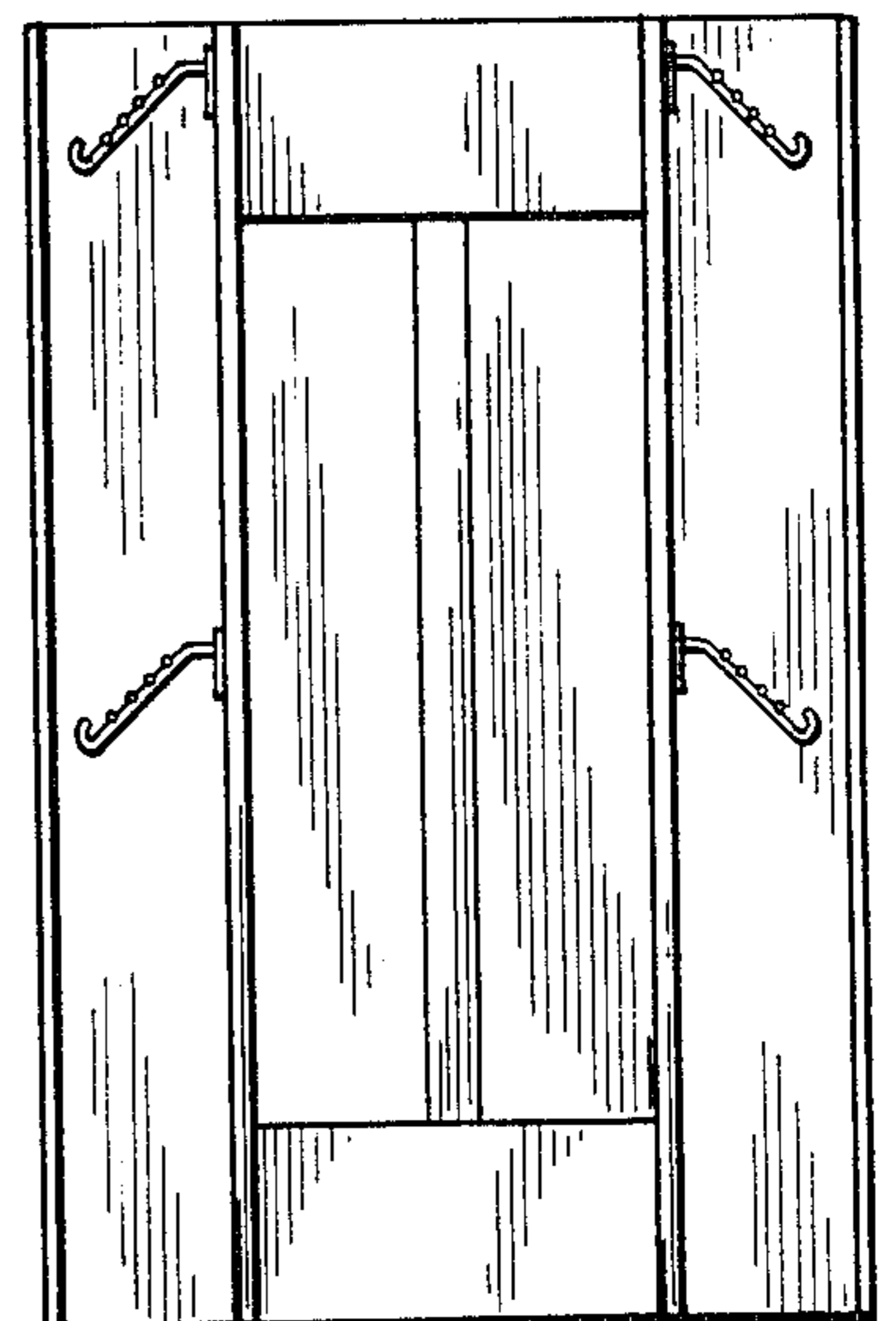

FIG. 6