

- [54] **COMBINED FOUNTAIN BRUSH APPLICATOR BOTTLE AND CAP THEREFOR**
- [75] Inventors: **Ugo Campello; Enrico Racca**, both of Miami, Fla.; **Robert Ryan**, Wall, N.J.
- [73] Assignee: **New High Glass**, Miami, Fla.
- [\*\*] Term: **14 Years**
- [21] Appl. No.: **918,369**
- [22] Filed: **Oct. 14, 1986**
- [52] U.S. Cl. .... **D28/7; D4/114; D28/77**
- [58] Field of Search ..... **D4/114; D24/63; D28/4-8, 56, 63, 76-91, 99; D9/337, 338, 377; 132/79 R-79 D, 88.5, 88.7, DIG. 3; 15/244.1; 401/101, 115, 269, 274**

[56] **References Cited**  
**U.S. PATENT DOCUMENTS**

D. 175,548	9/1955	Kane	.....	D4/114
D. 252,911	9/1979	Levy	.....	D28/7 X
2,872,694	2/1959	Hopkins	.....	401/115
3,420,611	1/1969	Towns	.....	401/115
3,877,822	4/1975	LaMura	.....	401/101
3,924,646	12/1975	LaMura	.....	132/79 R
4,063,829	12/1977	LaMura	.....	401/101

4,710,048 12/1987 Vartinghian ..... 401/269

**FOREIGN PATENT DOCUMENTS**

45690 2/1982 European Pat. Off. .... 401/274

**OTHER PUBLICATIONS**

The American Boutique, 1979, p. 30-Jonel Perfume Bottles.

Primary Examiner—Louis S. Zarfes  
Attorney, Agent, or Firm—Anthony J. Casella; Gerald E. Hespos

[57] **CLAIM**

The ornamental design of combined fountain brush applicator bottle and cap therefor, as shown and described.

**DESCRIPTION**

FIG. 1 is an exploded perspective view of a combined fountain brush applicator bottle and cap therefor showing our new design in inverted position;  
 FIG. 2 is a top plan view with the cap removed;  
 FIG. 3 is a front elevational view thereof;  
 FIG. 4 is a side elevational view thereof;  
 FIG. 5 is a bottom plan view;  
 FIG. 6 is a front elevational view with the cap in place;  
 and,  
 FIG. 7 is a top plan view thereof.

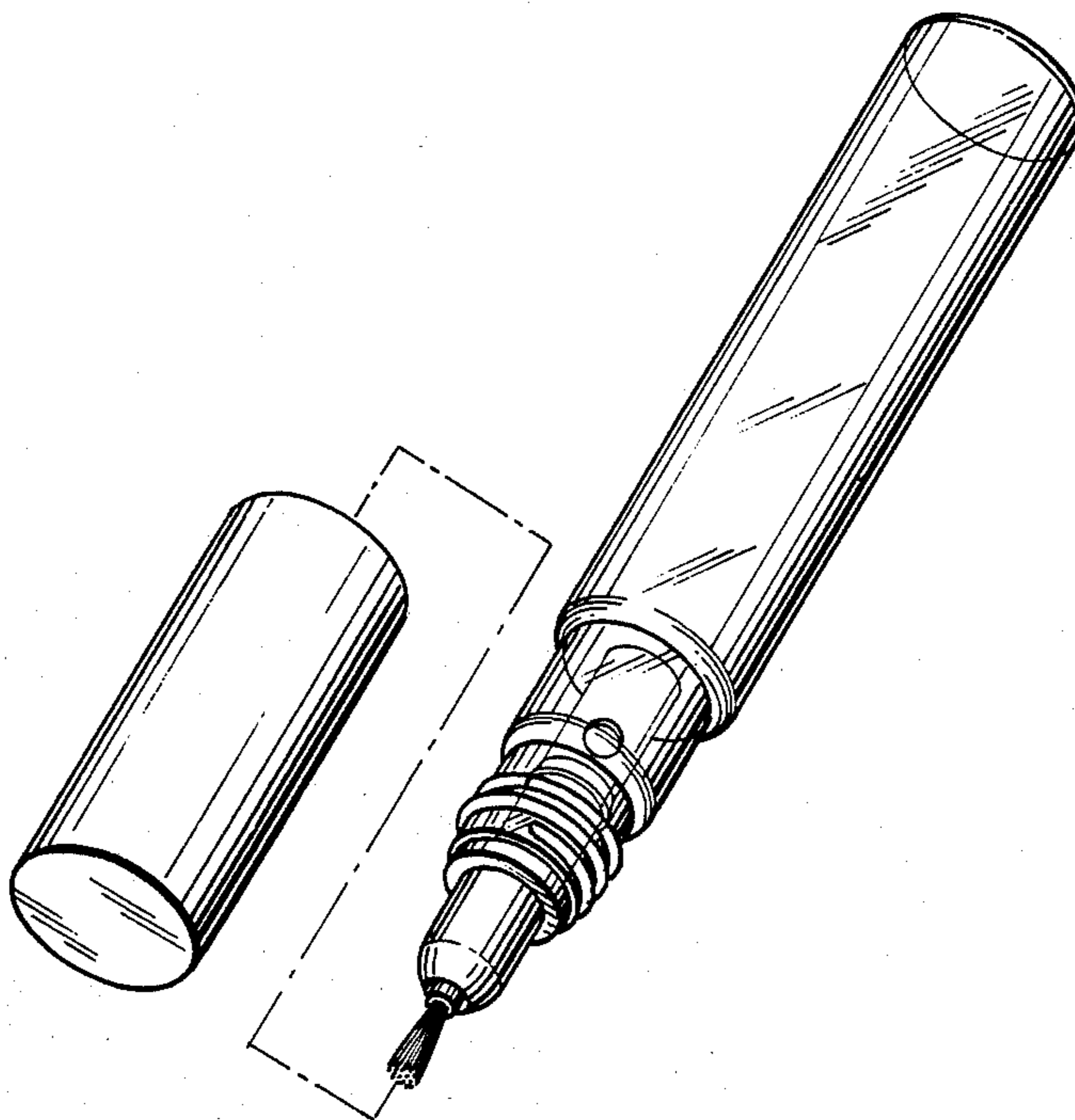

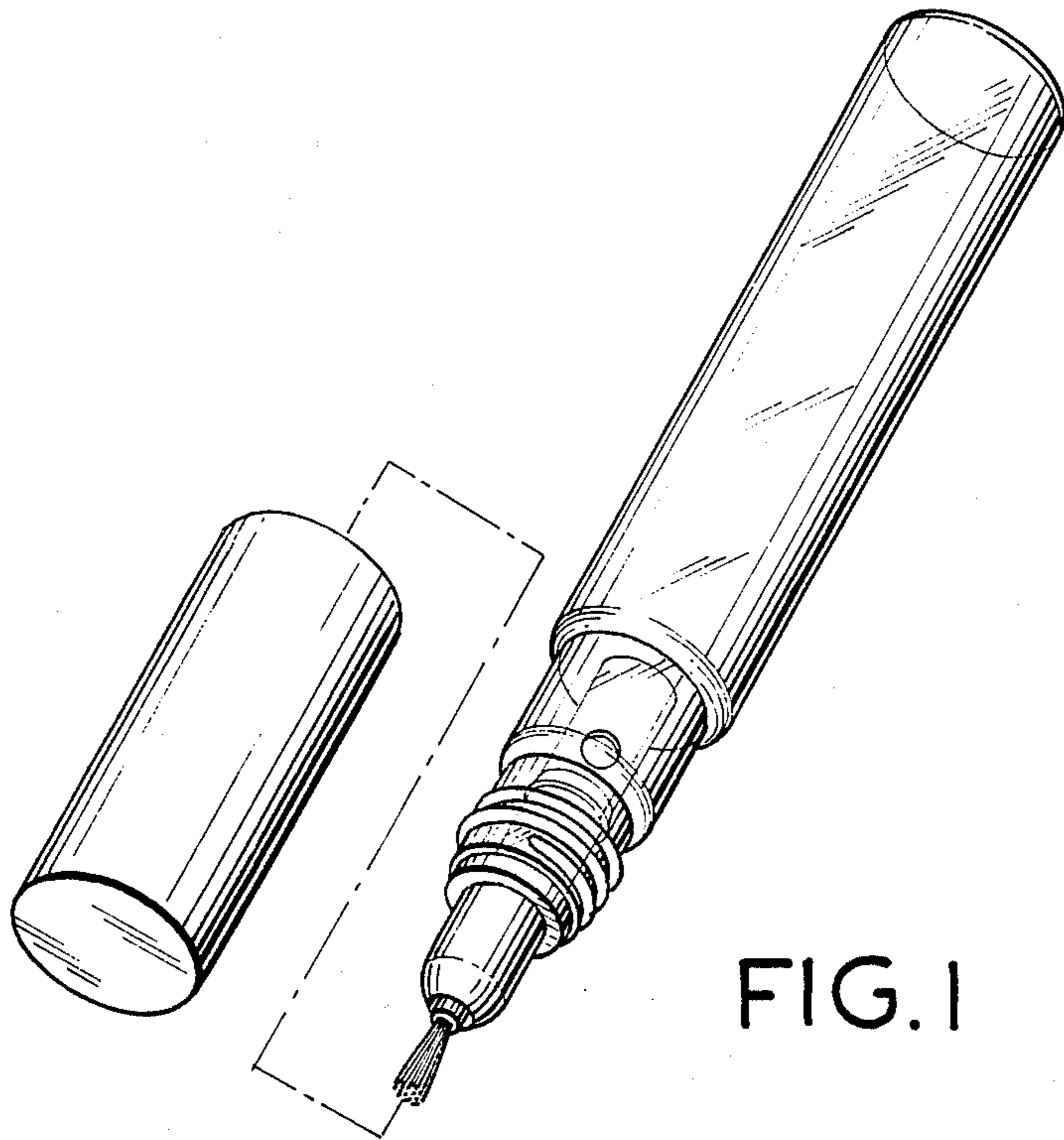

FIG. 1

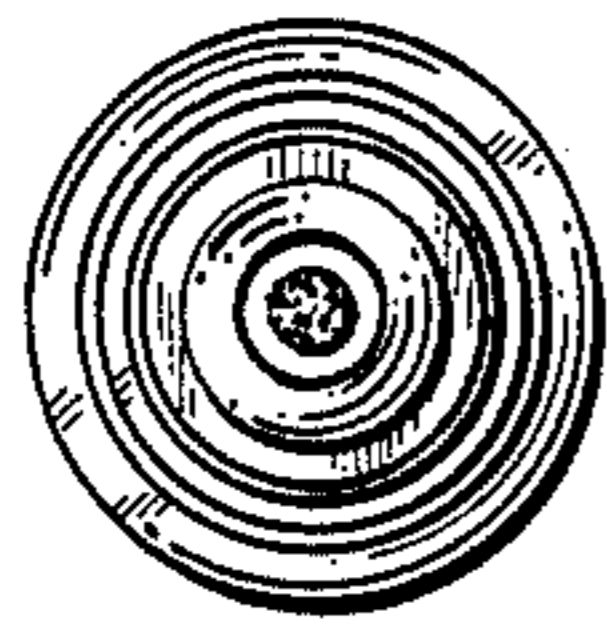

FIG. 2

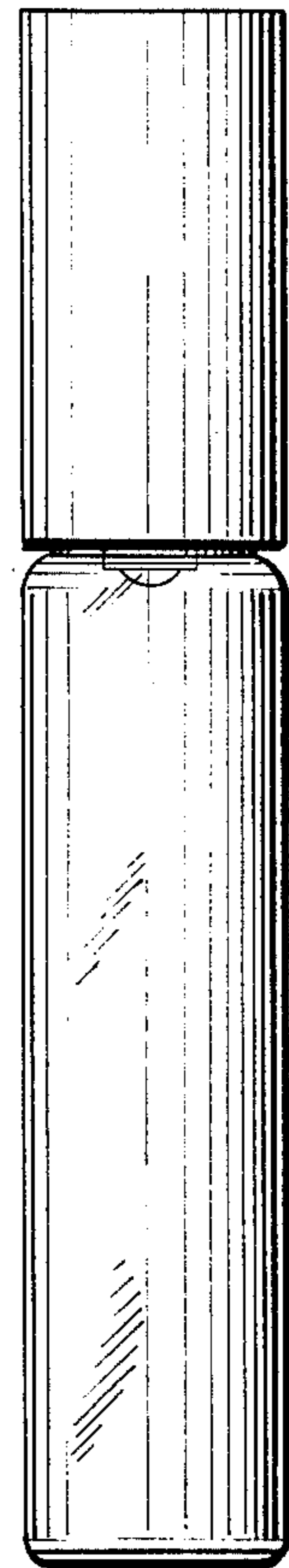

FIG. 6

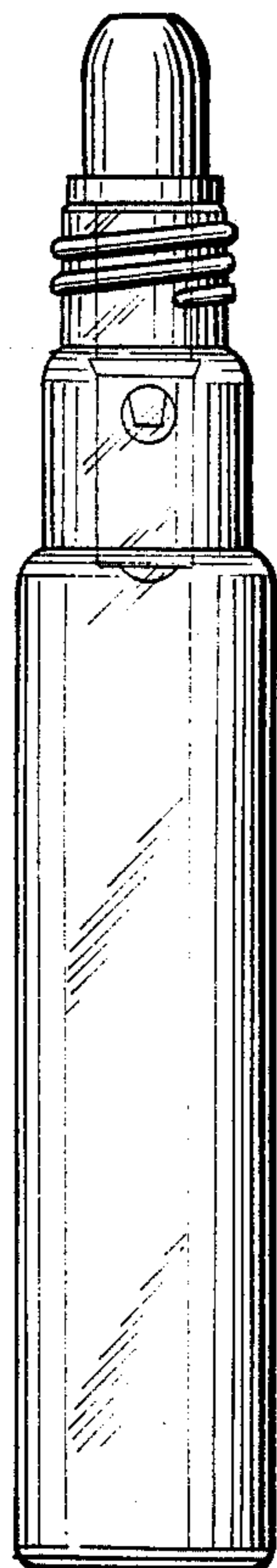

FIG. 3

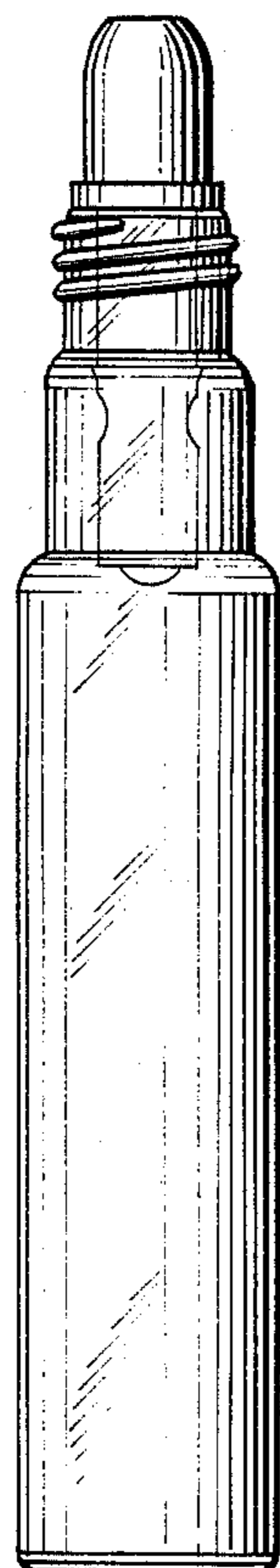

FIG. 4

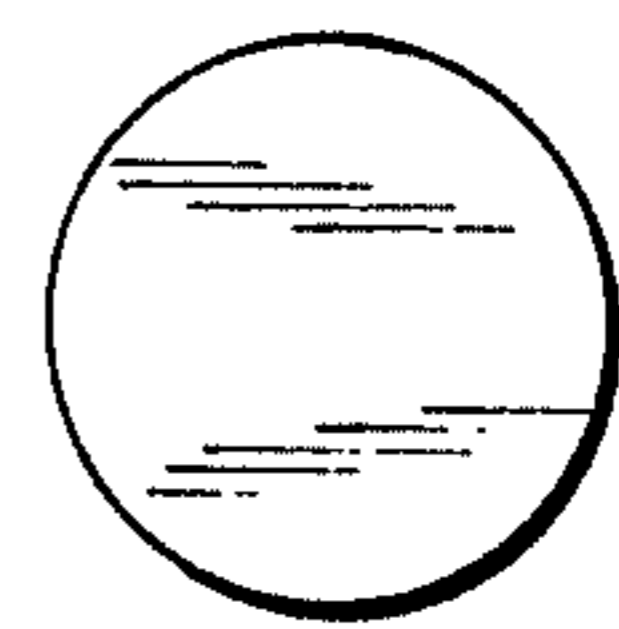

FIG. 7

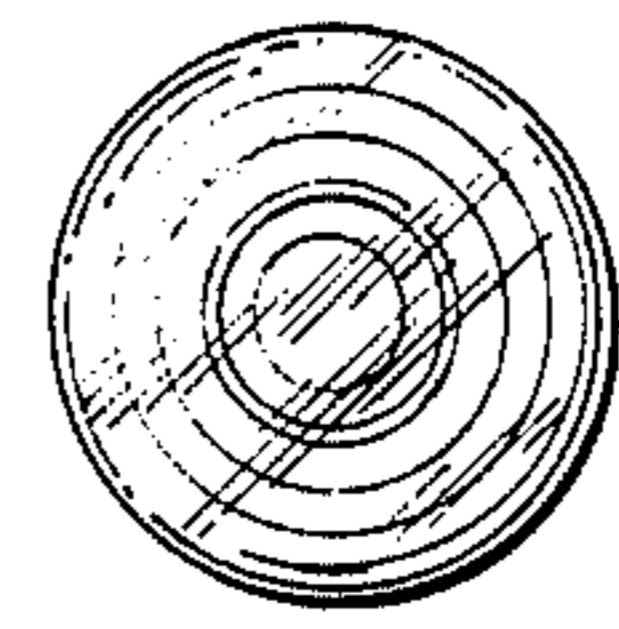

FIG. 5