

[54] STRIP FOR WATER SEALING BATH TUBS FROM DRY WALL AND WALL STUDS

[76] Inventor: Joseph M. Callahan, 26886 Parkside Dr., Hayward, Calif. 94542

[\*\*] Term: 14 Years

[21] Appl. No.: 725,936

[22] Filed: Apr. 22, 1985

[52] U.S. Cl. .... D25/119

[58] Field of Search ..... 52/288, 730, 466, 716, 52/254; D25/102, 119, 125, 136; D23/303, 304, 307

[56] References Cited

U.S. PATENT DOCUMENTS

2,094,215	9/1937	Hope	.....	52/288	X
4,189,885	2/1980	Fritz	.....	52/288	X
4,624,087	11/1986	Schneller	.....	52/288	X

Primary Examiner—A. Hugo Word  
Attorney, Agent, or Firm—Linval B. Castle

[57] CLAIM

The ornamental design for a strip for water sealing bath tubs from dry wall and wall studs, as shown and described.

DESCRIPTION

FIG. 1 is a perspective view of a strip for water sealing bath tubs from dry wall and wall studs showing my new design, the broken line showing portions of the wall and tub is for illustrative purposes only and forms no part of the claimed design;

FIG. 2 is an end view of my sealing strip;

FIG. 3 is a top plan view thereof;

FIG. 4 is a wall side elevational view thereof;

FIG. 5 is a tub side elevational view thereof; and

FIG. 6 is a bottom view thereof.

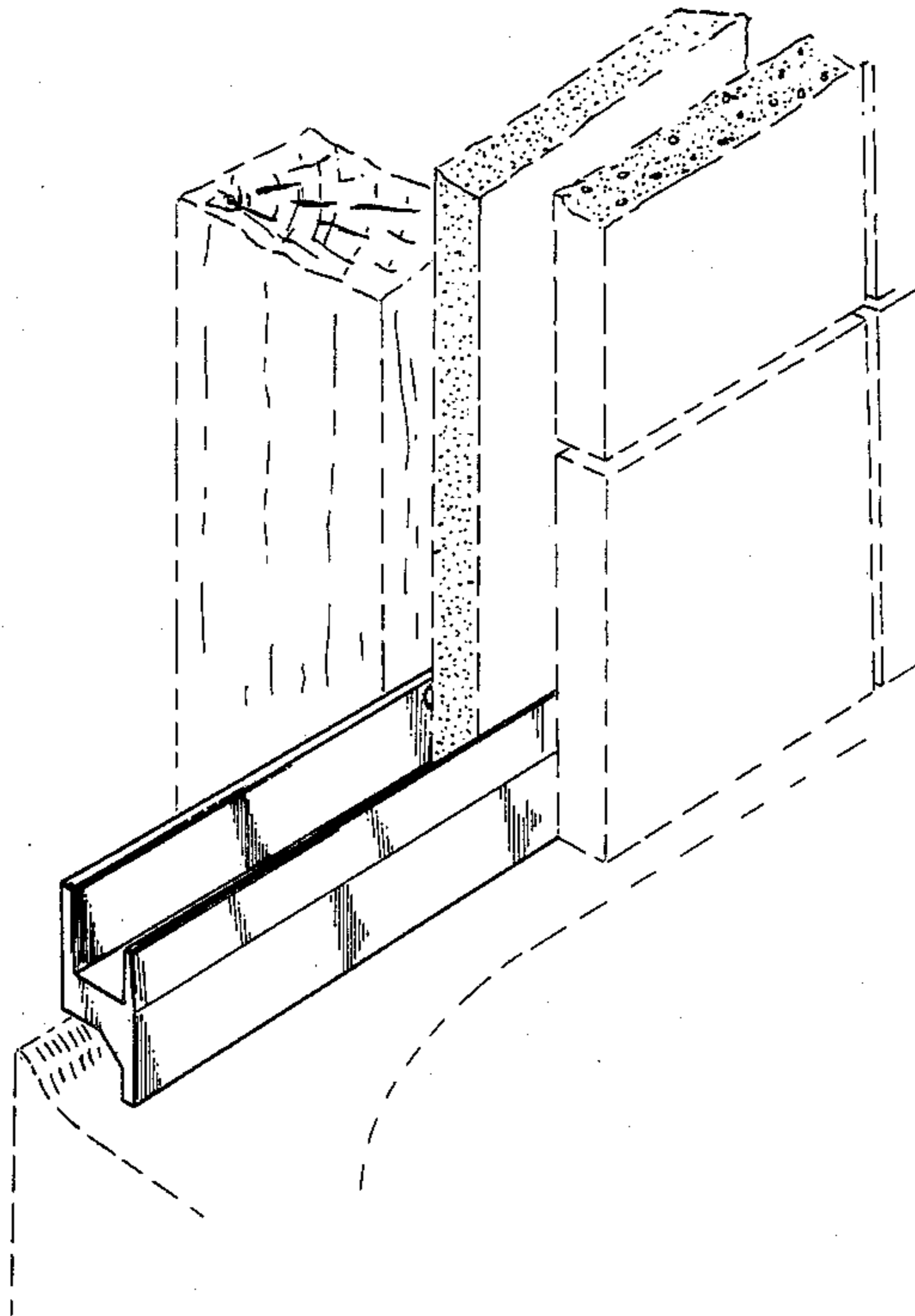

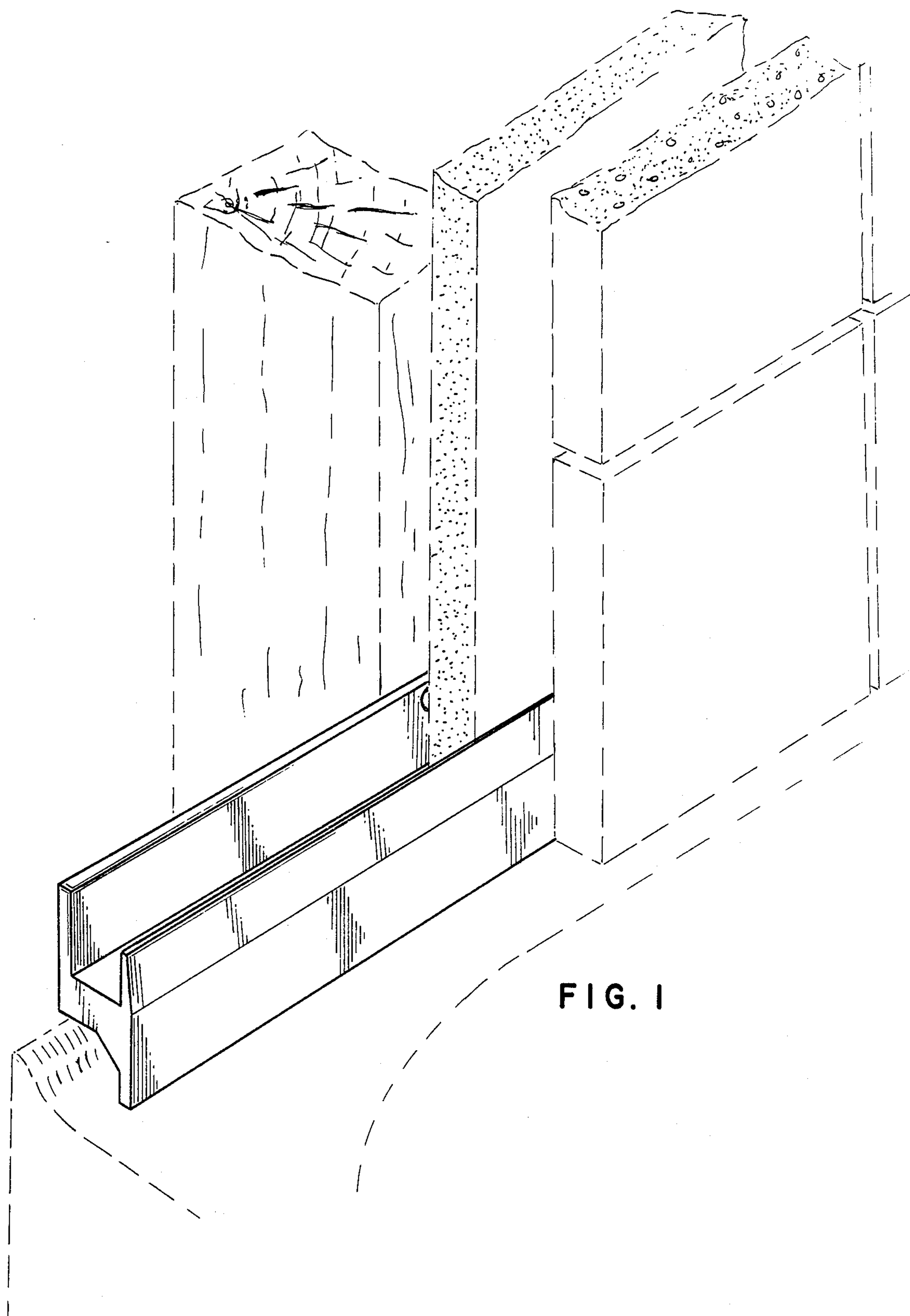

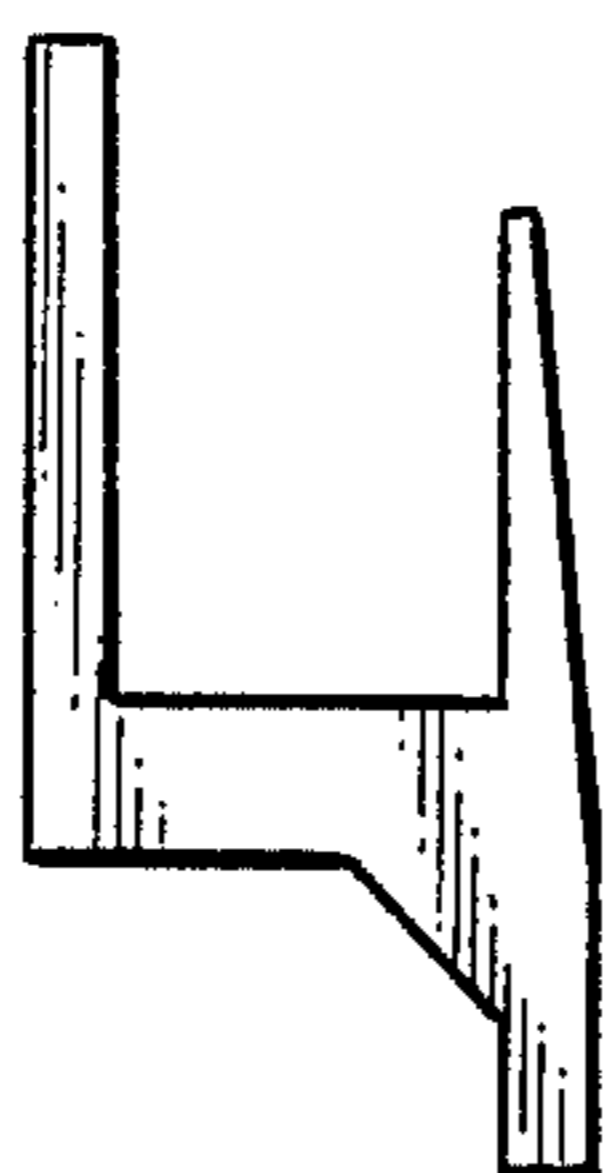

FIG. 2

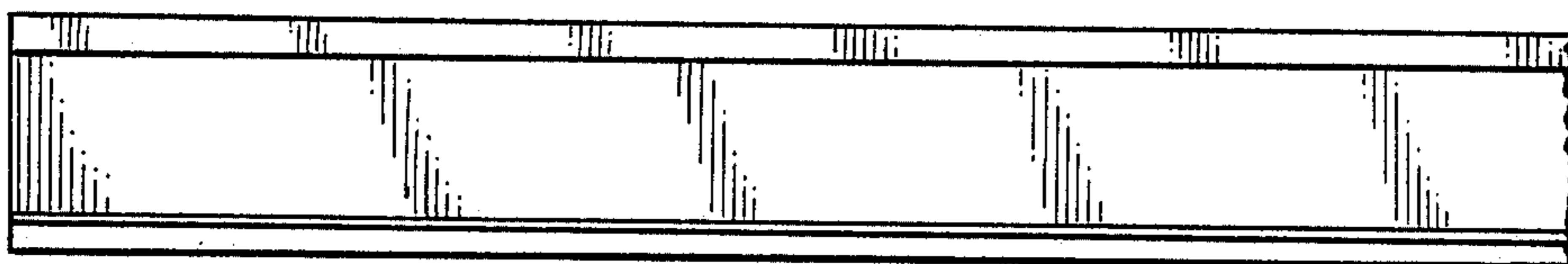

FIG. 3

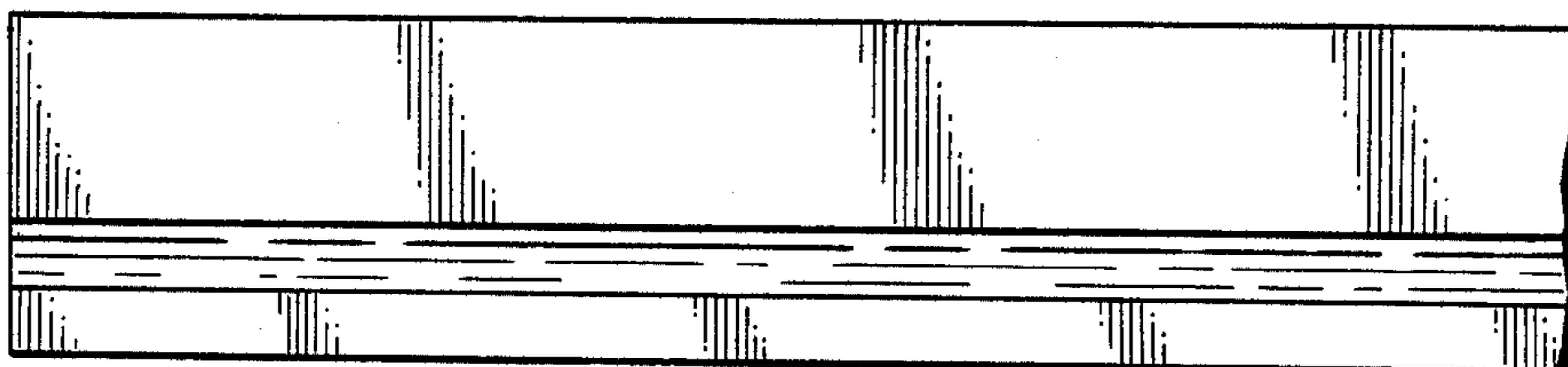

FIG. 4

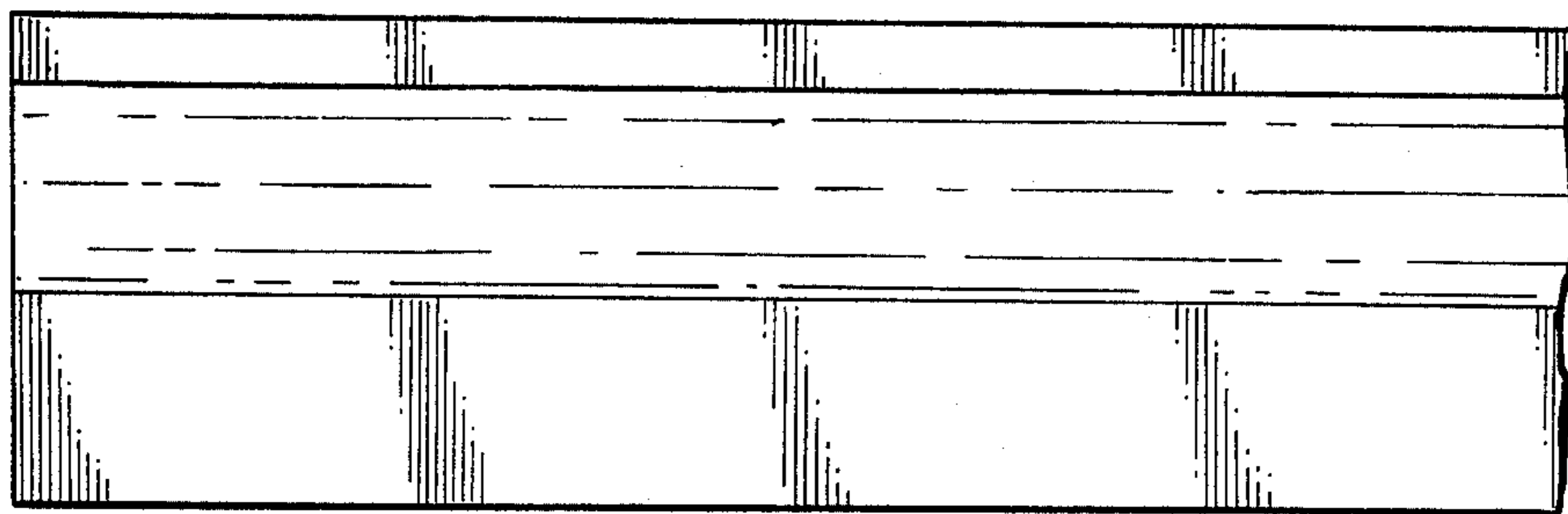

FIG. 5

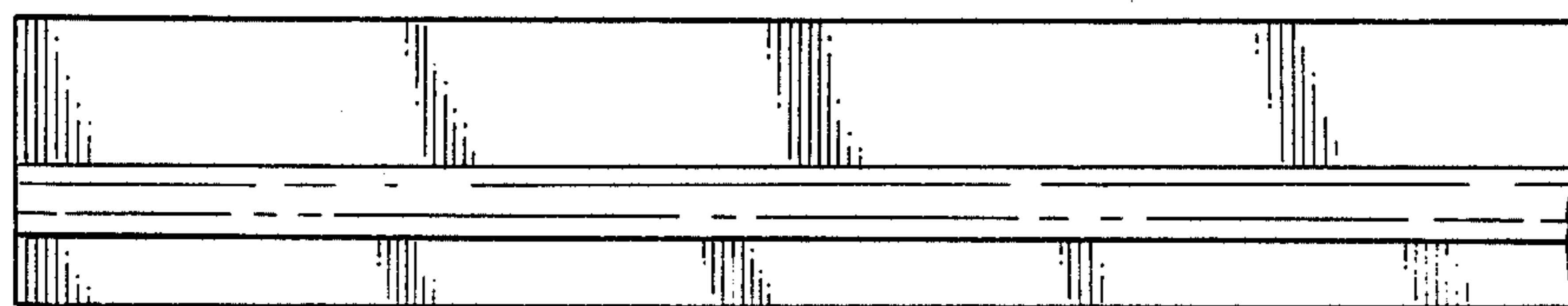

FIG. 6