

[54] CHAIR

[75] Inventor: Noel S. D. Wood, Lindfield, Australia

[73] Assignee: Sebel Furniture Ltd., Bankstown, Australia

[**] Term: 14 Years

[21] Appl. No.: 845,079

[22] Filed: Mar. 18, 1986

[30] Foreign Application Priority Data

Sep. 19, 1985 [AU] Australia 2629/85

[52] U.S. Cl. D6/380

[58] Field of Search D6/334, 364, 365, 366, D6/379, 380, 370; 297/296, 440, 445

[56] References Cited

U.S. PATENT DOCUMENTS

- D. 272,303 1/1984 Deconinck D6/380
- D. 292,149 10/1987 Monesi D6/380
- D. 292,951 12/1987 Lamb D6/380 X
- 3,111,344 11/1963 Hoven et al. D6/380 X
- 4,549,764 10/1985 Haedo 297/296

Primary Examiner—Bruce W. Dunkins
Attorney, Agent, or Firm—Townsend & Townsend

[57] CLAIM

The ornamental design for a chair, as shown and described.

DESCRIPTION

FIG. 1 is a front perspective view of a chair showing my new design;
 FIG. 2 is a bottom plan view;
 FIG. 3 is a top plan view;
 FIG. 4 is a front elevational view;
 FIG. 5 is a rear elevational view;
 FIG. 6 is a left side elevational view;
 FIG. 7 is a right side elevational view thereof;
 FIG. 8 is a front perspective view of a chair showing a second embodiment of my design;
 FIG. 9 is a bottom plan view;
 FIG. 10 is a top plan view;
 FIG. 11 is a front elevational view;
 FIG. 12 is a rear elevational view;
 FIG. 13 is a left side elevational view; and,
 FIG. 14 is a right side elevational view thereof.

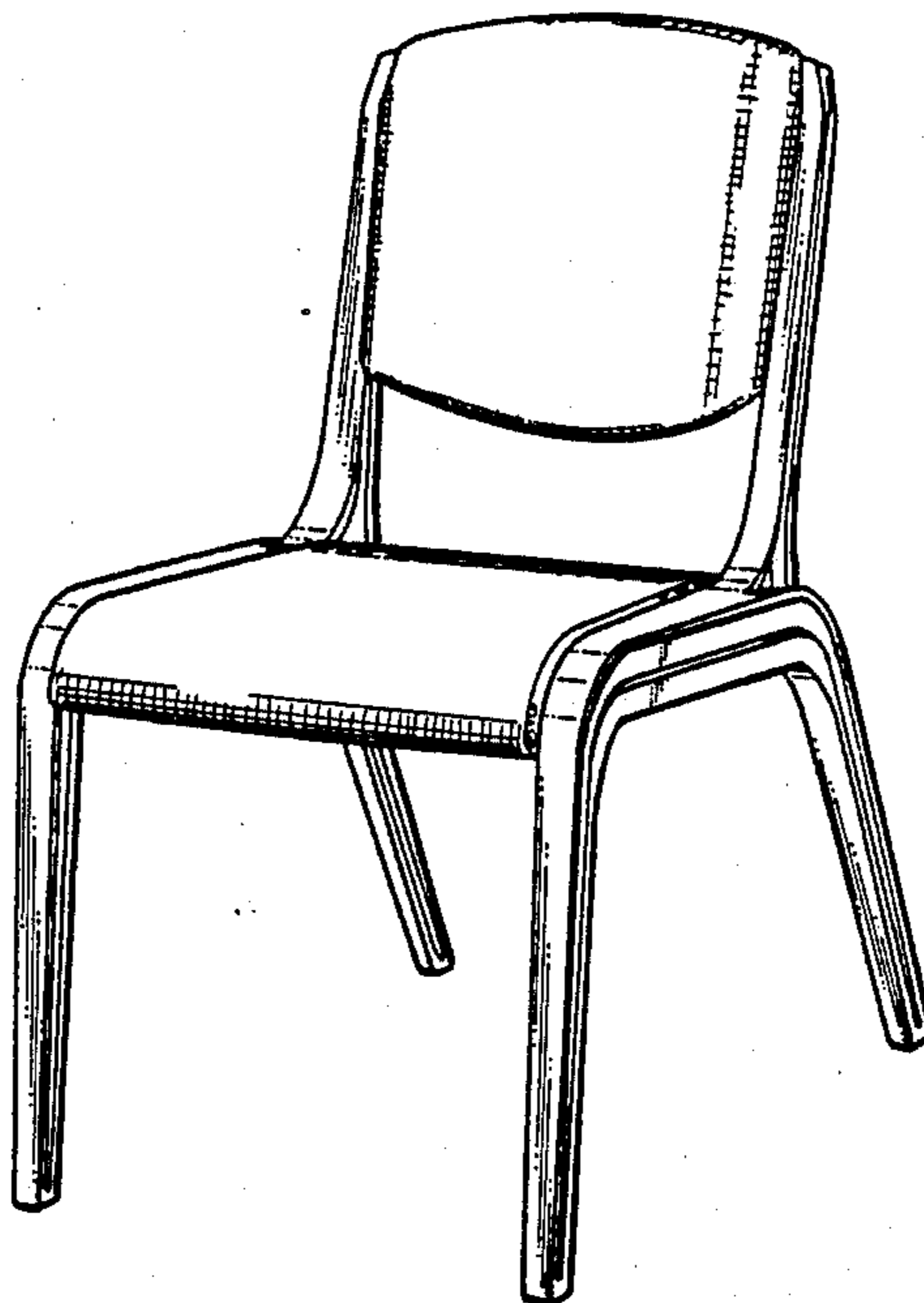

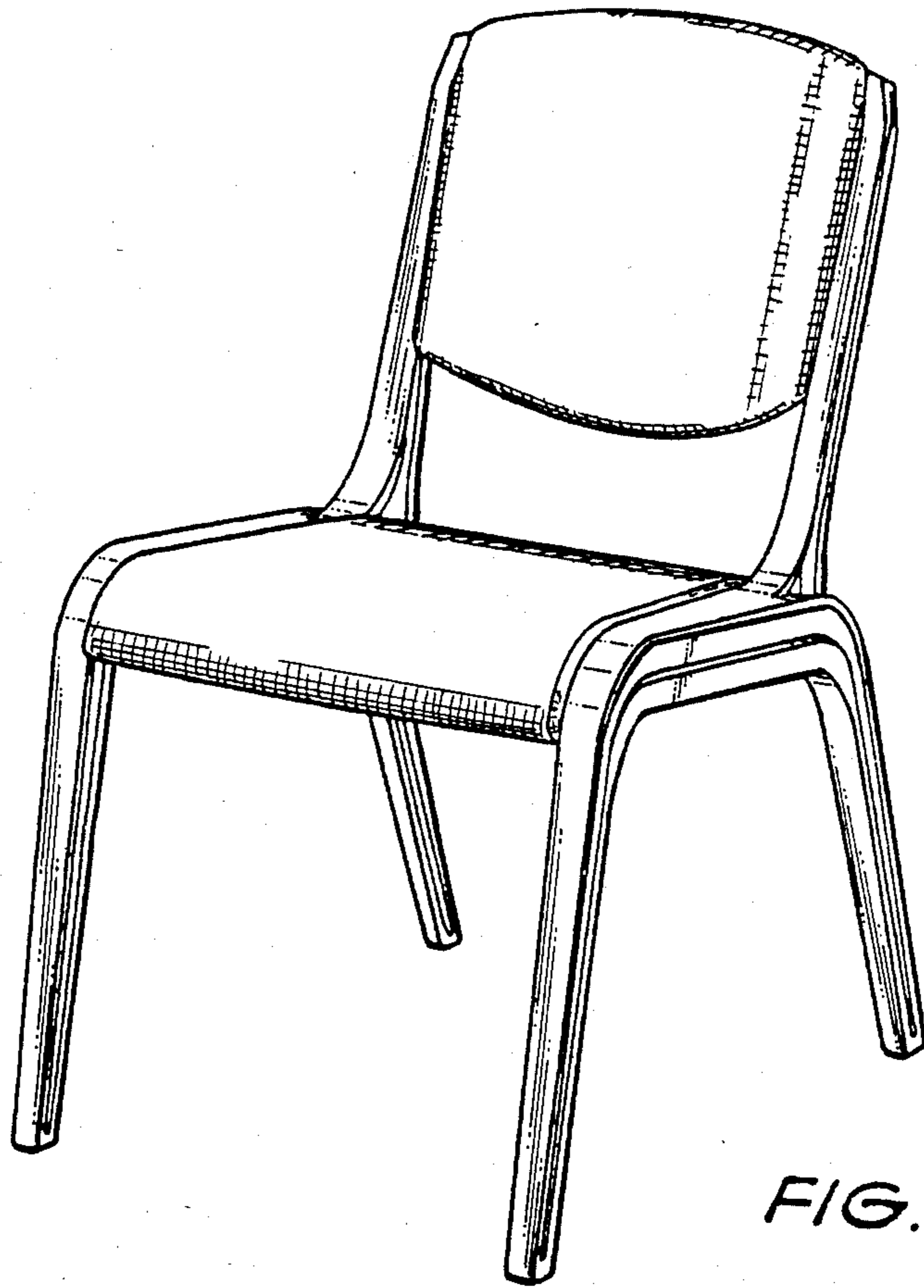

FIG. 1

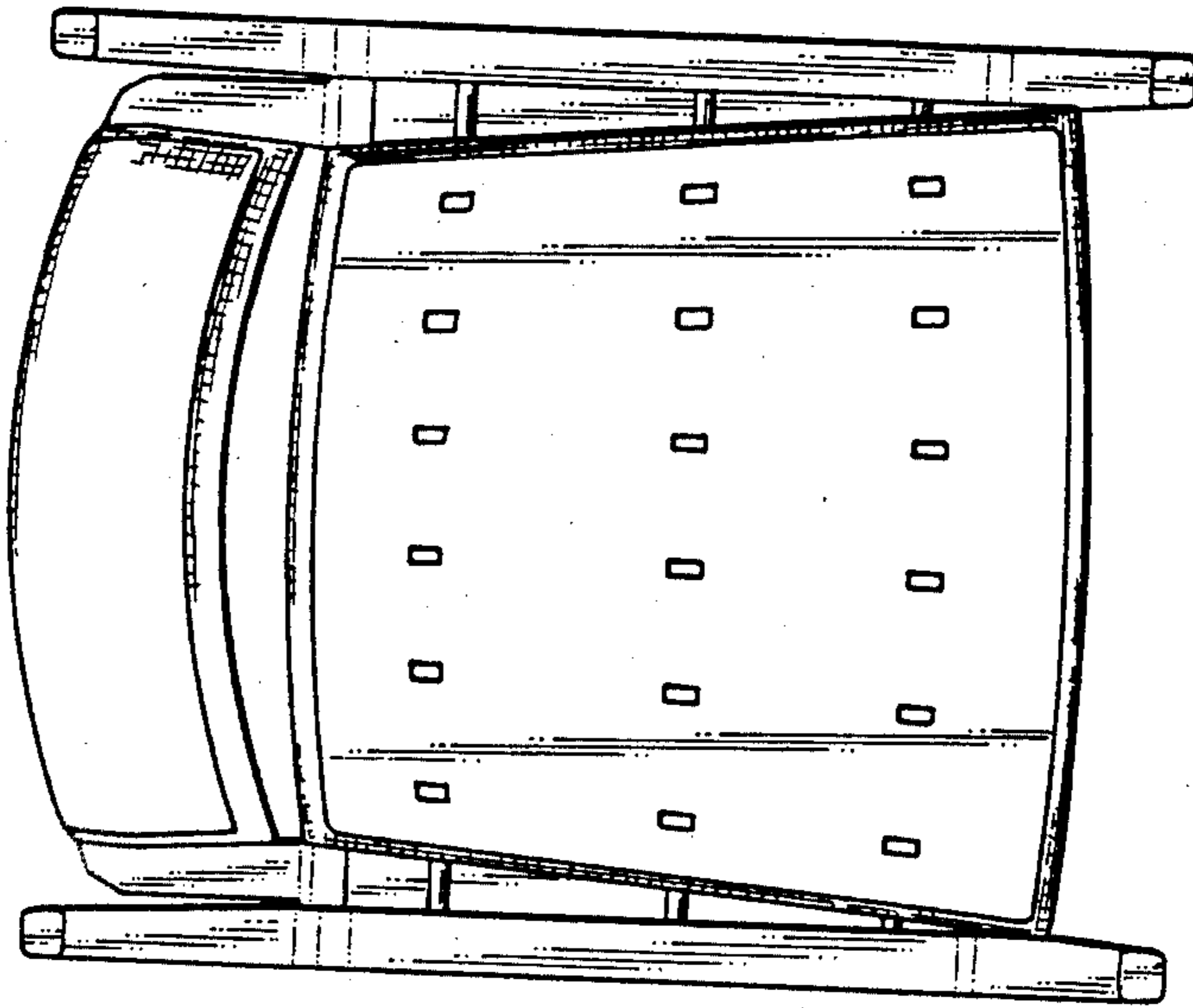

FIG. 2

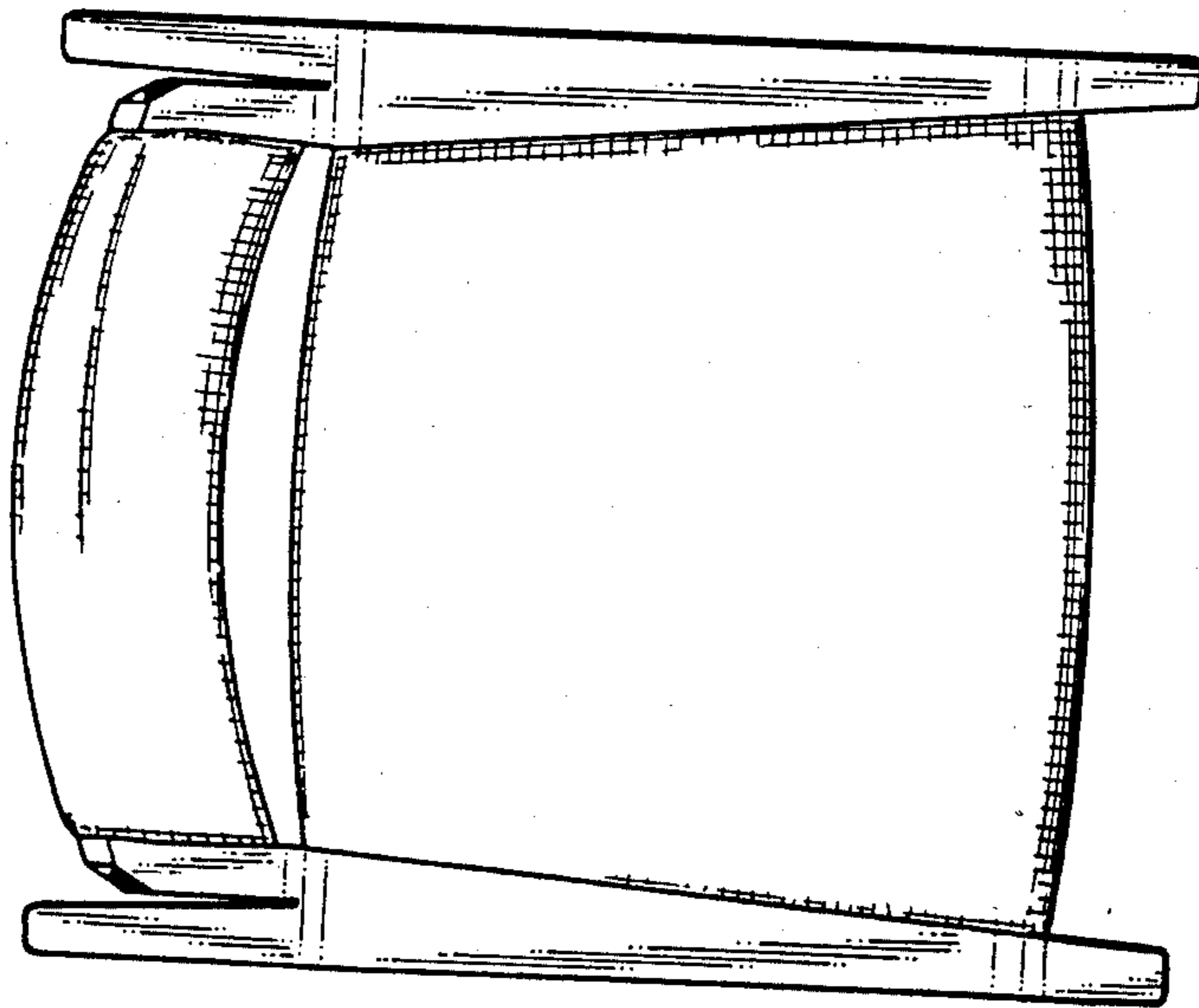

FIG. 3

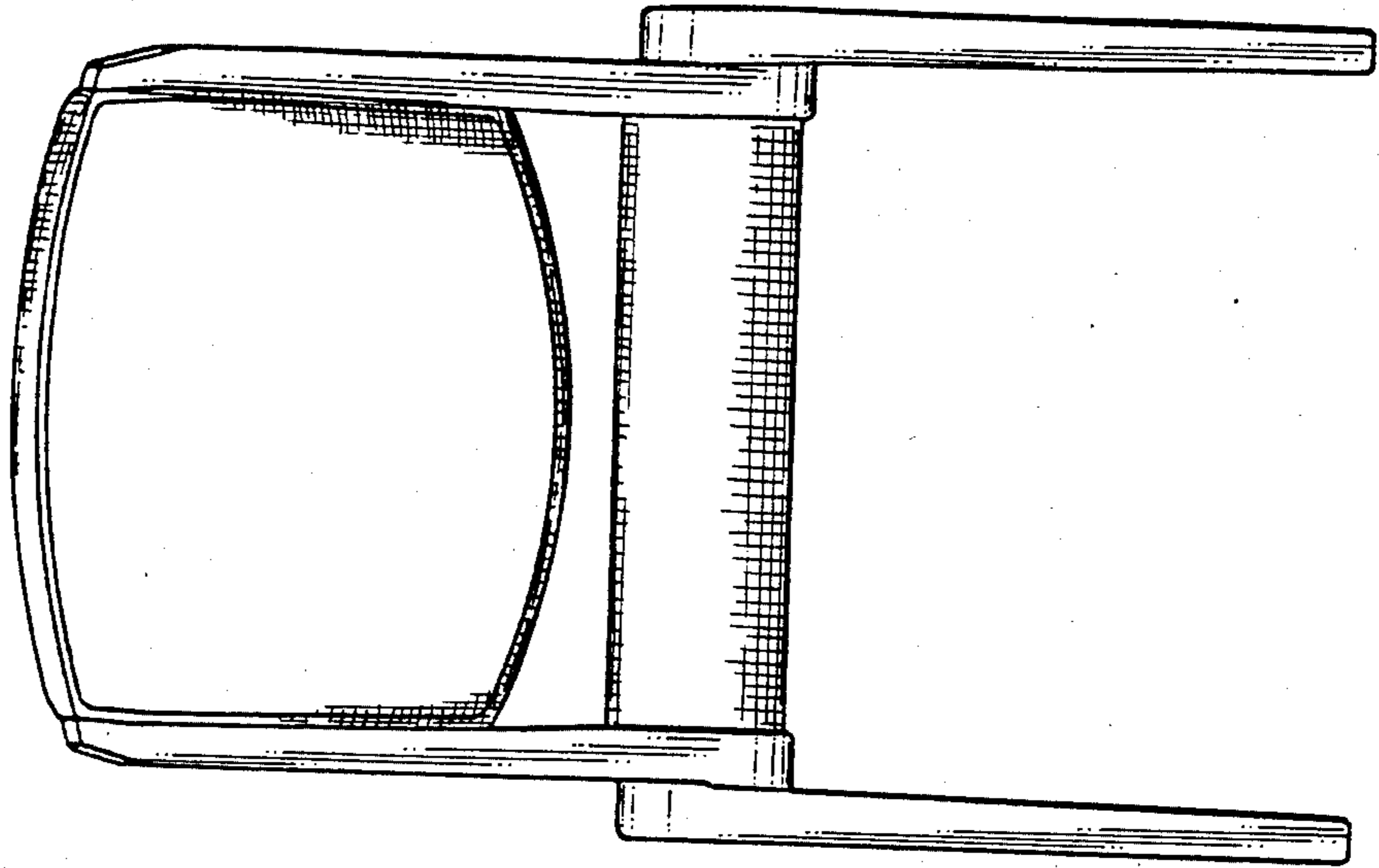

FIG. 5

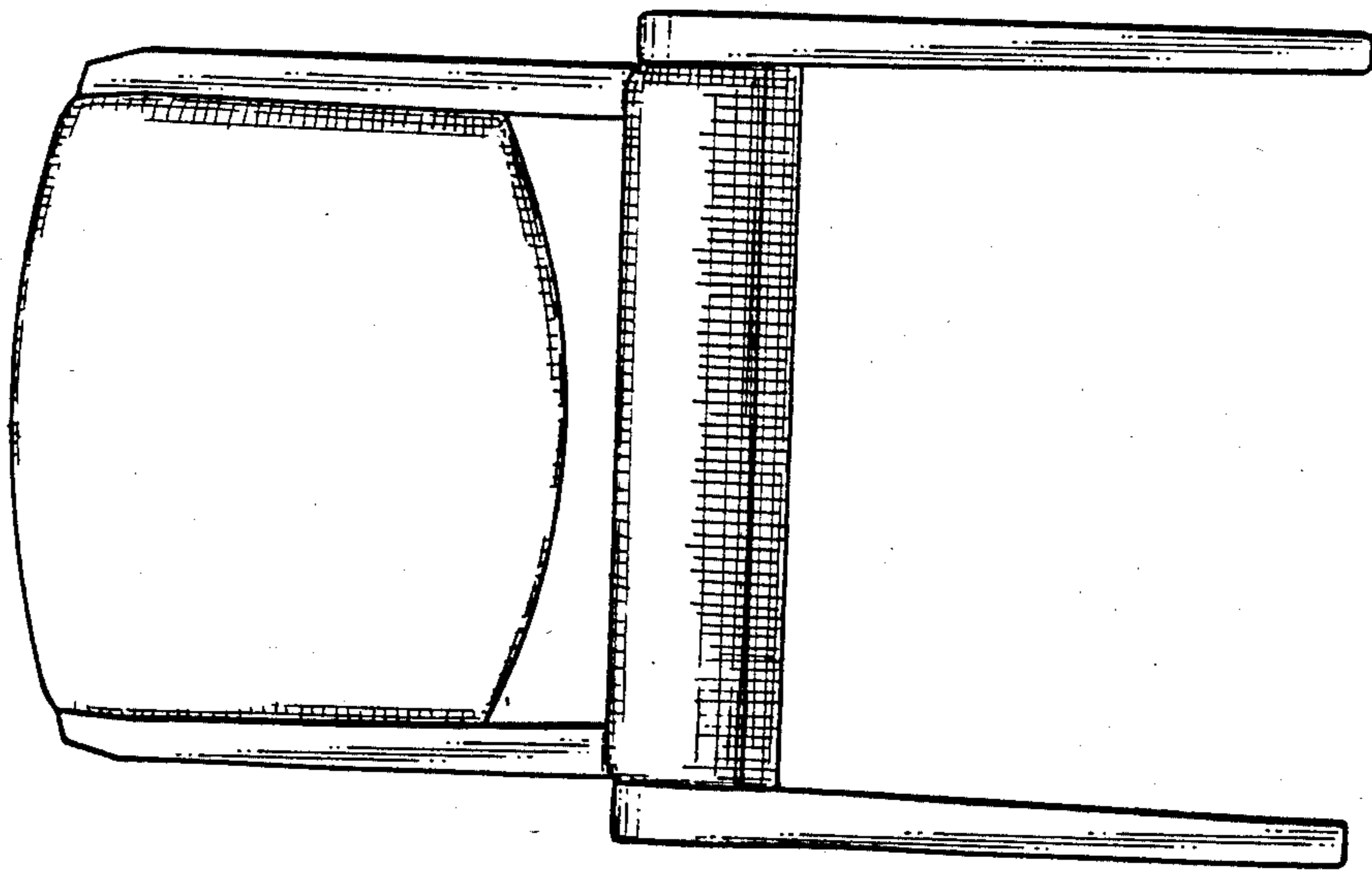

FIG. 4

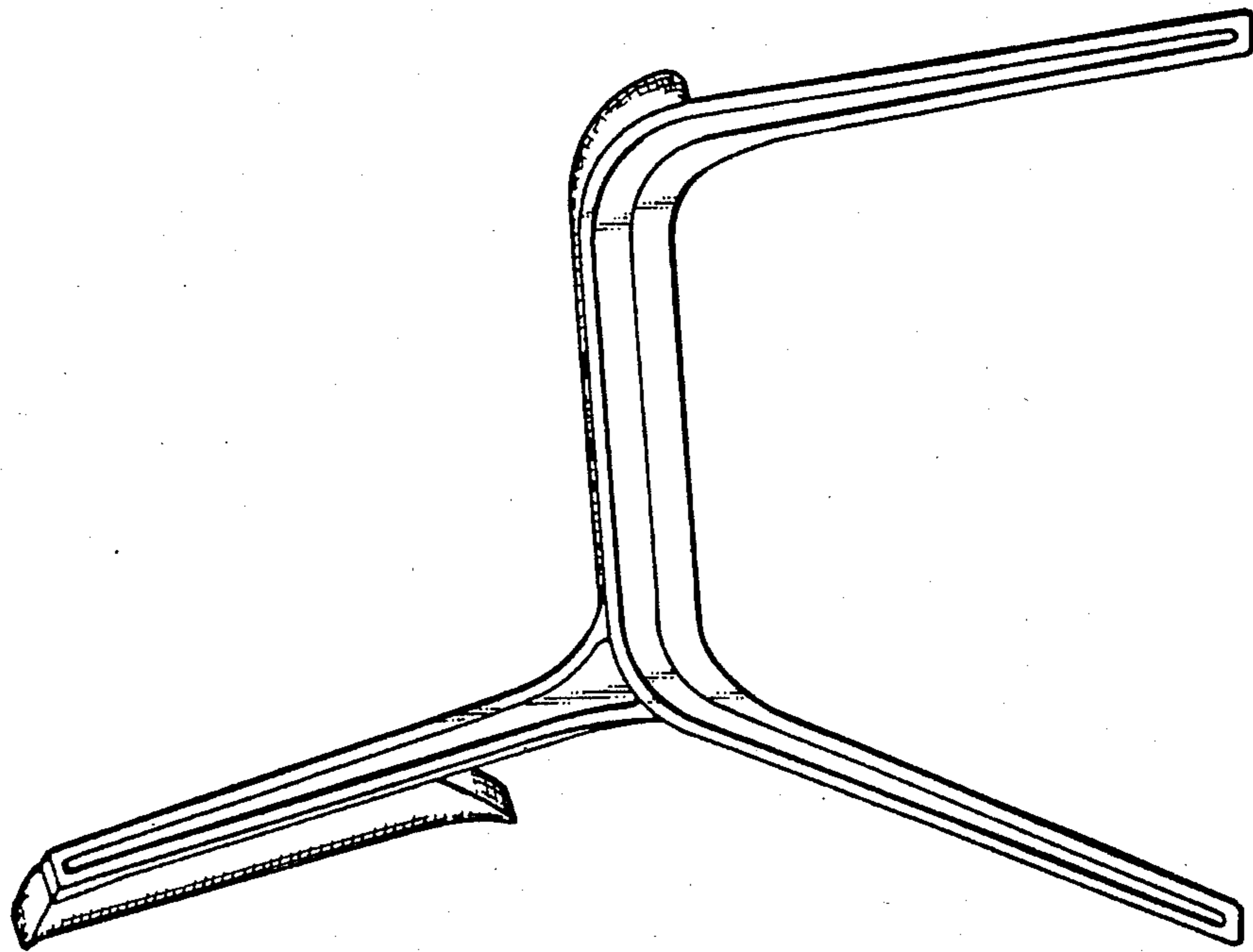

FIG. 7

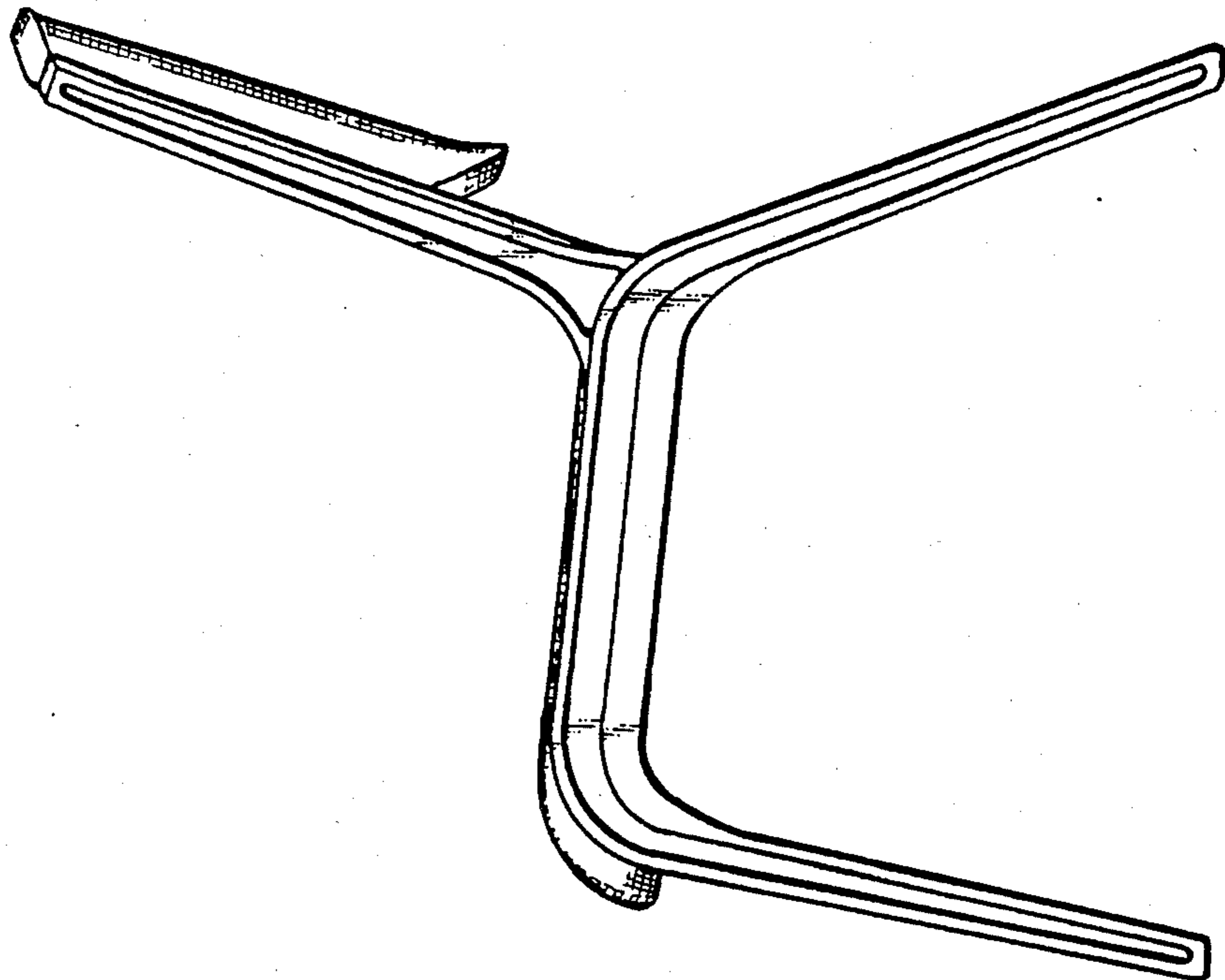

FIG. 6

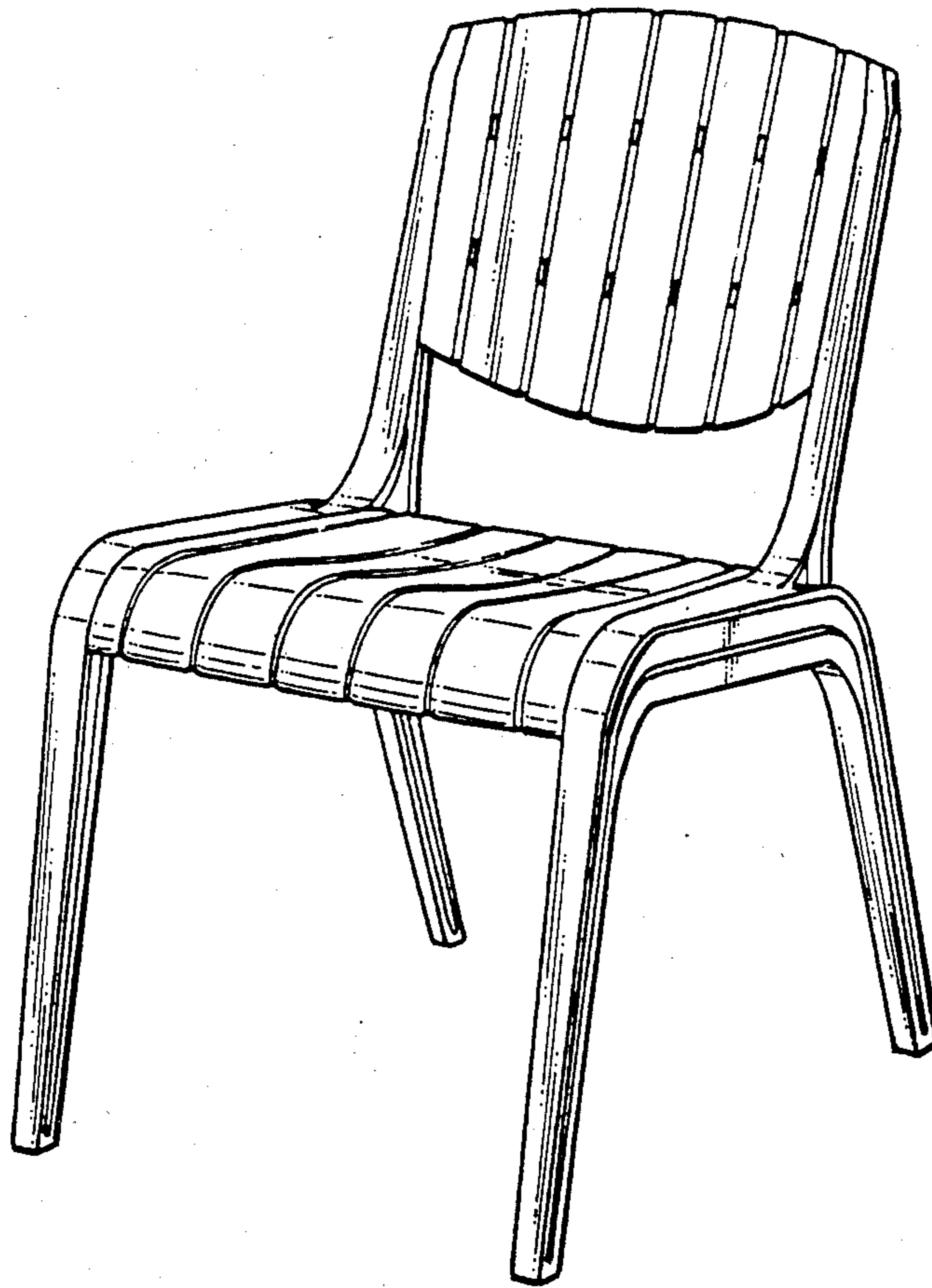

FIG. 8.

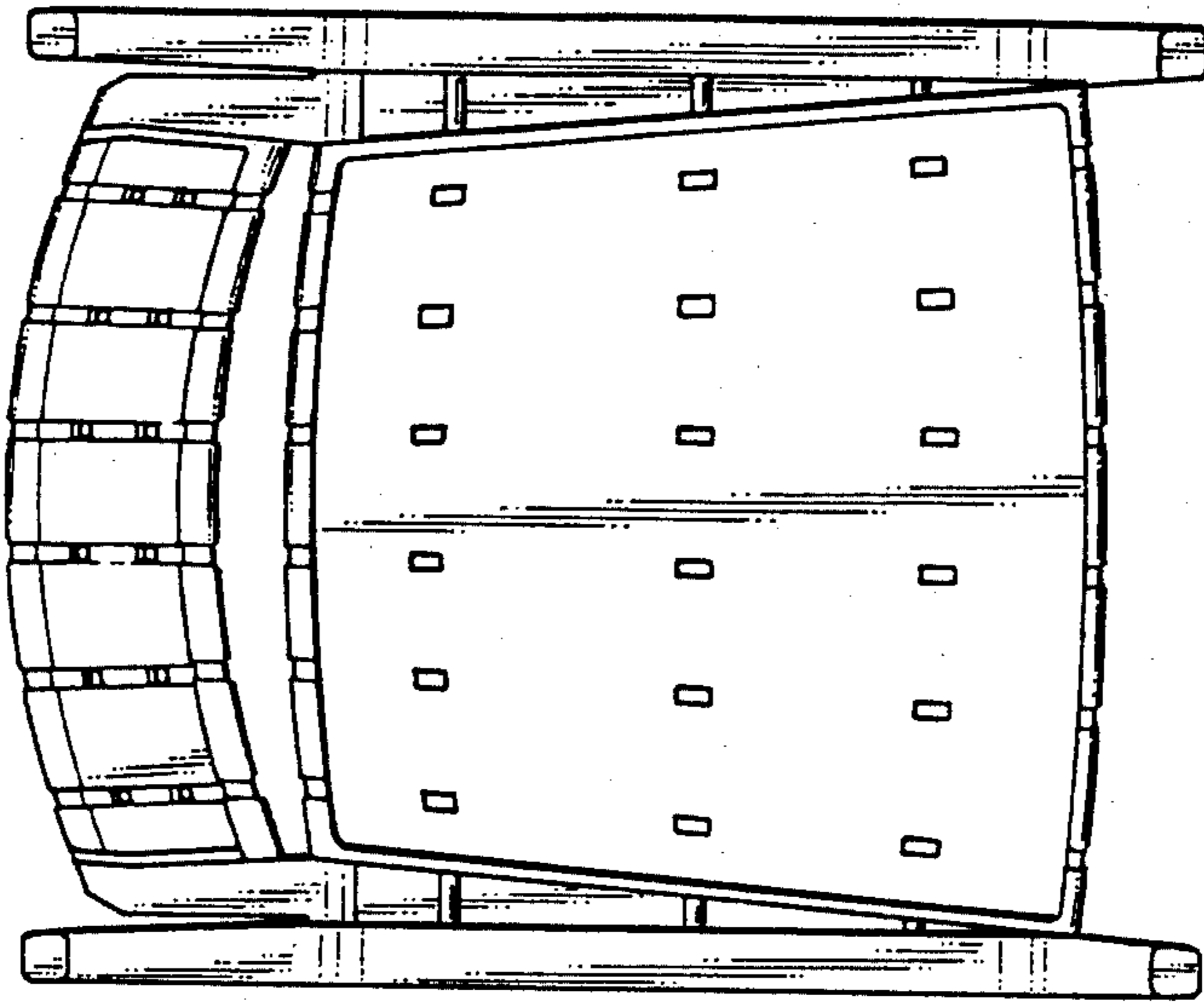

FIG. 9.

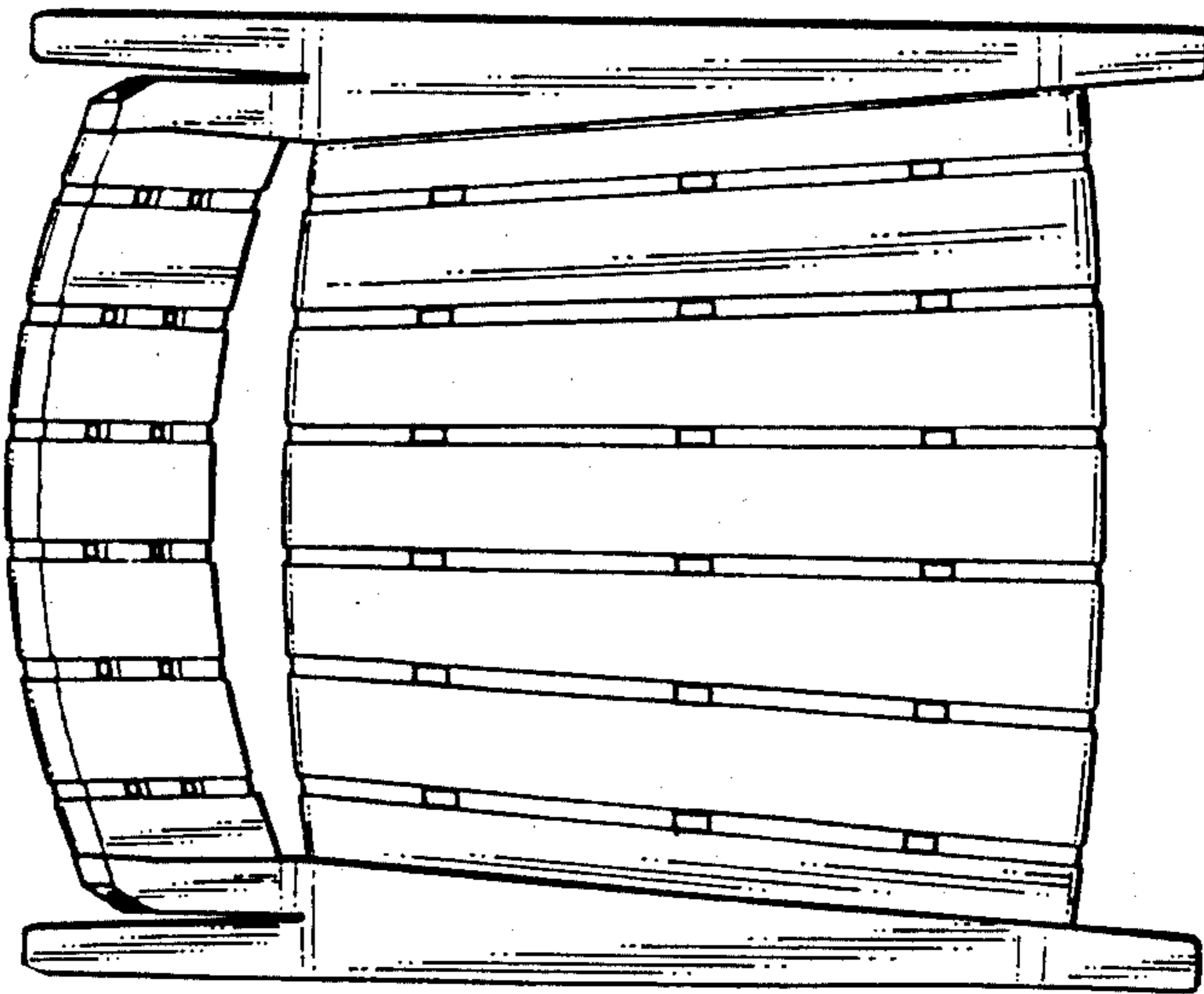

FIG. 10.

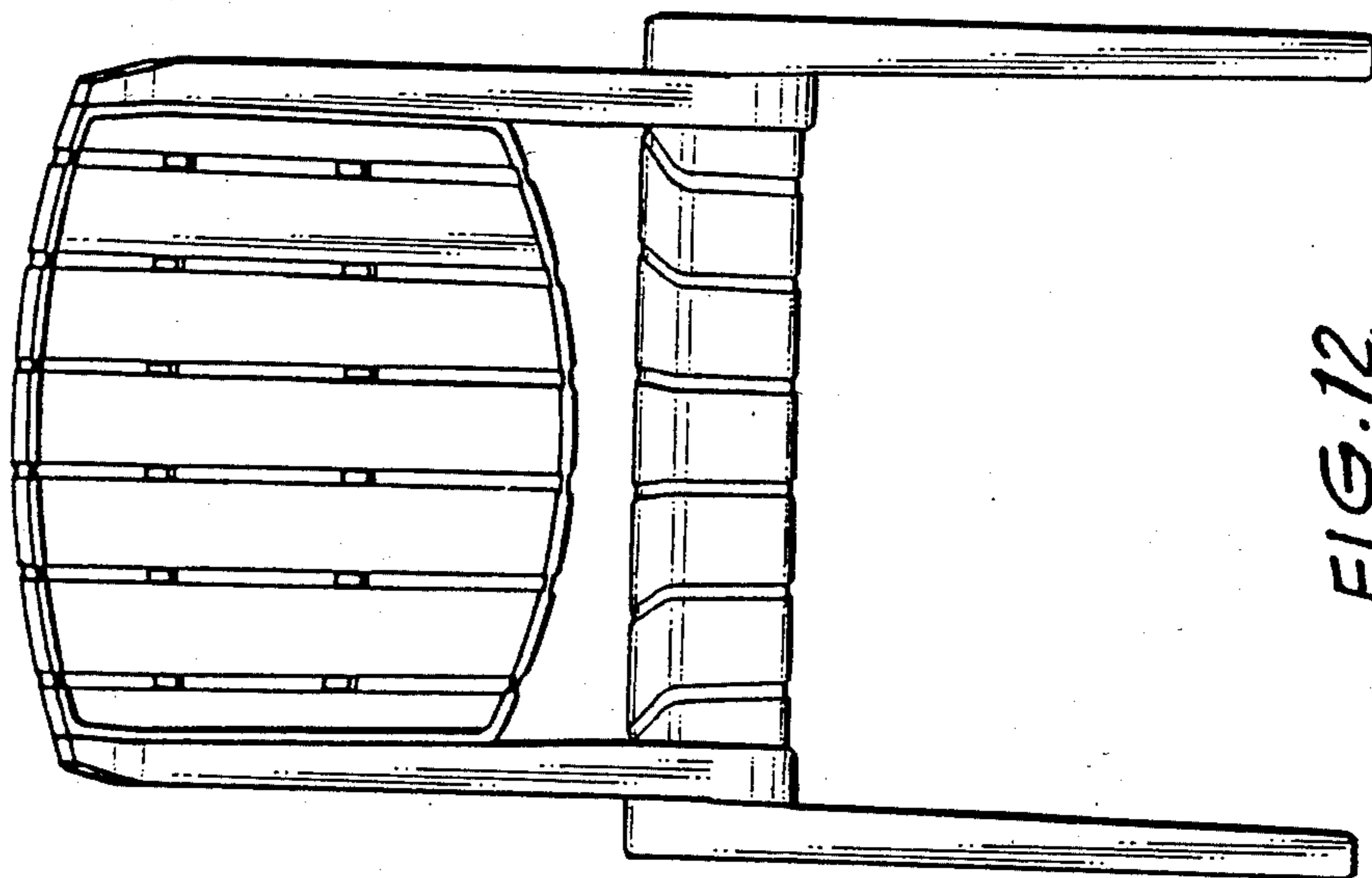

FIG. 12.

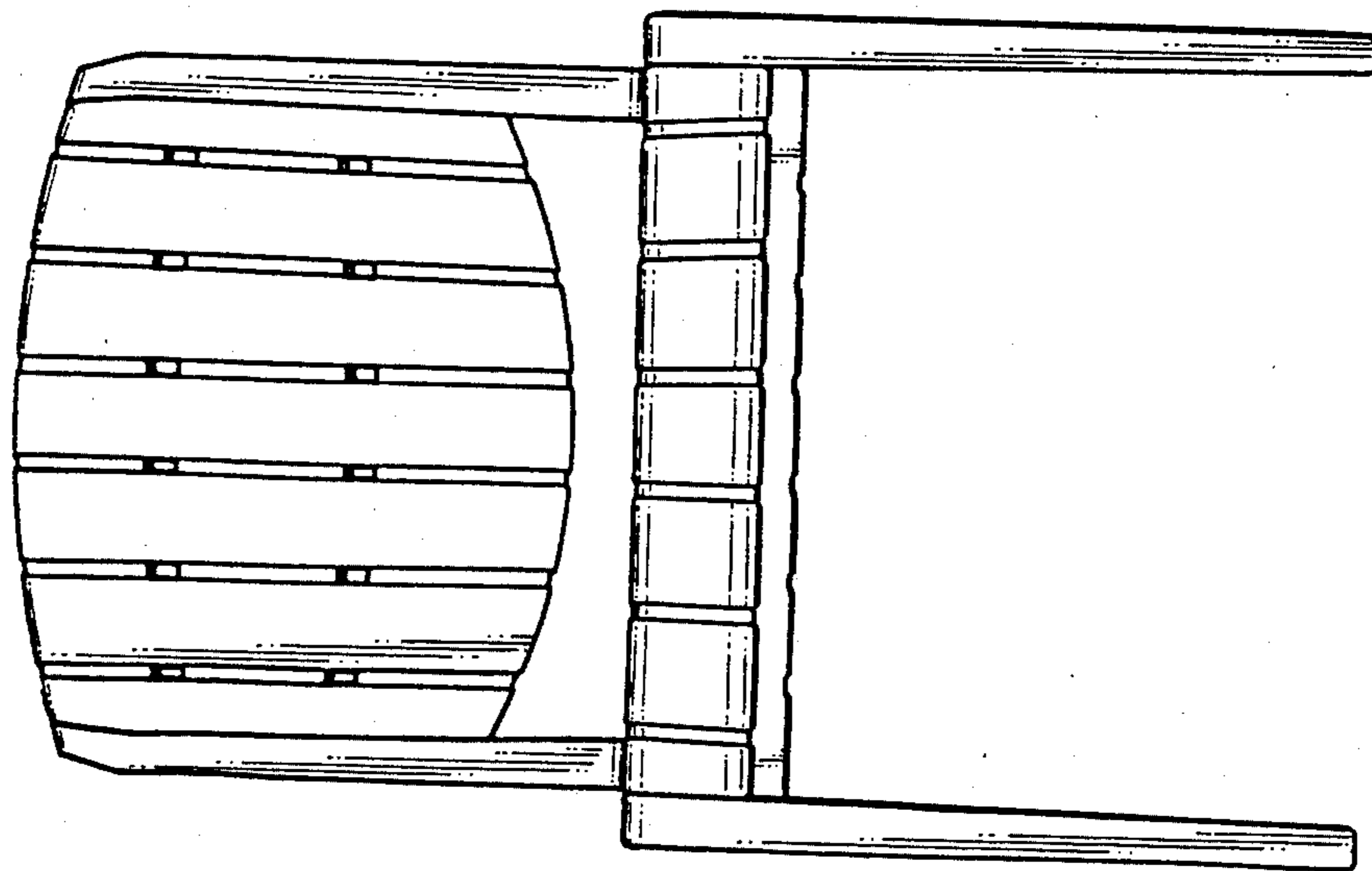

FIG. 11.

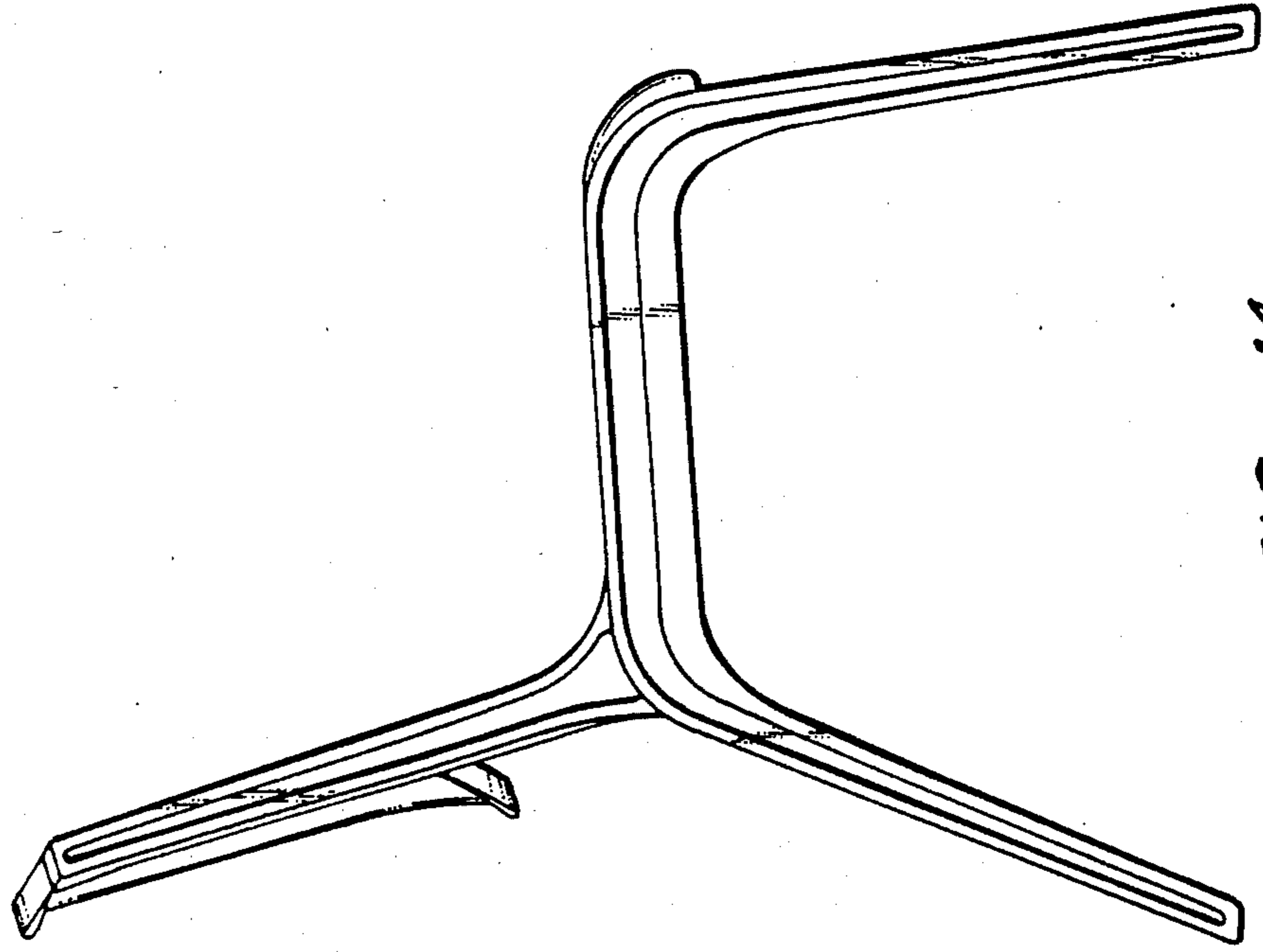

FIG. 14.

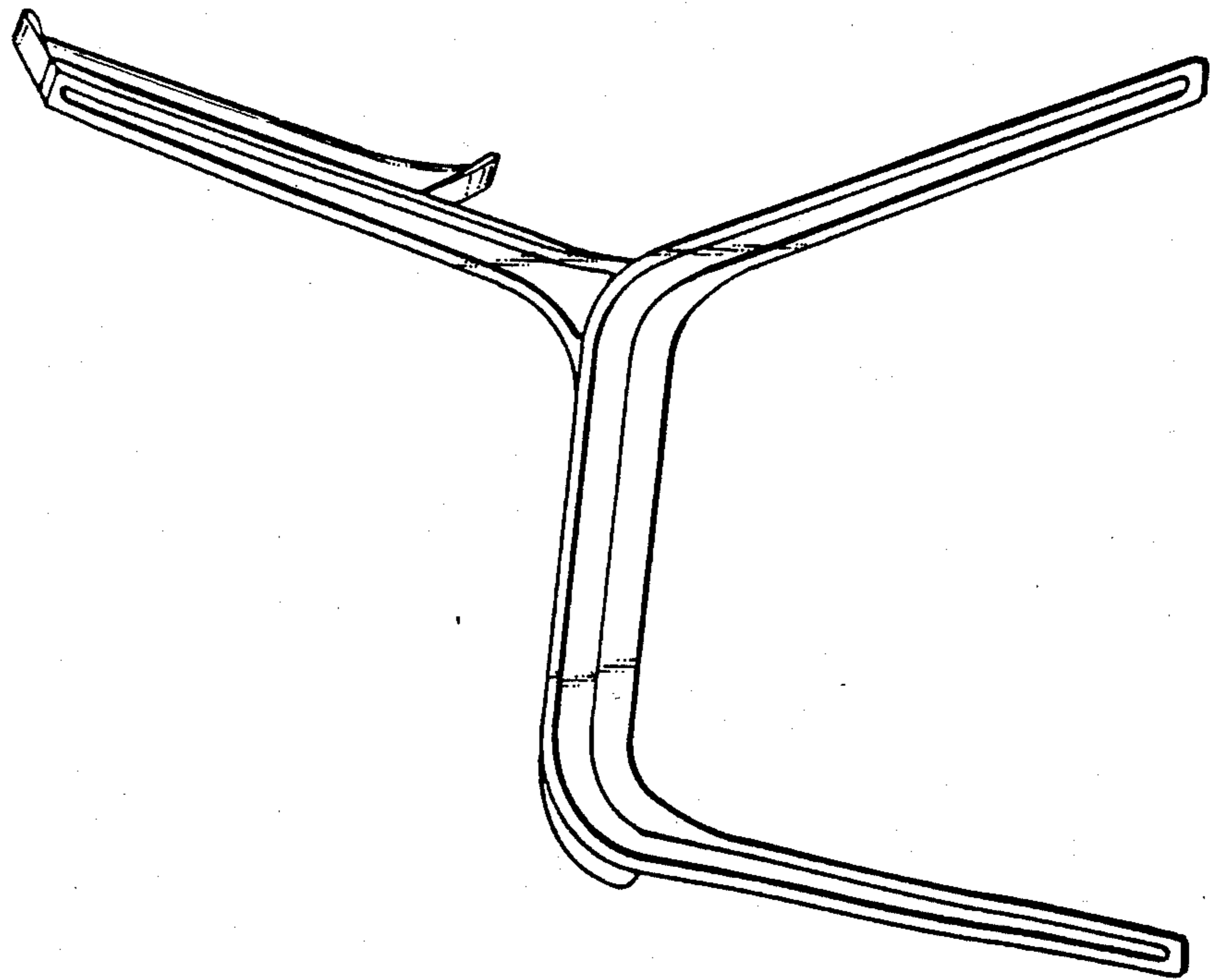

FIG. 13.