

[54] TOY SAUCEPAN

[75] Inventor: Craig J. McElhaney, East Aurora, N.Y.

[73] Assignee: The Quaker Oats Company, Chicago, Ill.

[\*\*] Term: 14 Years

[21] Appl. No.: 919,486

[22] Filed: Oct. 15, 1986

[52] U.S. Cl. .... D21/109; D21/122

[58] Field of Search ..... D21/122, 109, 59; D7/334, 354, 355, 314, 361; 446/71, 73, 479, 481, 491

[56] References Cited

U.S. PATENT DOCUMENTS

- D. 39,694 12/1908 Swan ..... D7/355
- D. 230,041 1/1974 Saito ..... D21/122
- D. 248,363 7/1978 Rinaldi ..... D7/354

D. 276,398 11/1984 Conti et al. .... D7/354

OTHER PUBLICATIONS

Sears Wish Book, 1986, p. 408, Item #6, toy pan.

Primary Examiner—Charles A. Rademaker  
Attorney, Agent, or Firm—Cumpston & Shaw

[57] CLAIM

The ornamental design for a toy saucepan, as shown and described.

DESCRIPTION

FIG. 1 is a left-side elevational view of a toy saucepan showing my new design, the right-side being substantially a mirror image thereof;  
 FIG. 2 is a front elevational view thereof;  
 FIG. 3 is a top plan view thereof;  
 FIG. 4 is a rear elevational view thereof;  
 FIG. 5 is a bottom plan view thereof; and  
 FIG. 6 is a section view thereof taken along the line 6—6 of FIG. 2.

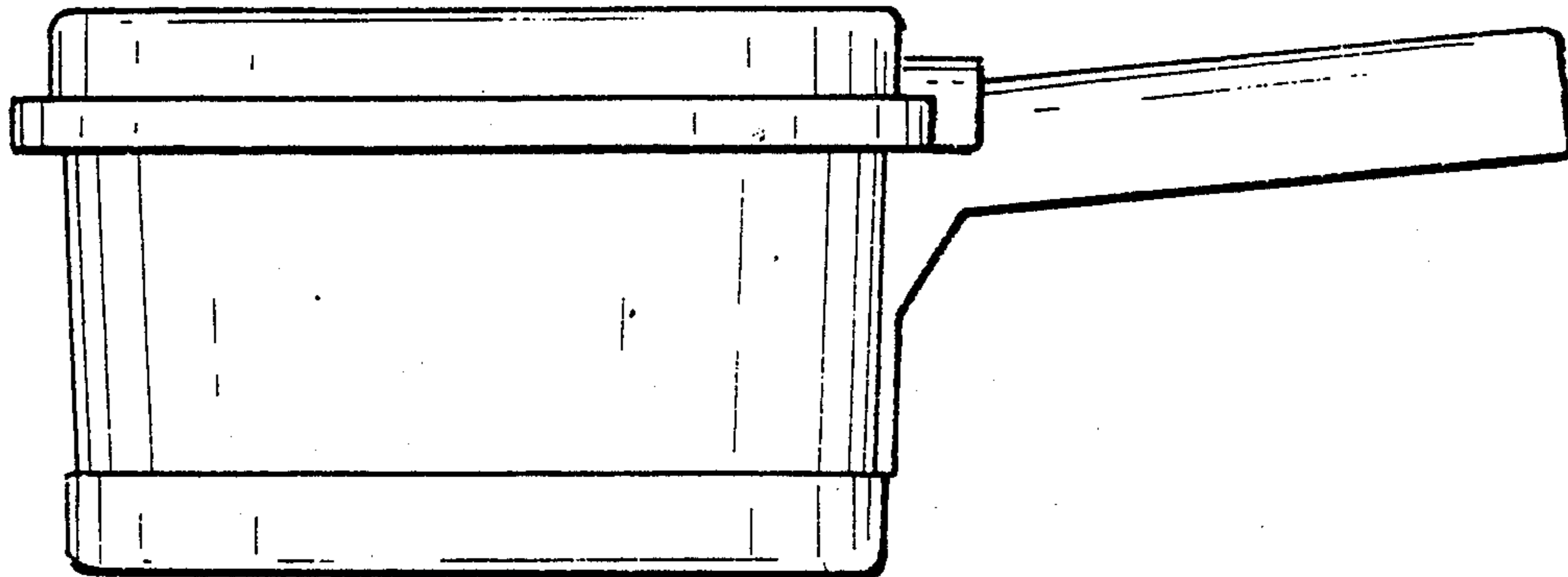

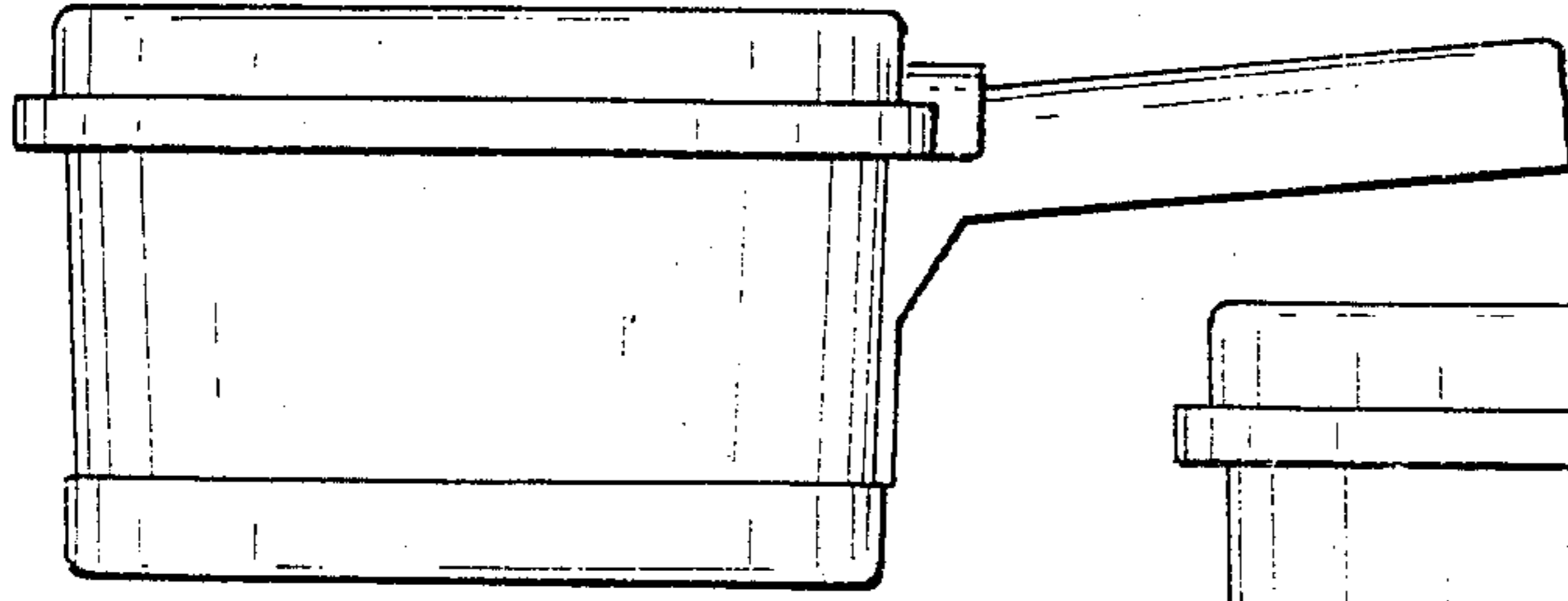

FIG. 1

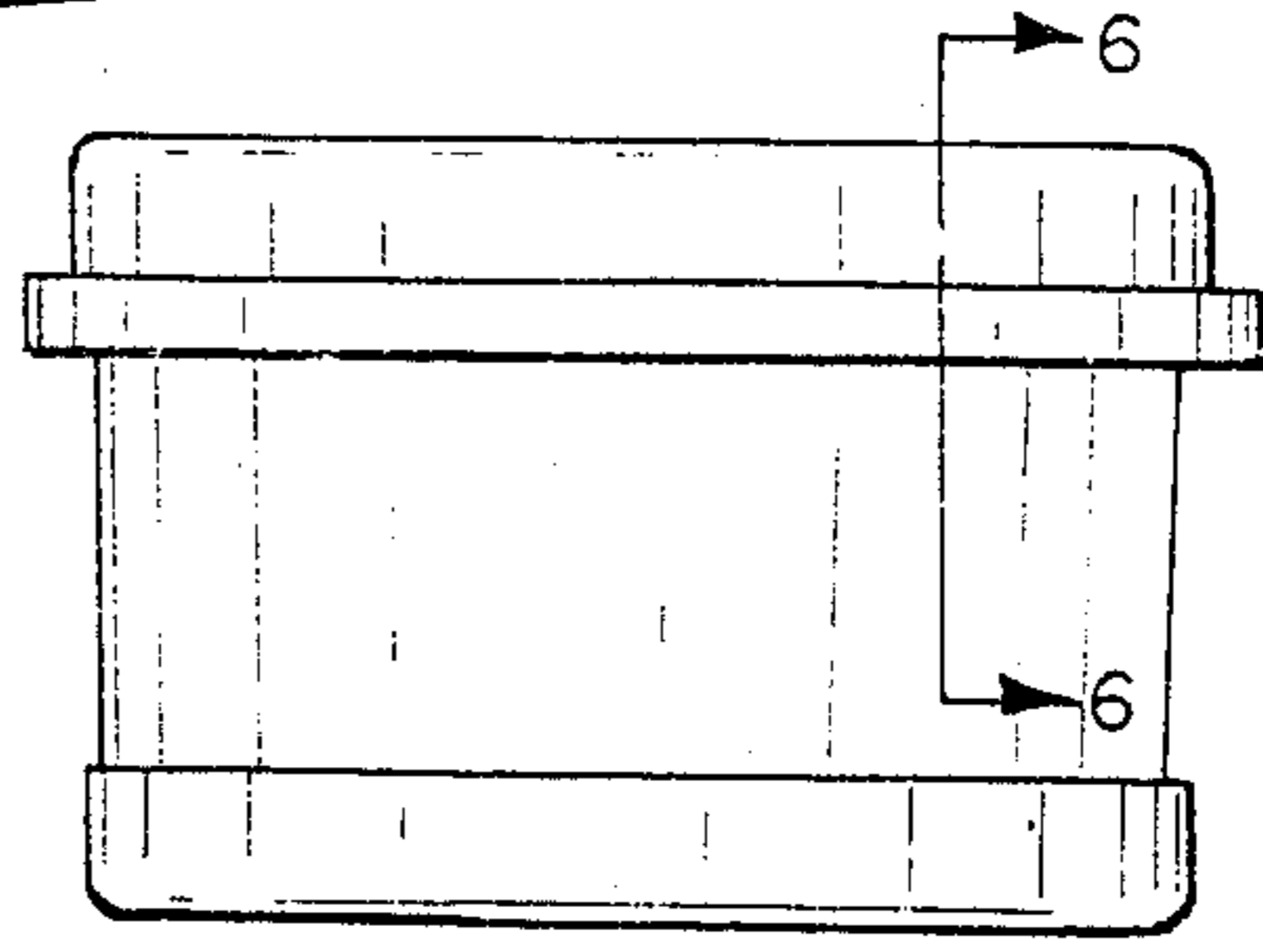

FIG. 2

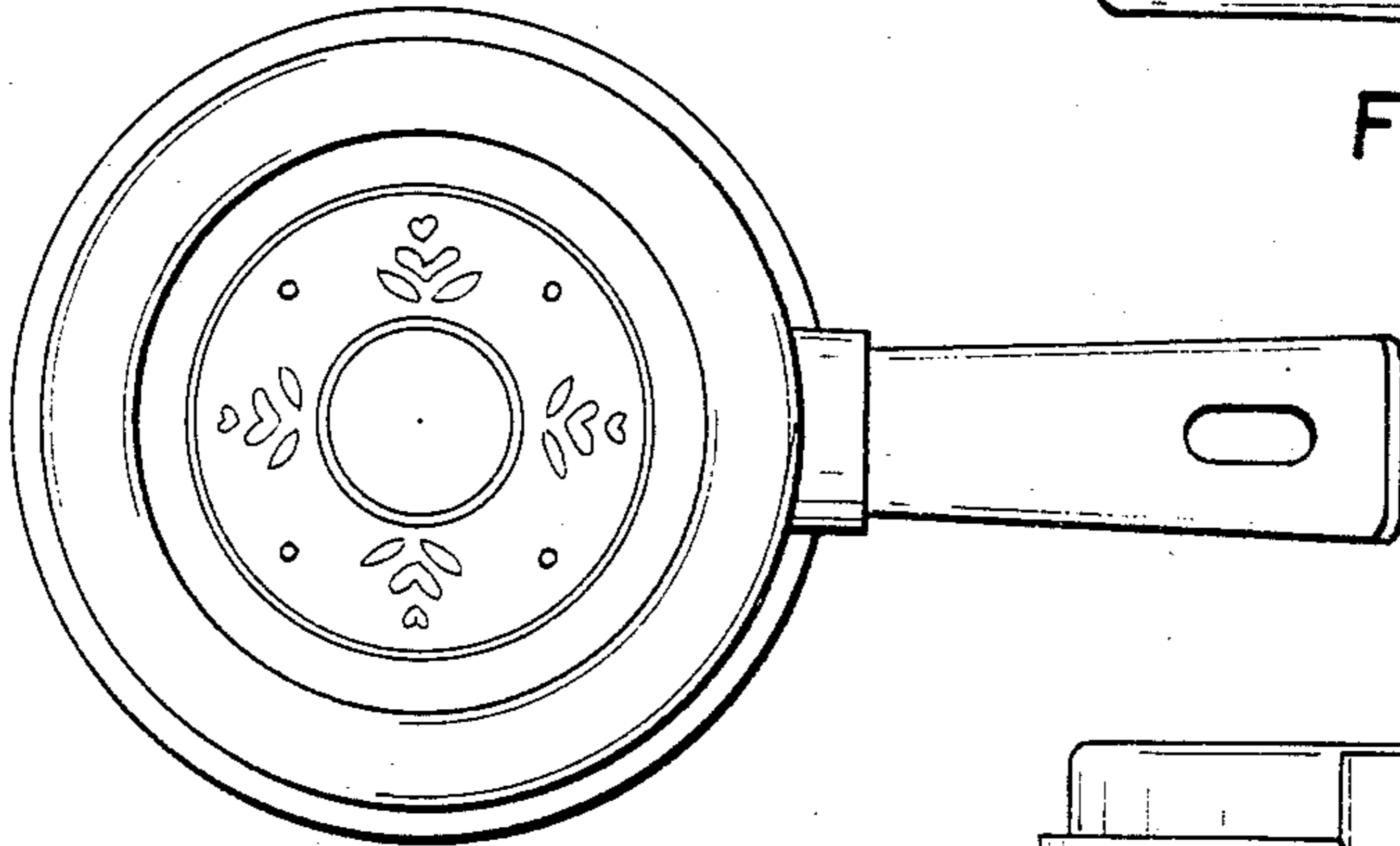

FIG. 3

FIG. 4

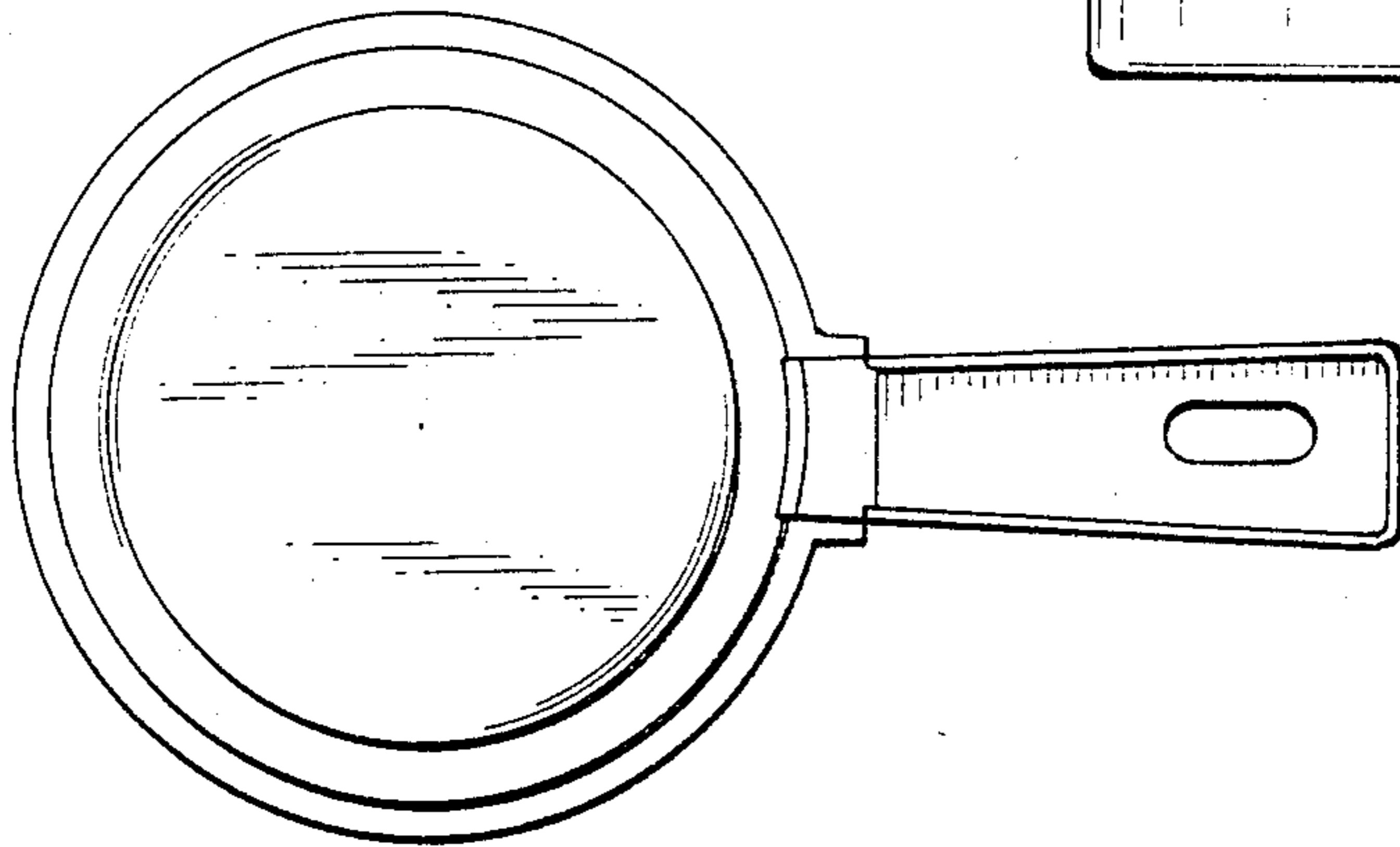
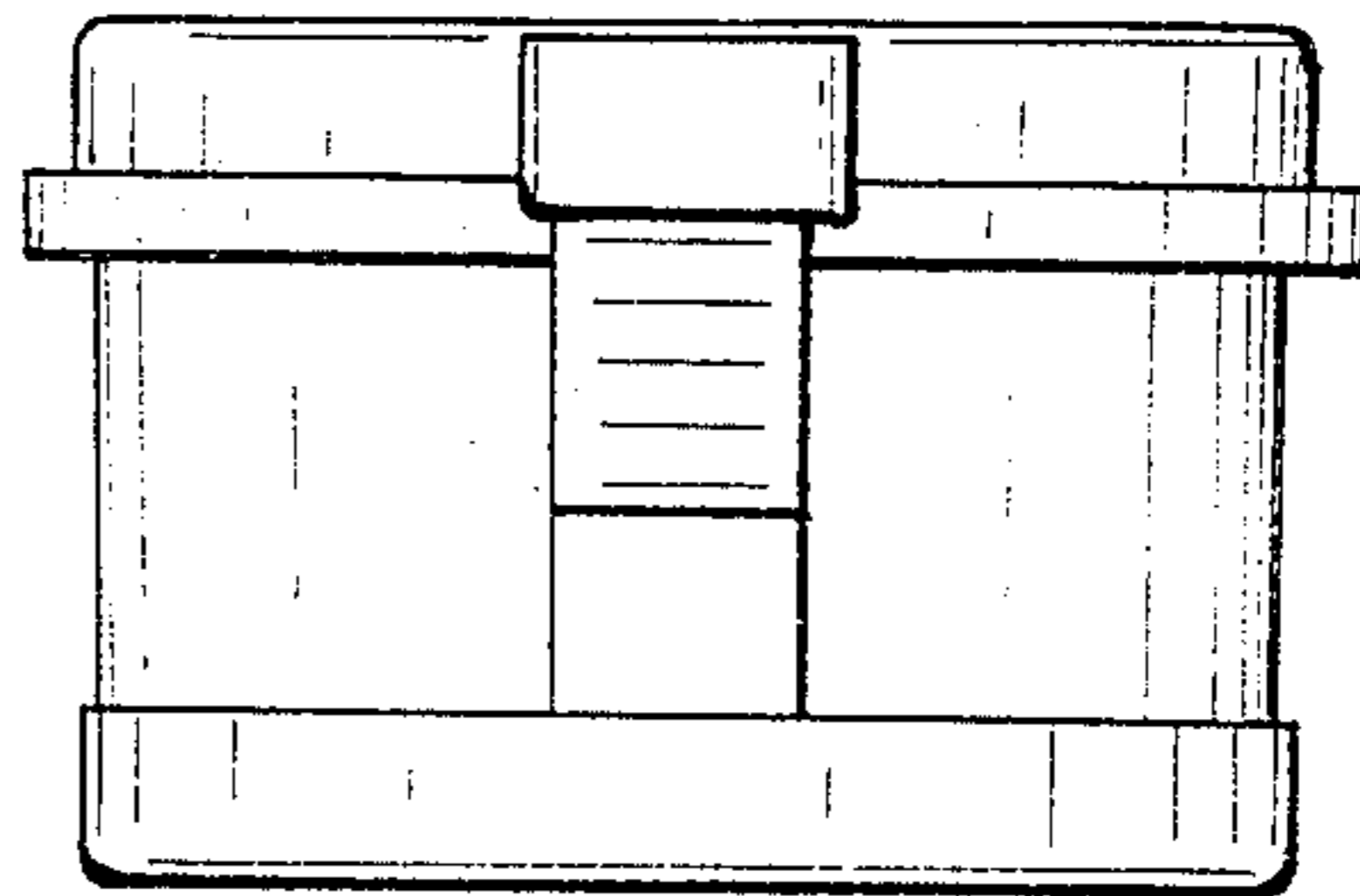

FIG. 5

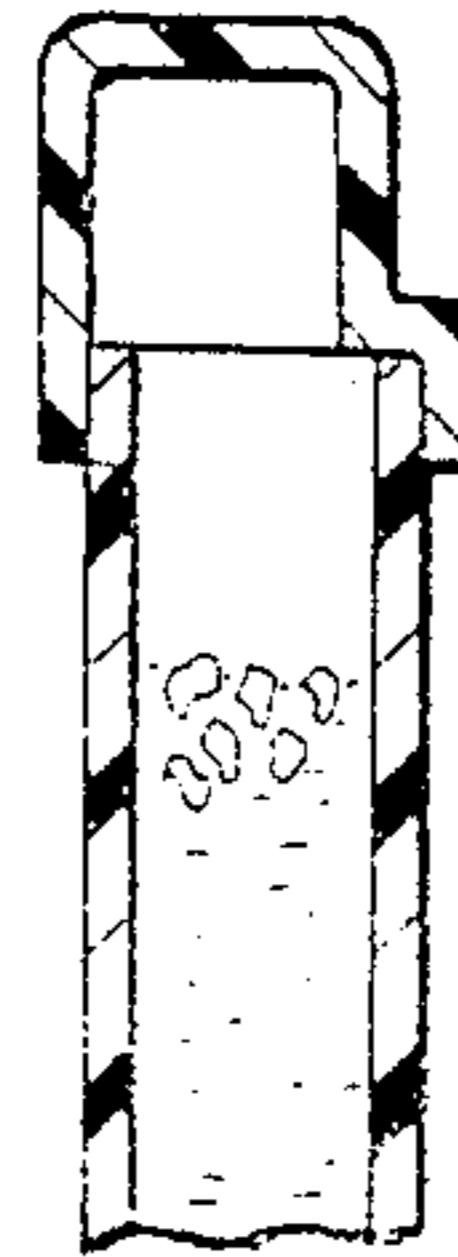

FIG. 6