

[54] INFANT BATH TUB

[75] Inventor: Paul Thom, Woburn, Mass.

[73] Assignee: Kiddie Products, Inc., Avon, Mass.

[**] Term: 14 Years

[21] Appl. No.: 898,027

[22] Filed: Aug. 19, 1986

[52] U.S. Cl. D23/278

[58] Field of Search D23/277-282;
4/571-575, 578, 589, 590

[56] References Cited

U.S. PATENT DOCUMENTS

D. 179,537	1/1957	Floyd	D23/278
D. 181,634	12/1957	Englehart	.	
D. 187,127	2/1960	Smith	D23/278
D. 221,768	9/1971	Savedra	D23/278
D. 236,000	7/1975	Powell	.	
D. 271,990	12/1983	Lyne	D23/278
D. 274,167	6/1984	Lyne	D23/278
D. 286,810	11/1986	Greene	D23/278
D. 288,955	3/1987	Greene	D23/278
D. 289,319	4/1987	Kujawski	D23/278
D. 289,791	5/1987	Schremmer	D23/278
1,512,068	10/1924	Thornburg	.	
1,797,777	3/1931	Krauss	.	
2,957,184	10/1960	Smith	.	
2,973,889	3/1961	Phillips	.	
3,496,579	2/1970	Petersen	.	
4,216,552	8/1980	Gurolnick	.	
4,561,135	12/1985	Adriaansen	.	

FOREIGN PATENT DOCUMENTS

708717	5/1954	United Kingdom	.
776090	6/1957	United Kingdom	.
1101524	1/1968	United Kingdom	.
2038177	7/1980	United Kingdom	.

Primary Examiner—James R. Largen

[57] CLAIM

The ornamental design for an infant bath tub, as shown and described.

DESCRIPTION

FIG. 1 is an isometric view of an infant bath tub showing my new design;
 FIG. 2 is a top plan view thereof;
 FIG. 3 is a bottom plan view thereof;
 FIG. 4 is a side elevational view thereof;
 FIG. 5 is an end elevational view thereof;
 FIG. 6 is an elevational view taken from the side opposite that shown in FIG. 4;
 FIG. 7 is an elevational view taken from the end opposite that shown in FIG. 5;
 FIG. 8 is a cross-sectional view taken on line 8—8 of FIG. 2;
 FIG. 9 is a cross-sectional view thereof taken on line 9—9 of FIG. 2;
 FIG. 10 is a cross-sectional view thereof taken on line 10—10 of FIG. 2;
 FIG. 11 is a cross-sectional view thereof taken on line 11—11 of FIG. 2;
 FIG. 12 is a cross-sectional view thereof taken on line 12—12 of FIG. 4;
 FIG. 13 is a cross-sectional view thereof taken on line 13—13 of FIG. 4;
 FIG. 14 is a cross-sectional view thereof taken on line 14—14 of FIG. 4;
 FIG. 15 is a cross-sectional view thereof taken on line 15—15 of the FIG. 4;
 FIG. 16 is a cross-sectional view thereof on line 16—16 of FIG. 4; and,
 FIG. 17 is a cross-sectional view thereof taken on line 17—17 of FIG. 4.

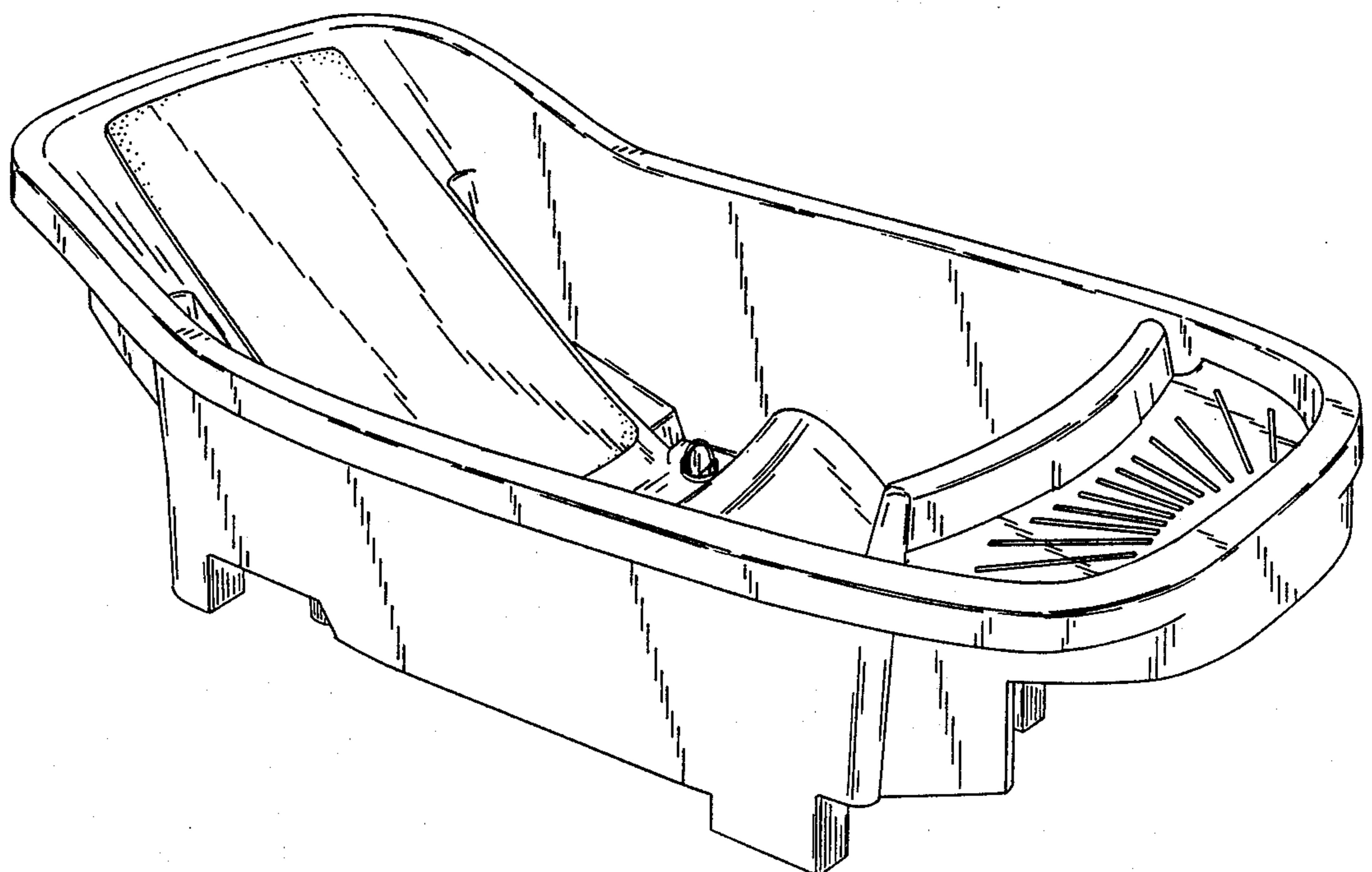

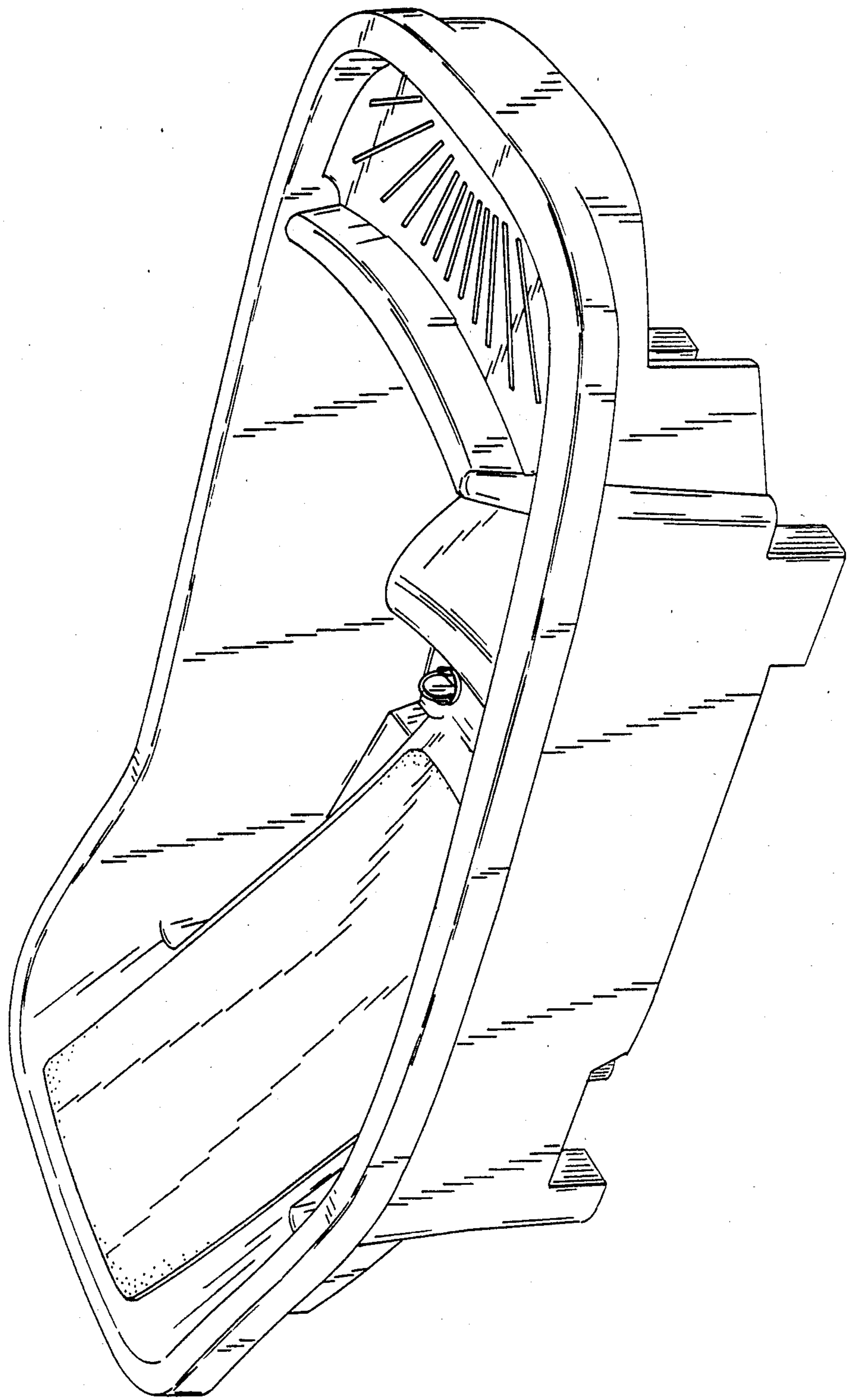

FIG 1

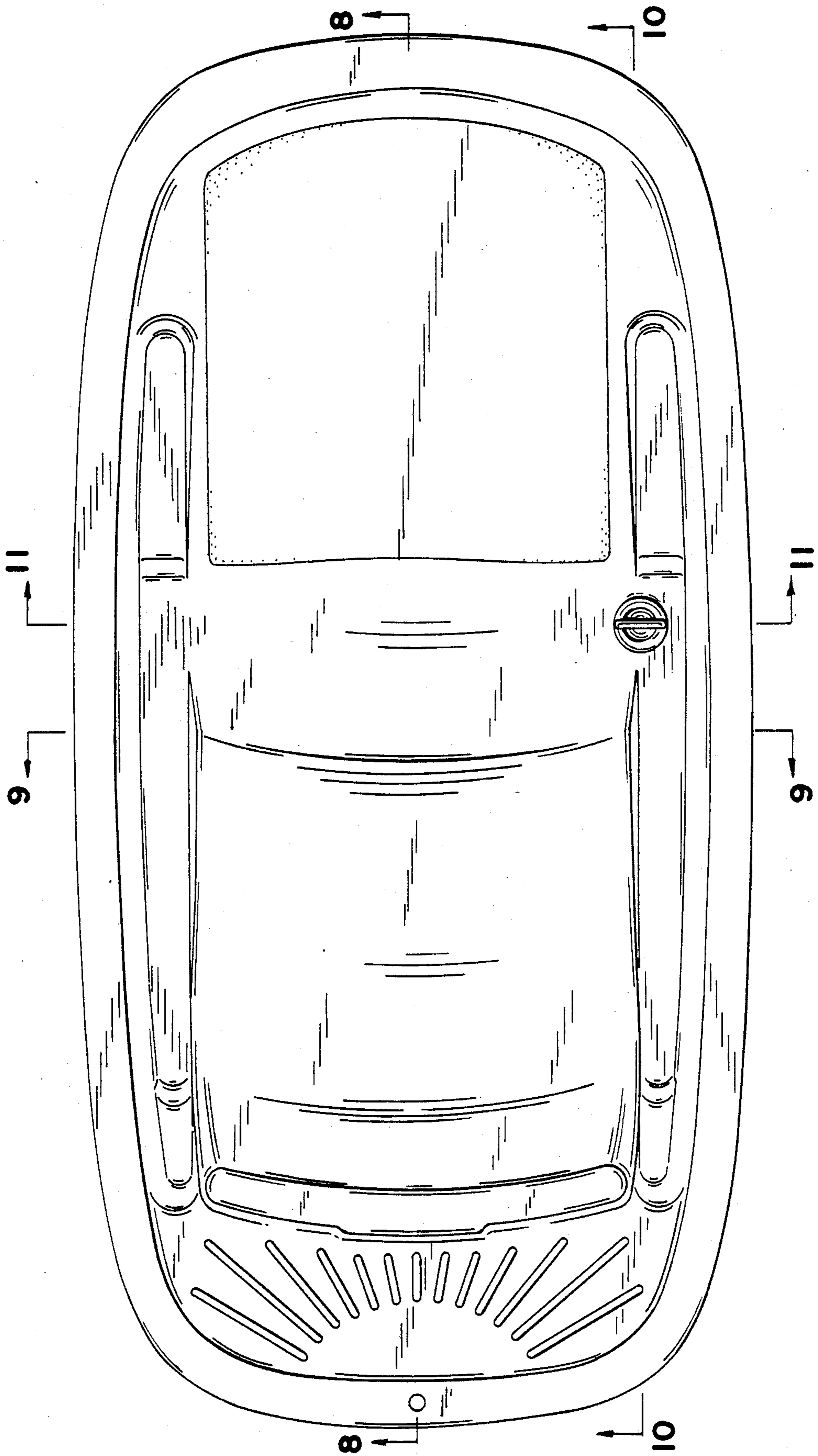

FIG 2

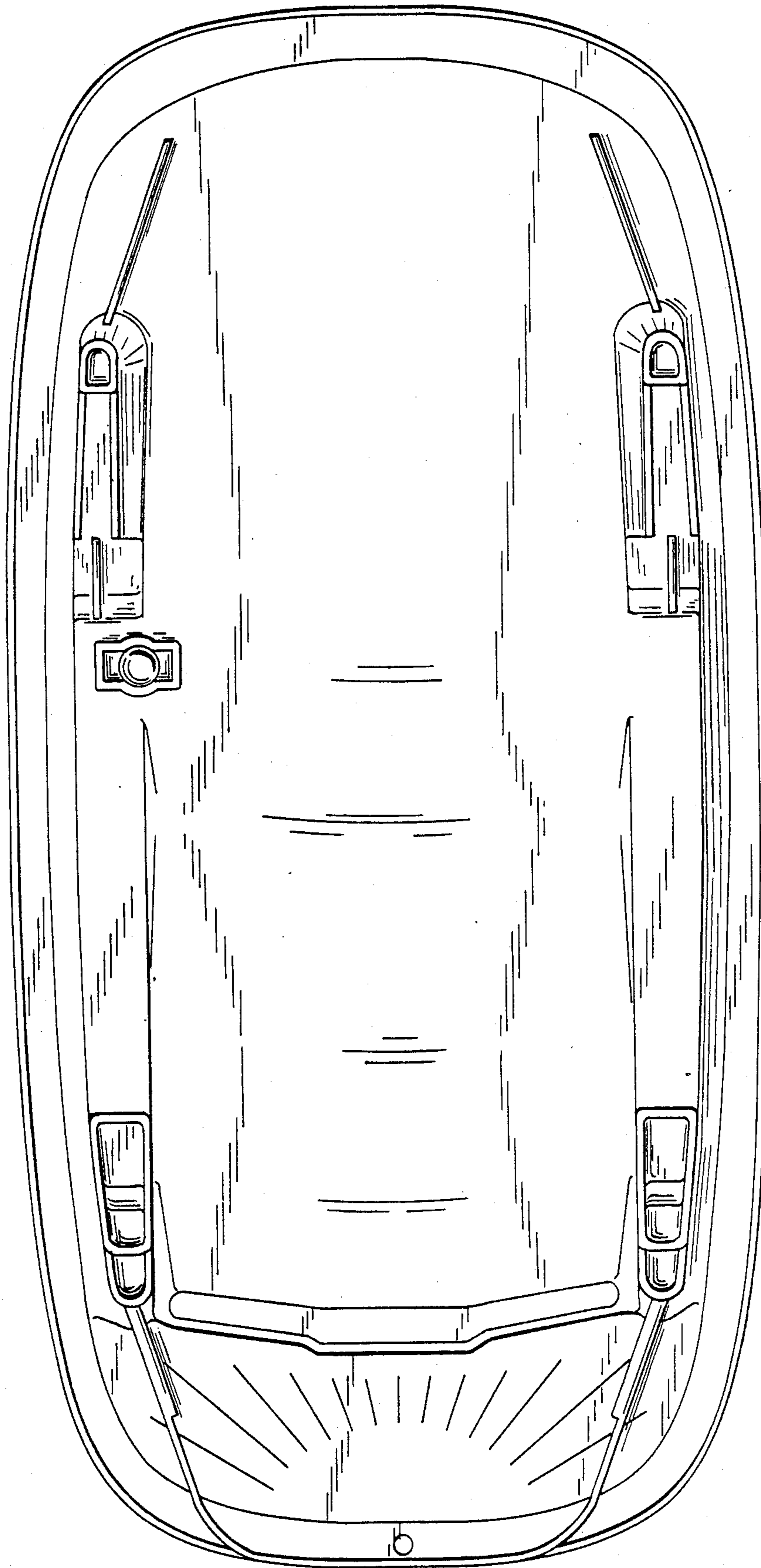

FIG 3

FIG 5

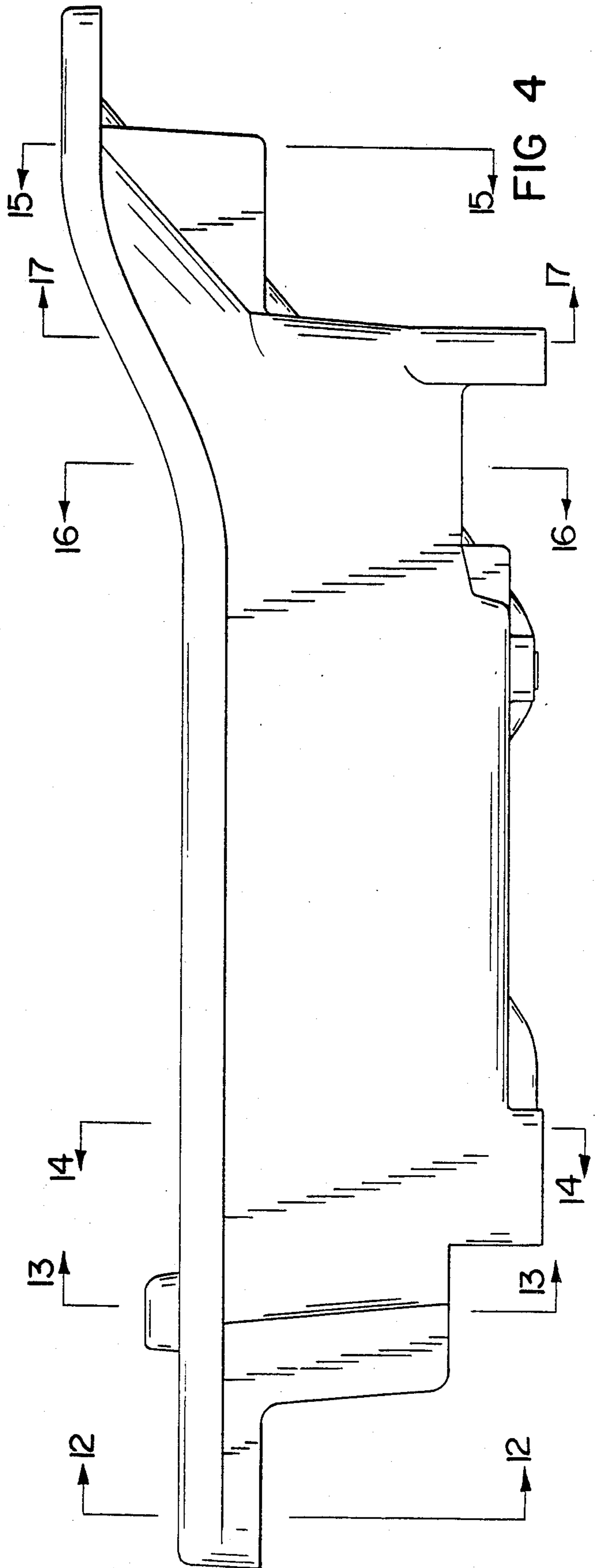
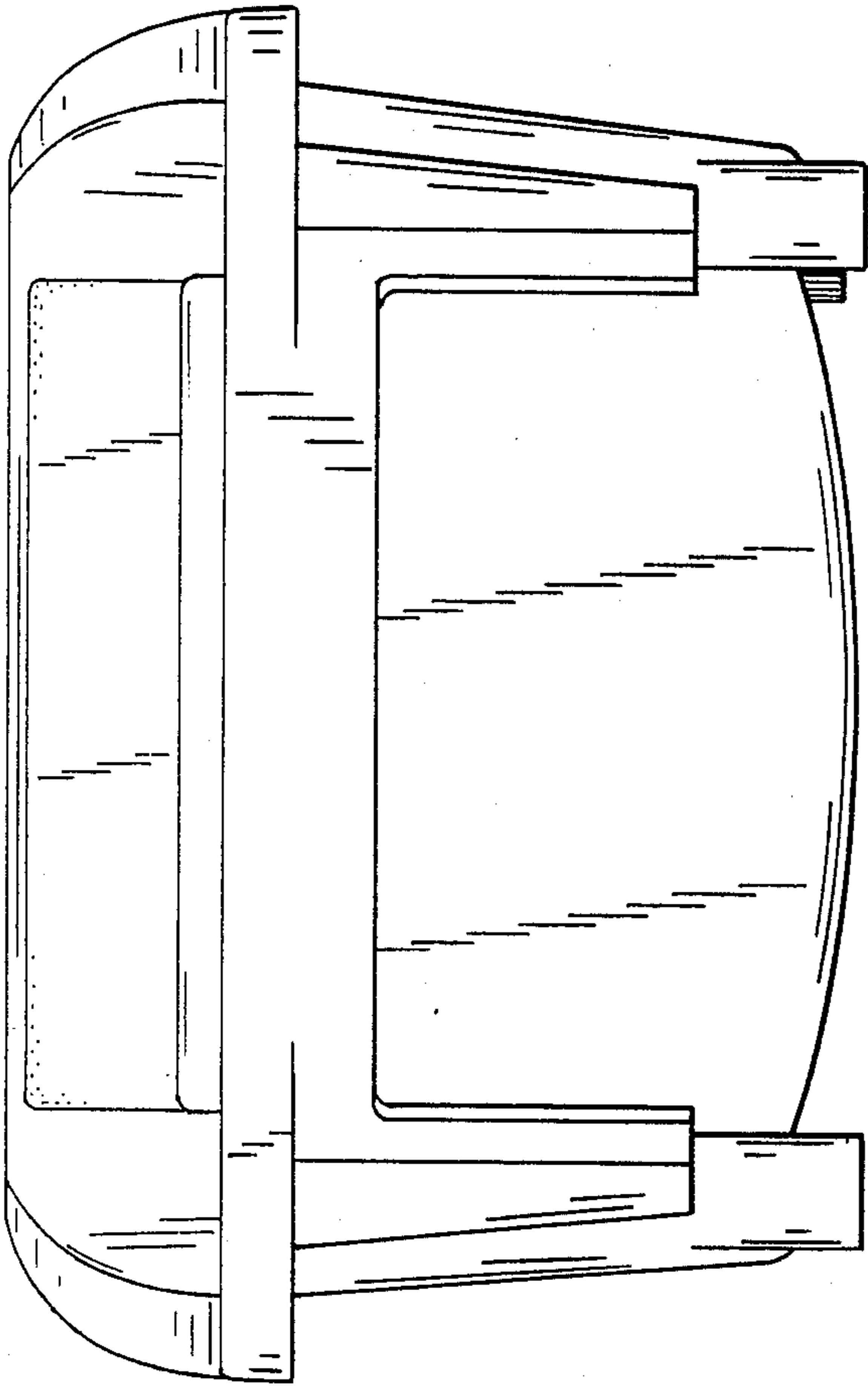

FIG 4

FIG 7

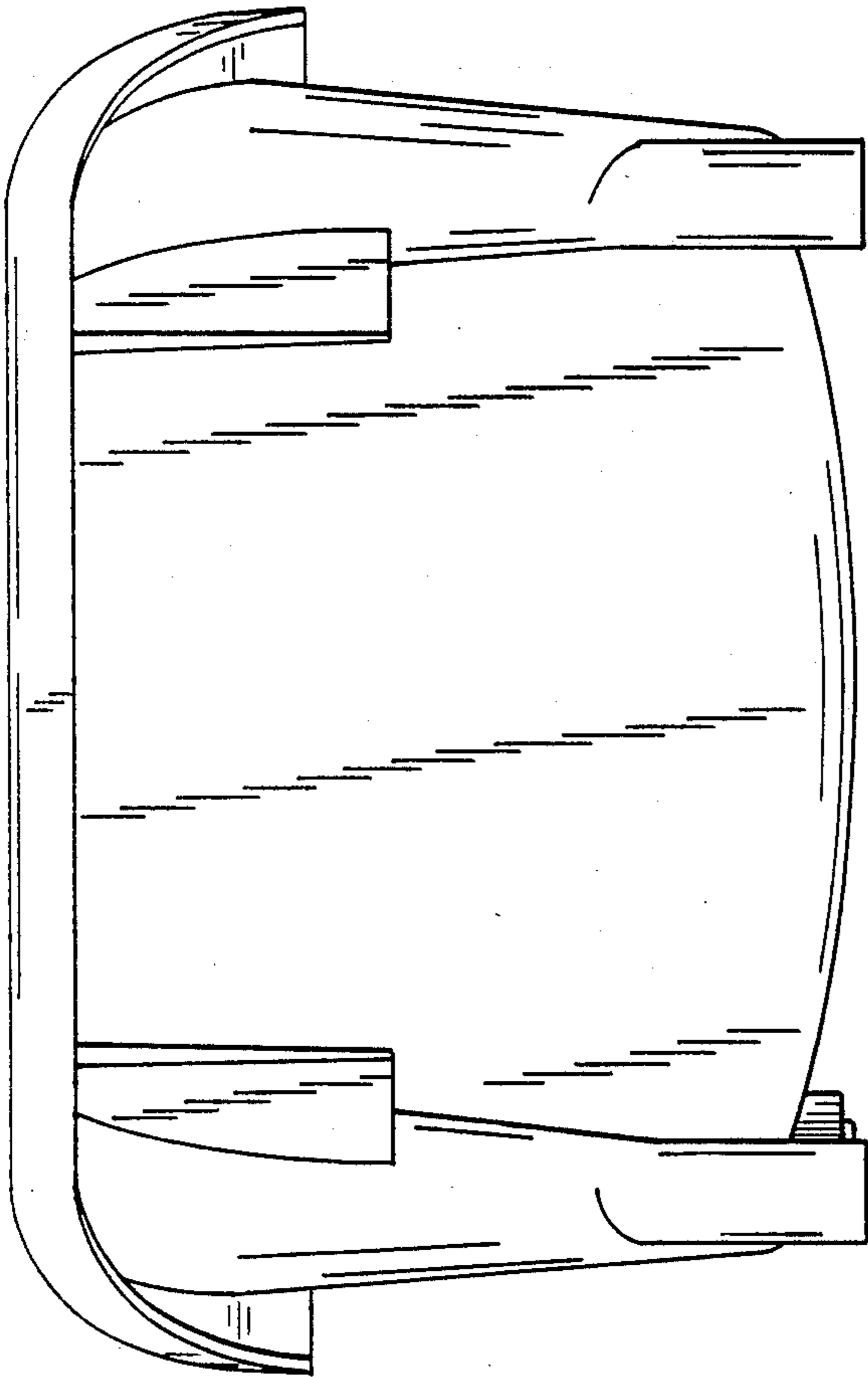

FIG 6

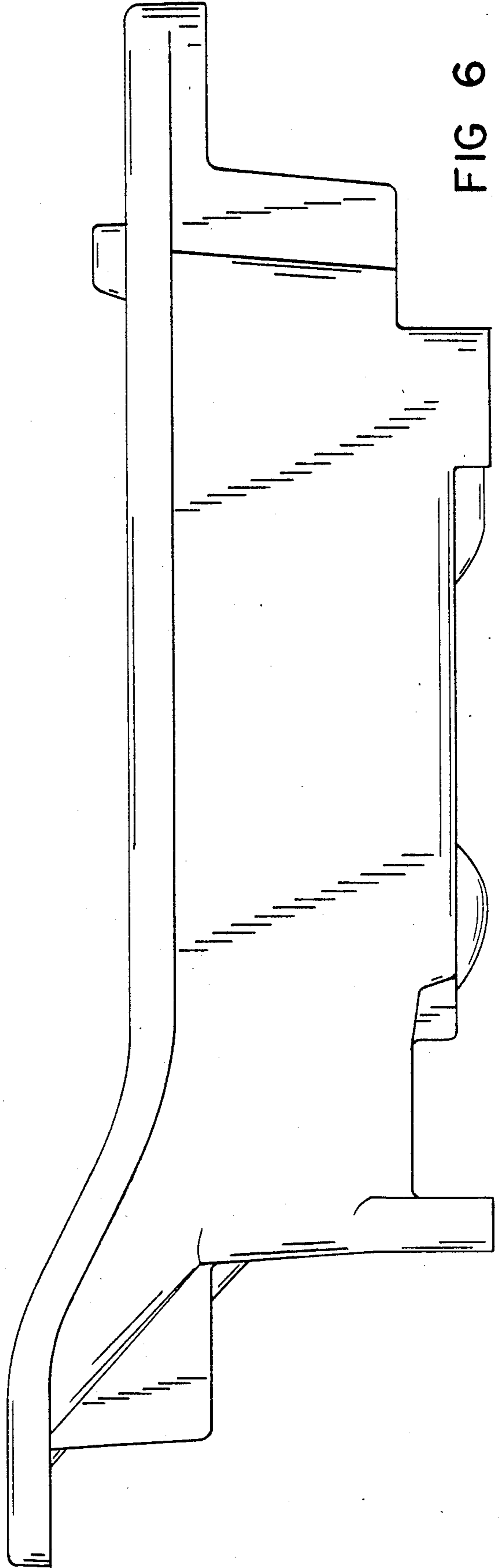

FIG 9

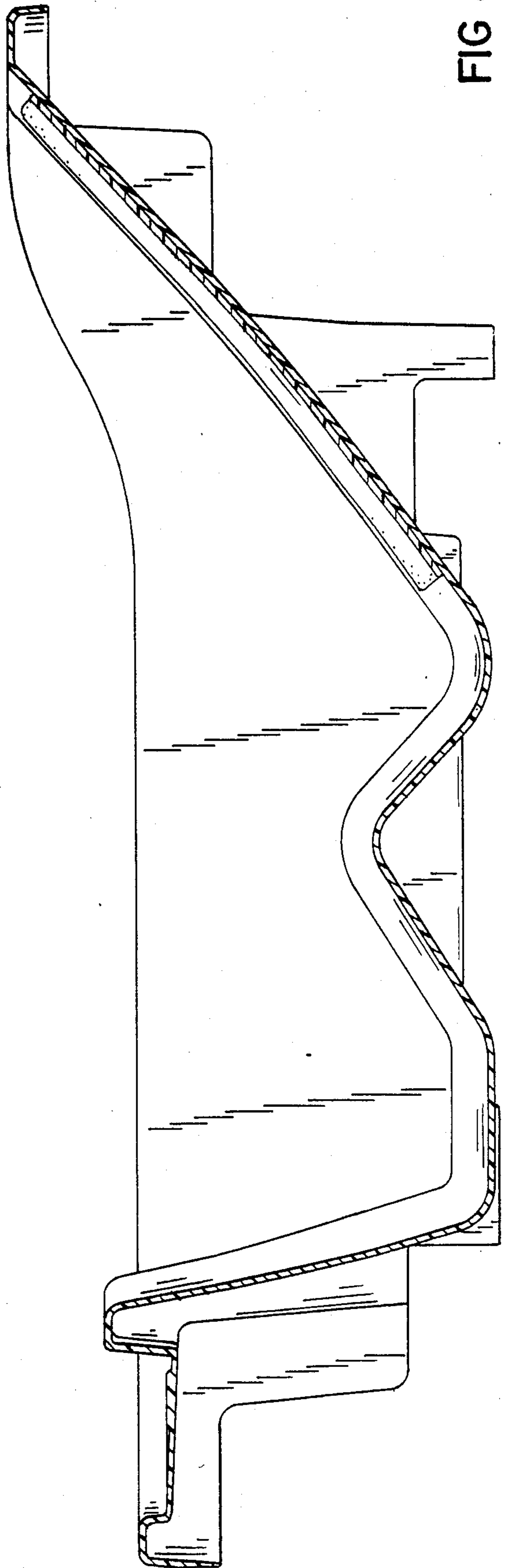
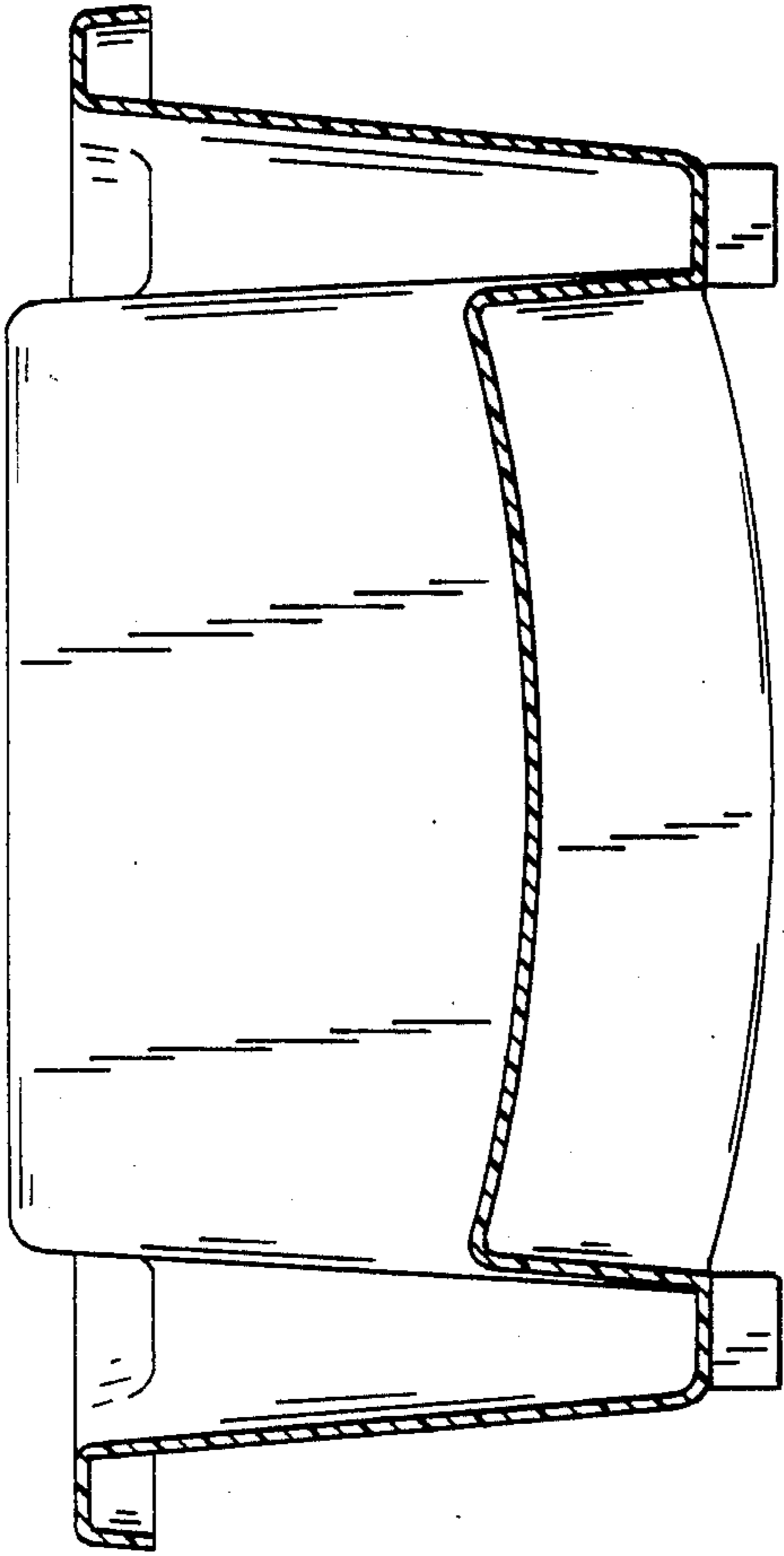

FIG 8

FIG 11

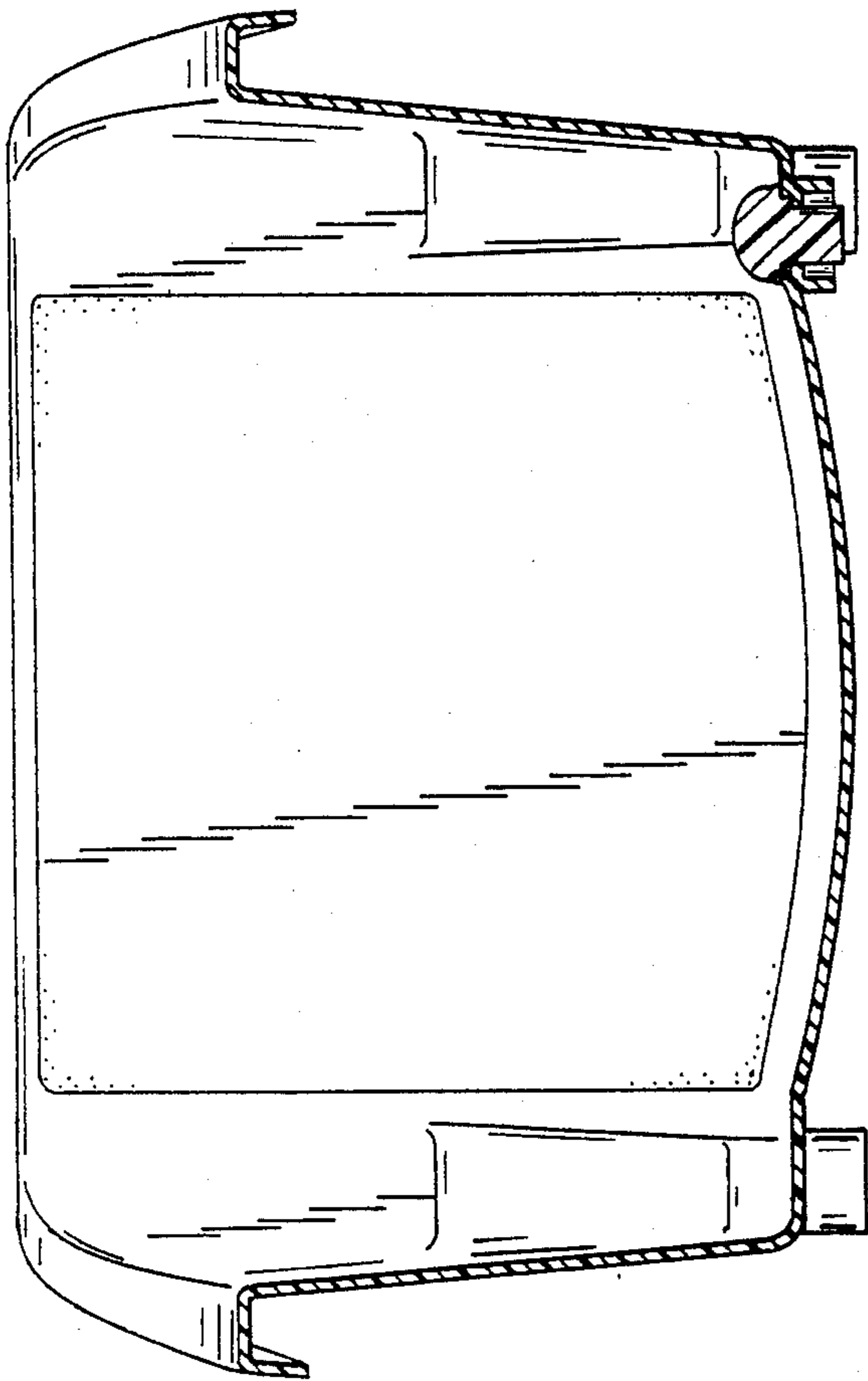

FIG 10

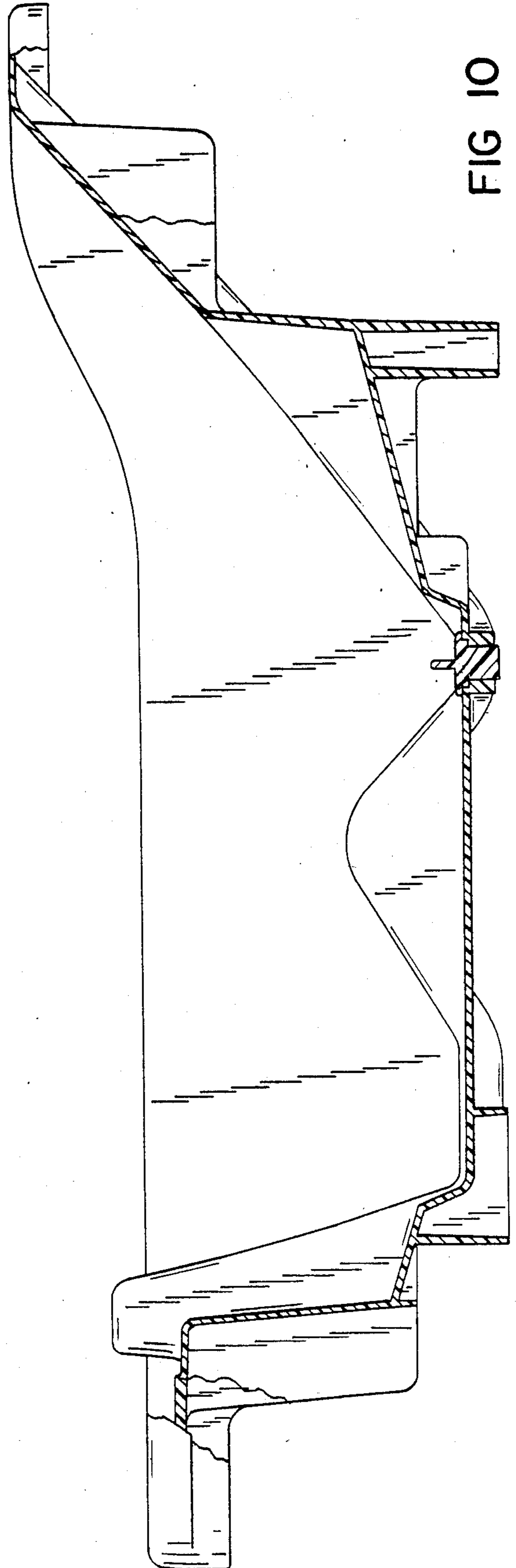

FIG 12

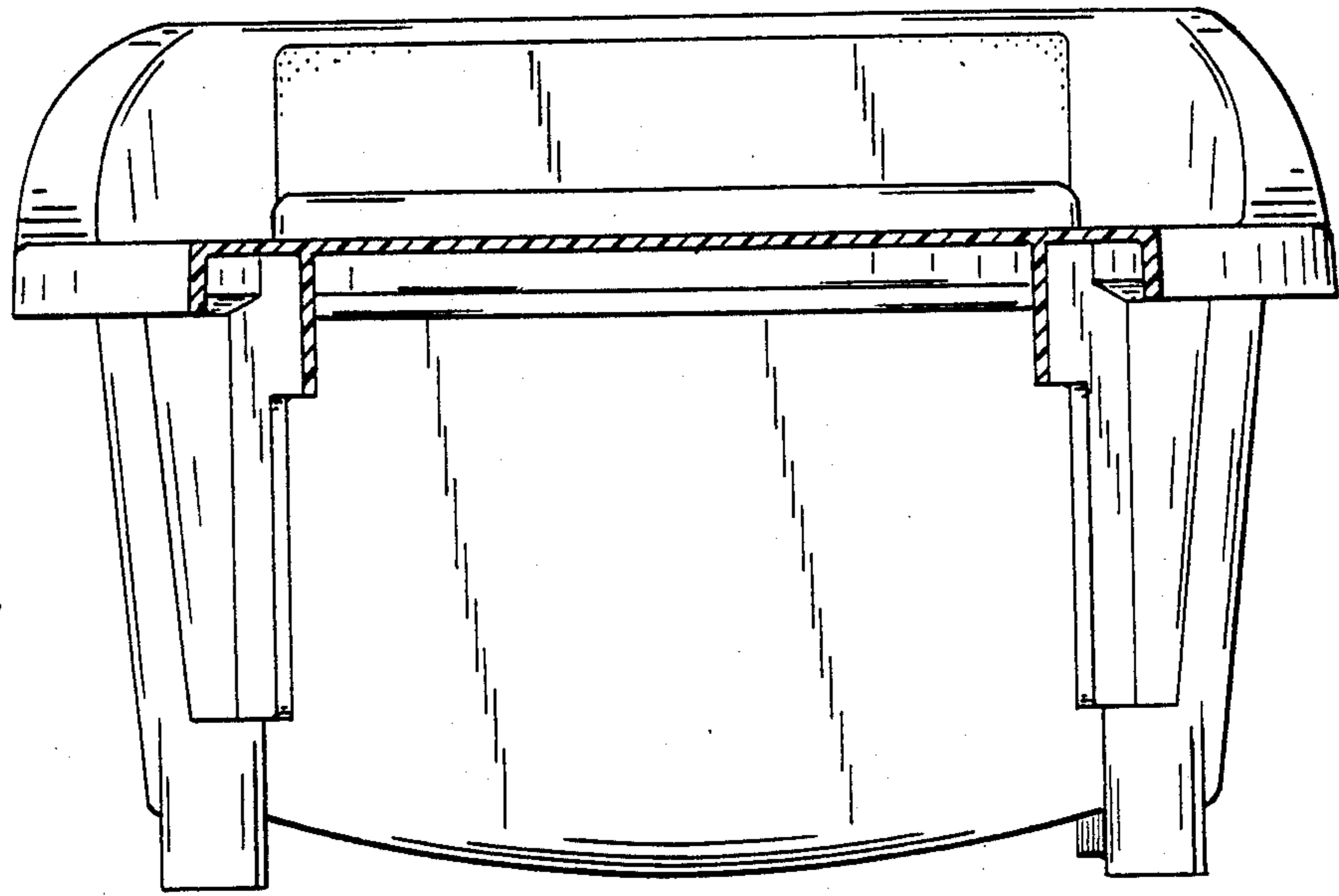

FIG 13

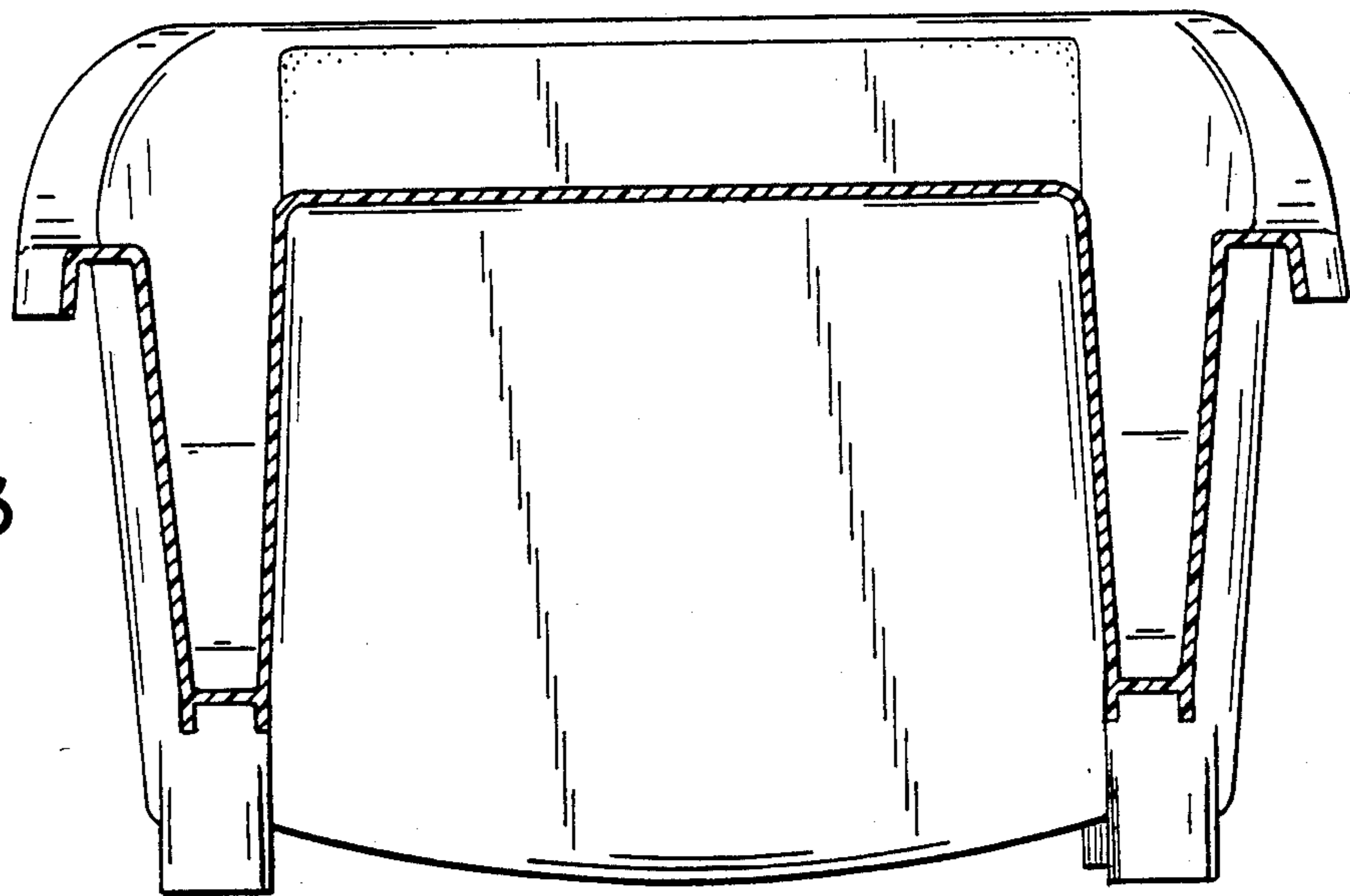

FIG 14

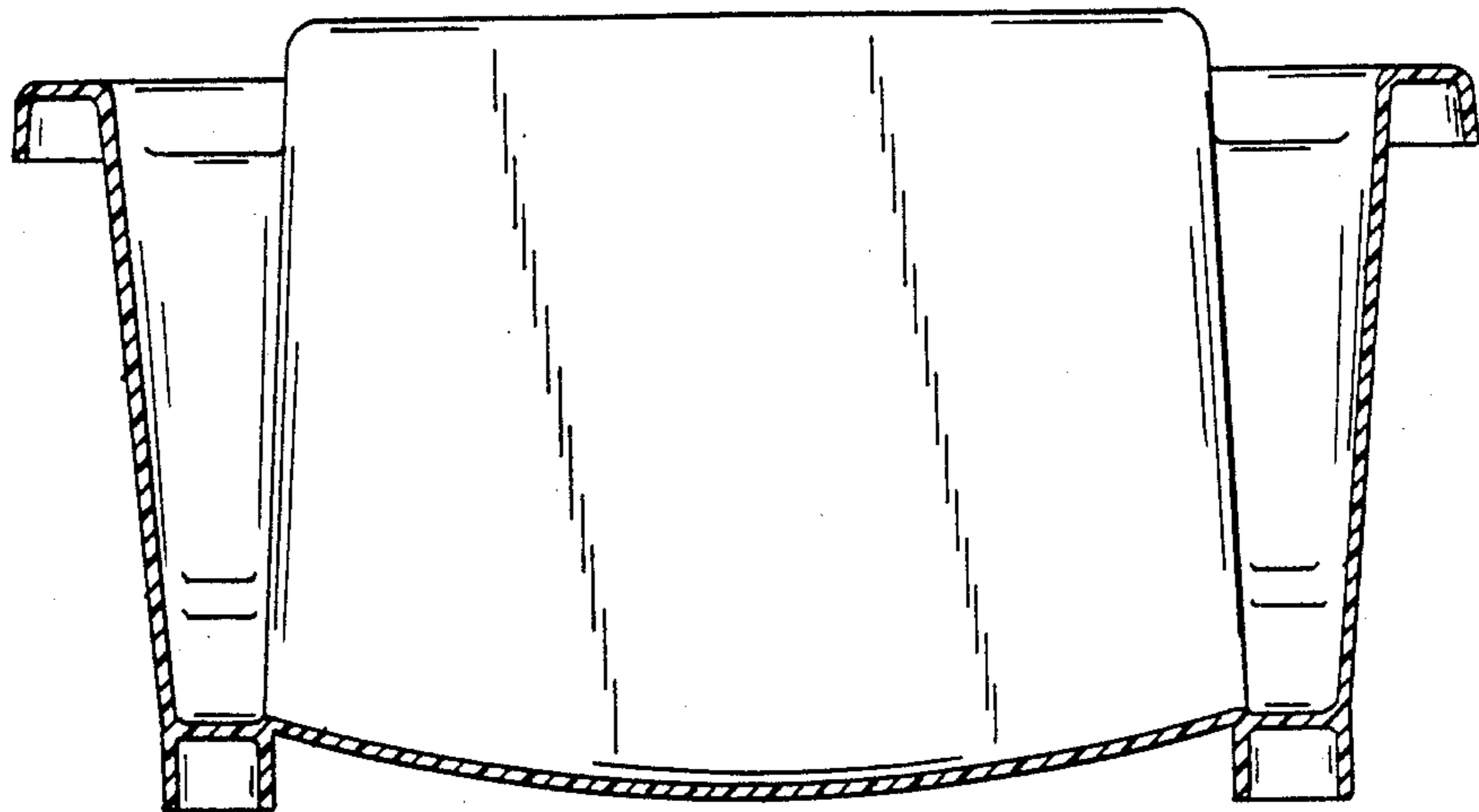

FIG 15

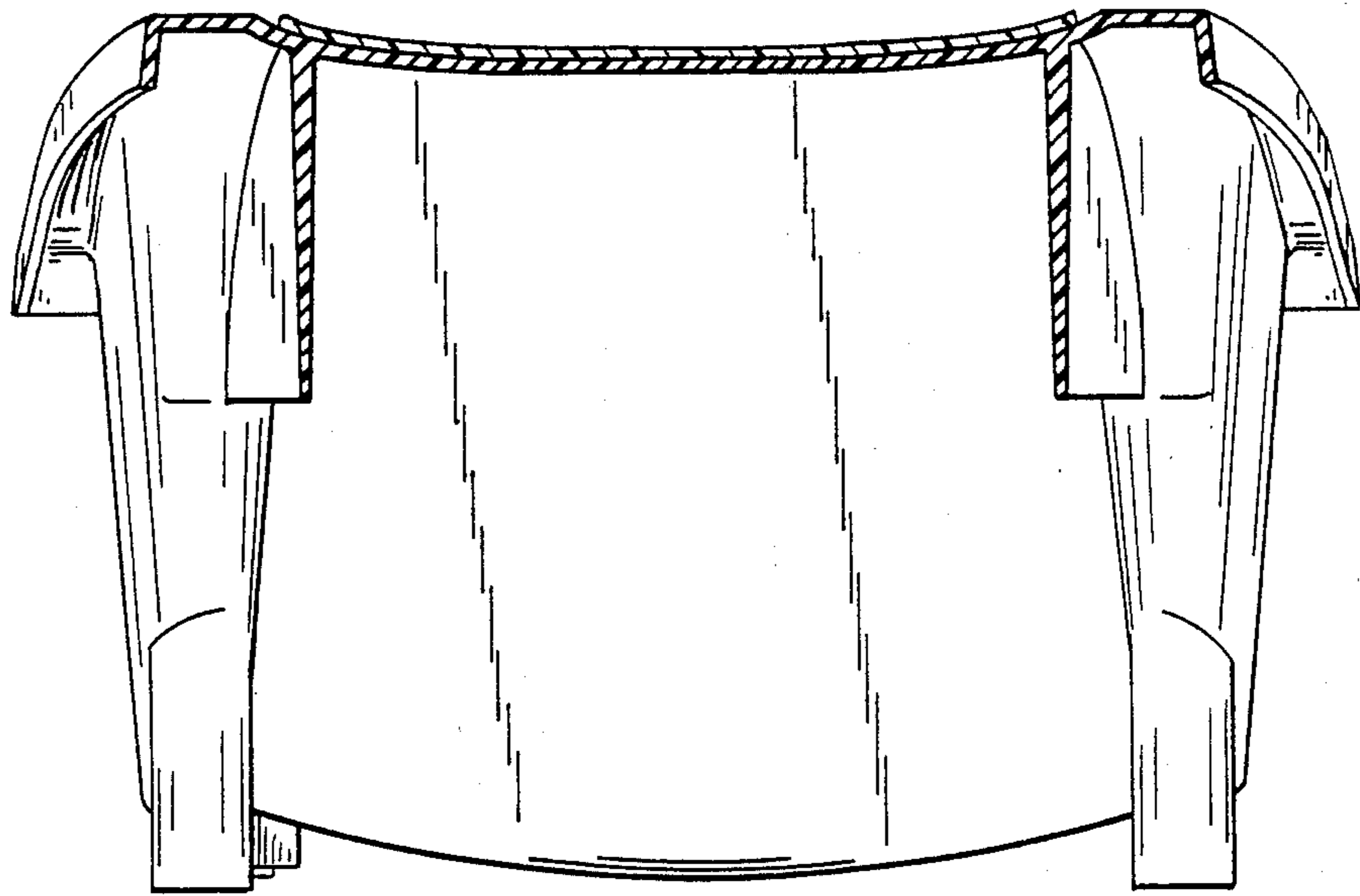

FIG 16

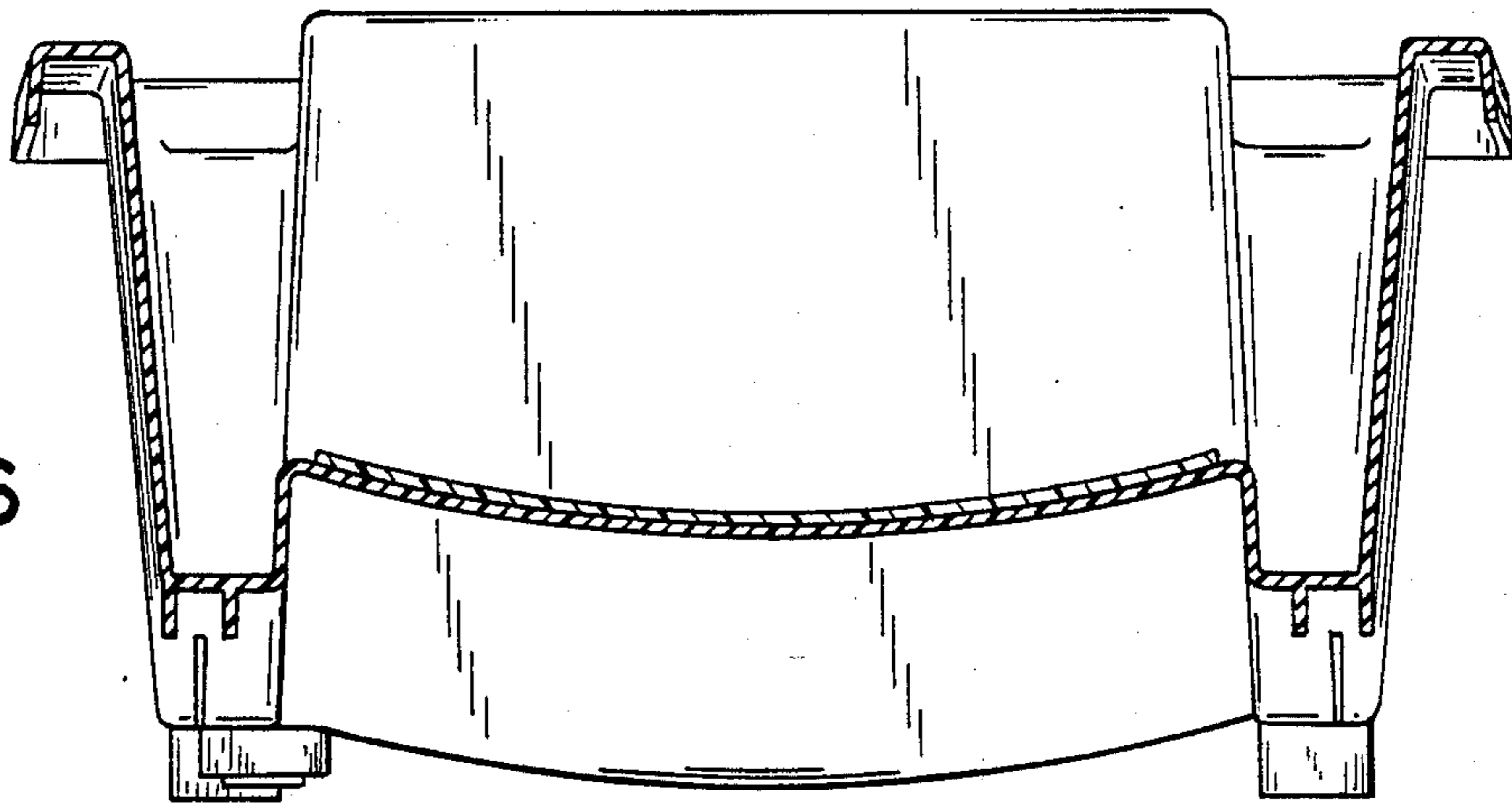

FIG 17

