

[54] **BINOCULARS**

[75] Inventor: **Akira Aoki, Tokyo, Japan**
[73] Assignee: **Seiwa Instruments Mfg. Co., Ltd.,
Saitama, Japan**
[**] Term: **14 Years**
[21] Appl. No.: **773,932**
[22] Filed: **Sep. 9, 1985**

[30] **Foreign Application Priority Data**

Apr. 9, 1985 [JP] Japan 60-14056
[52] U.S. Cl. **D16/133**
[58] Field of Search D16/133, 130, 132;
350/553, 550, 551, 552, 554, 546

[56] **References Cited**

U.S. PATENT DOCUMENTS

D. 232,478 8/1974 Hornschu et al. D16/133

D. 238,304 12/1975 Hengst et al. D16/133

FOREIGN PATENT DOCUMENTS

0148017 8/1984 Japan 350/546

Primary Examiner—Wallace R. Burke
Assistant Examiner—Stella M. Reid
Attorney, Agent, or Firm—George B. Oujevolk

[57] **CLAIM**

The ornamental design for binoculars, as shown.

DESCRIPTION

FIG. 1 is a rear view of the binoculars of FIG. 7;
FIG. 2 is a front view thereof;
FIG. 3 is a right side view thereof;
FIG. 4 is a left side view thereof;
FIG. 5 is a top plan view thereof;
FIG. 6 is a bottom plan view thereof; and,
FIG. 7 is a top perspective view of binoculars, showing
my new design.

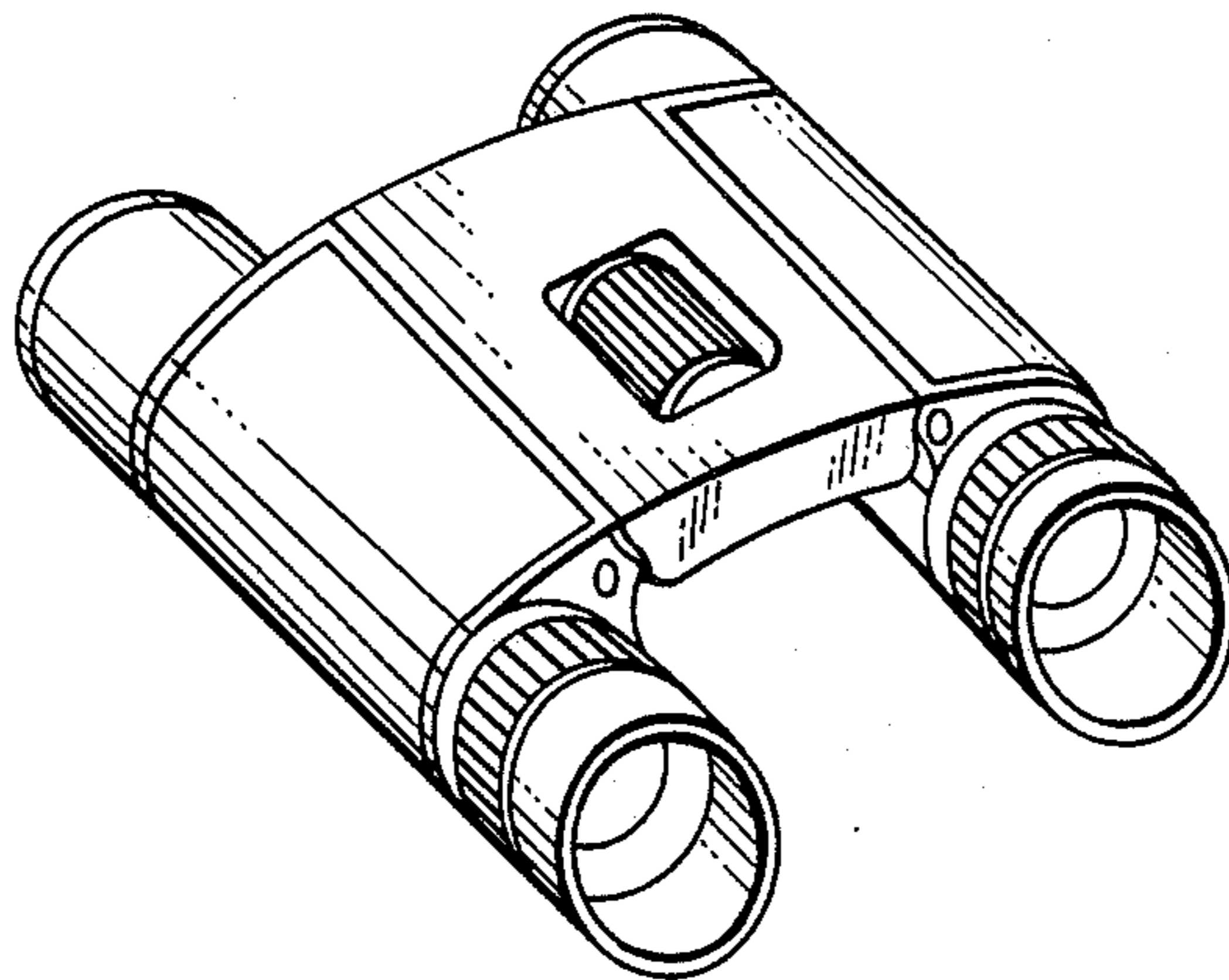

FIG. 1

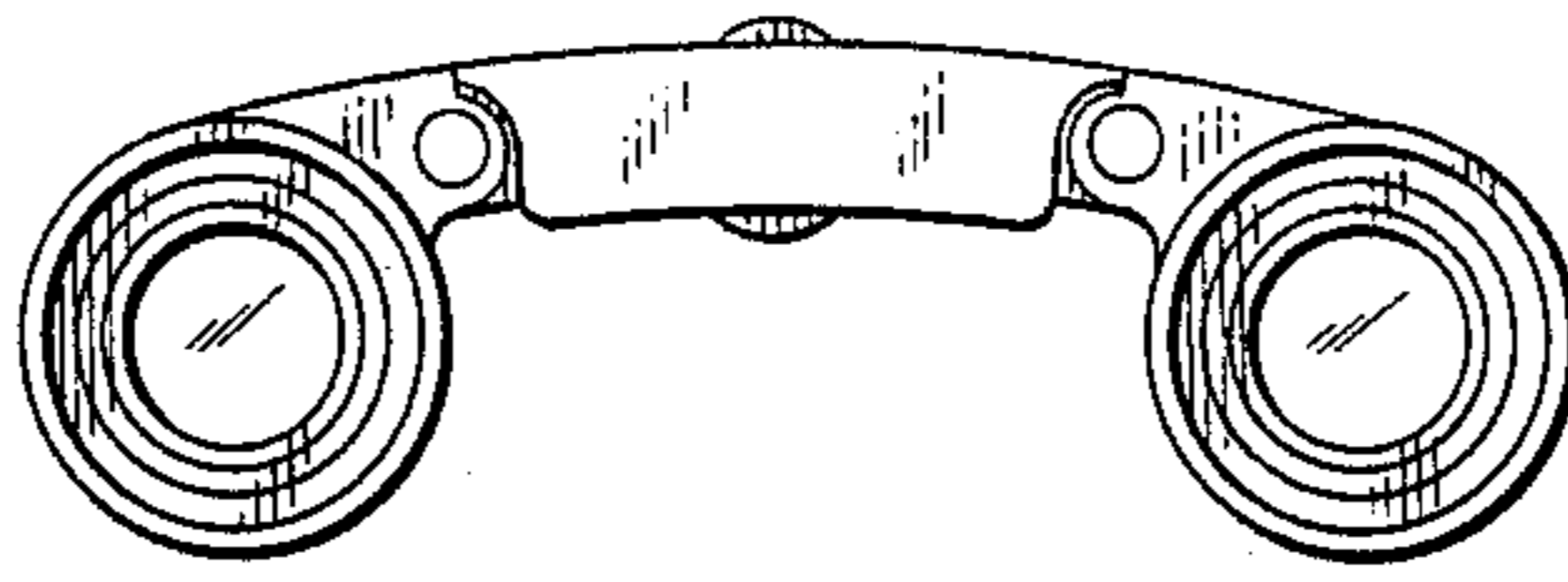

FIG. 2

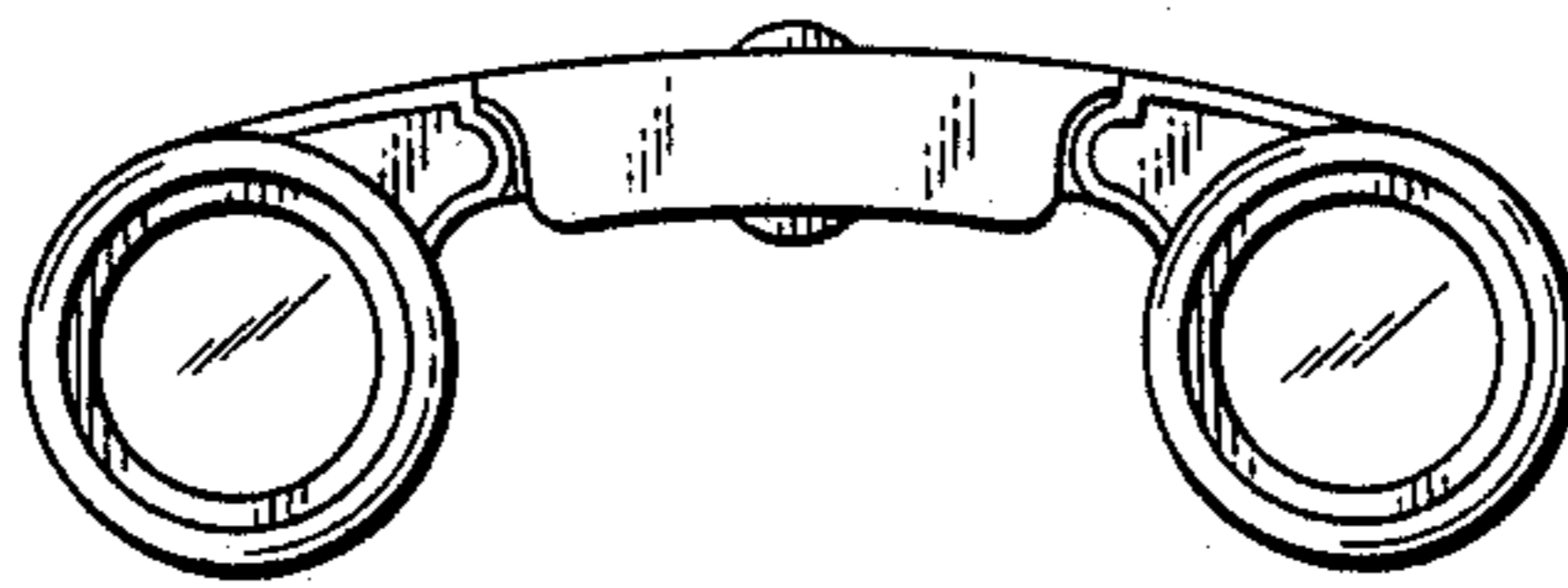

FIG. 3

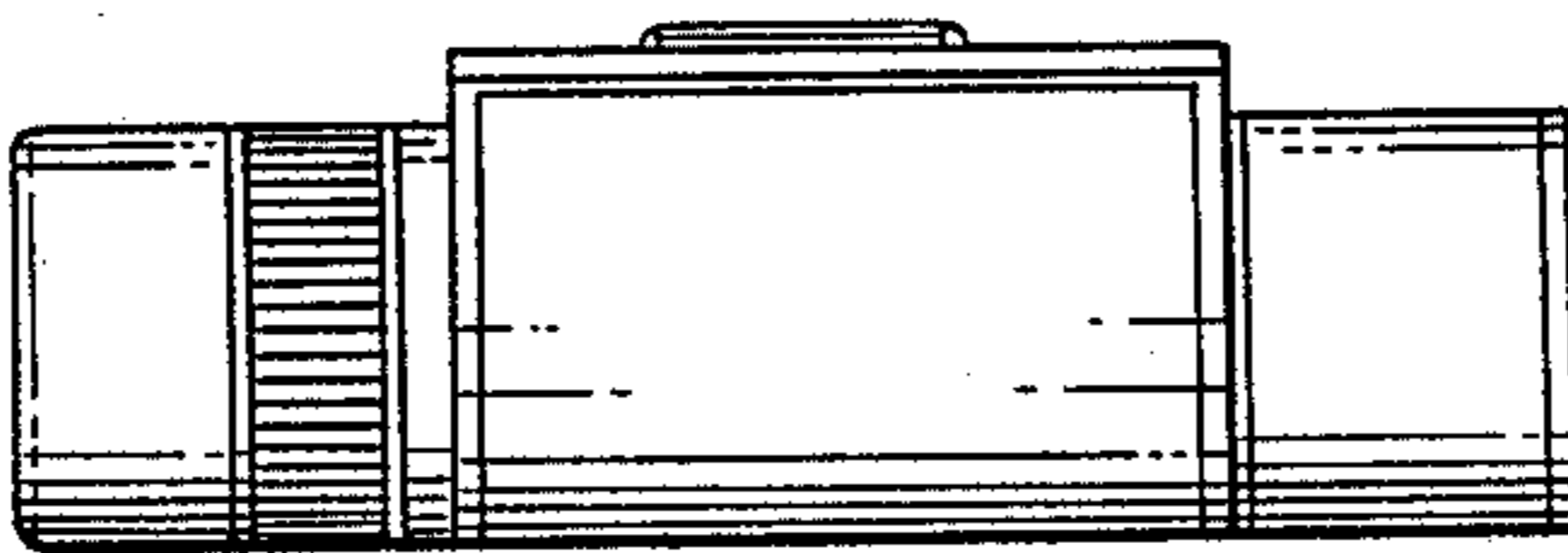

FIG. 4

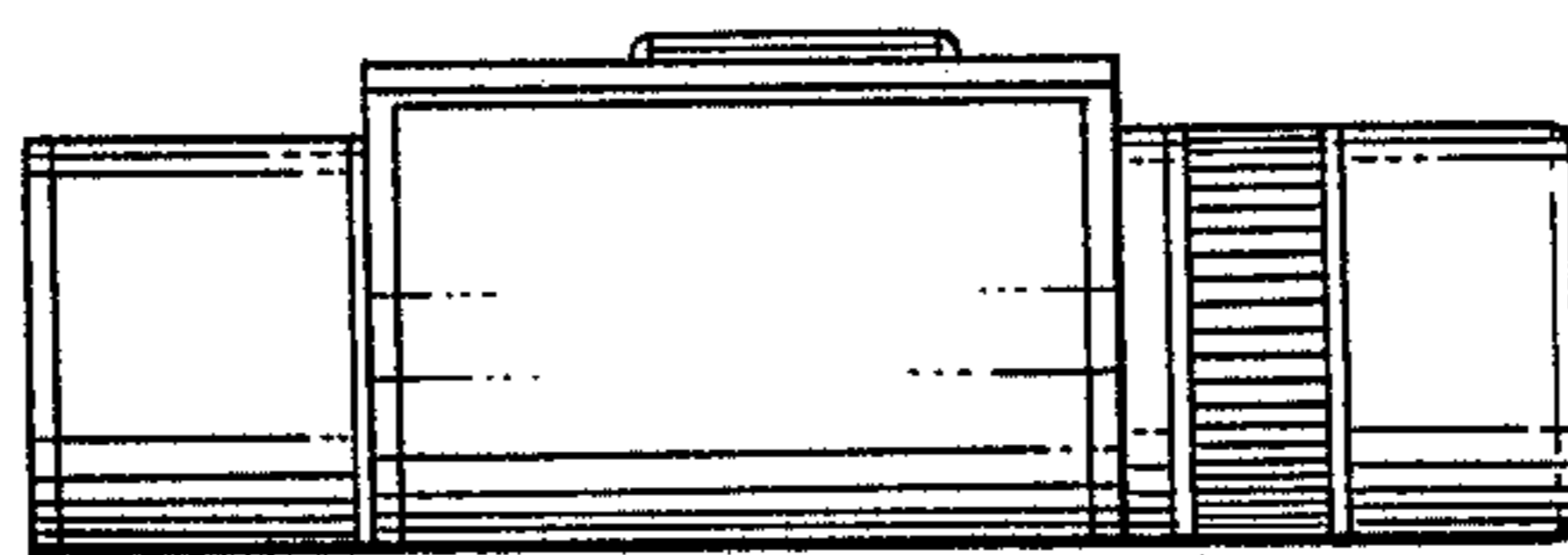

FIG. 5

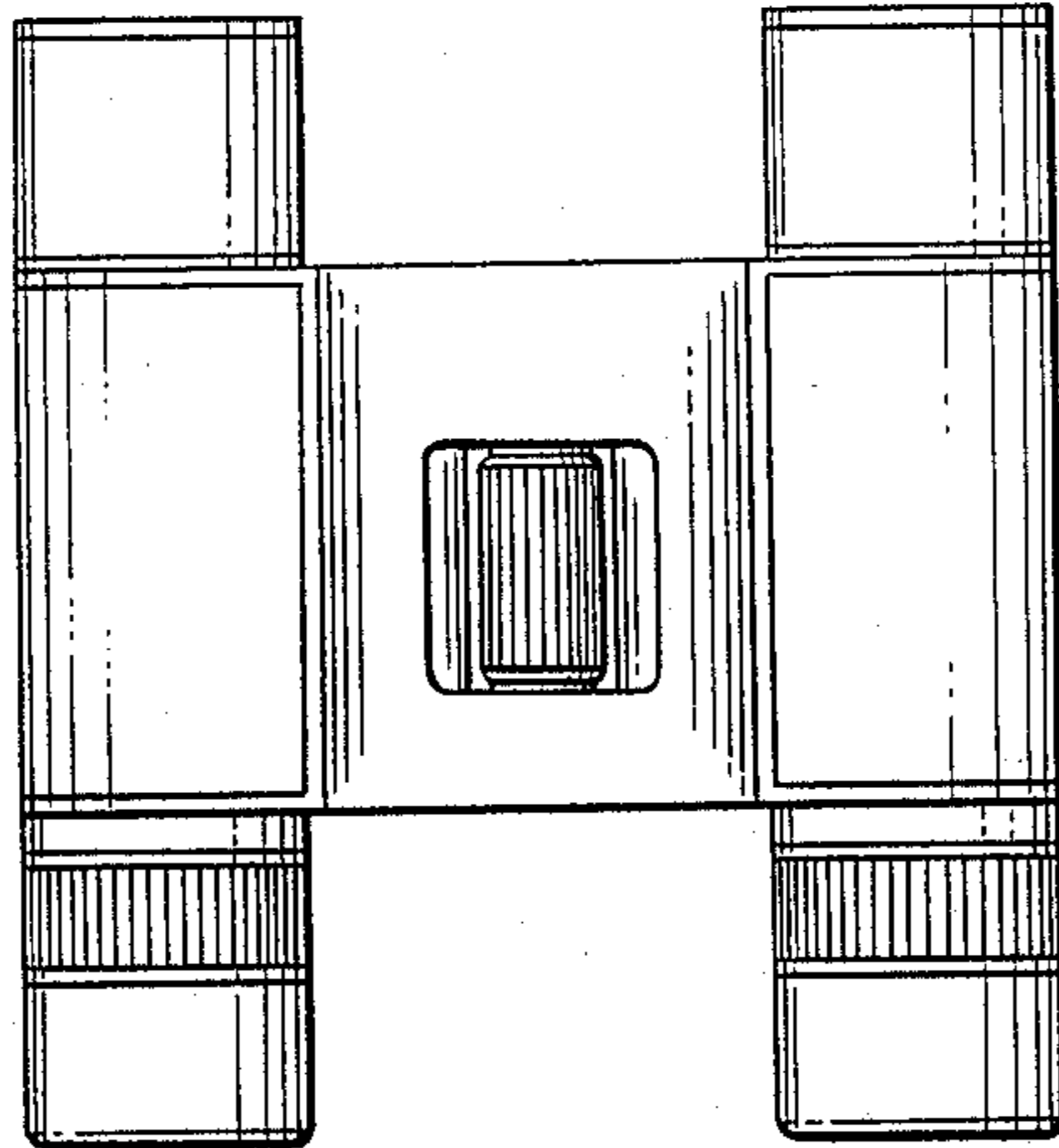

FIG. 6

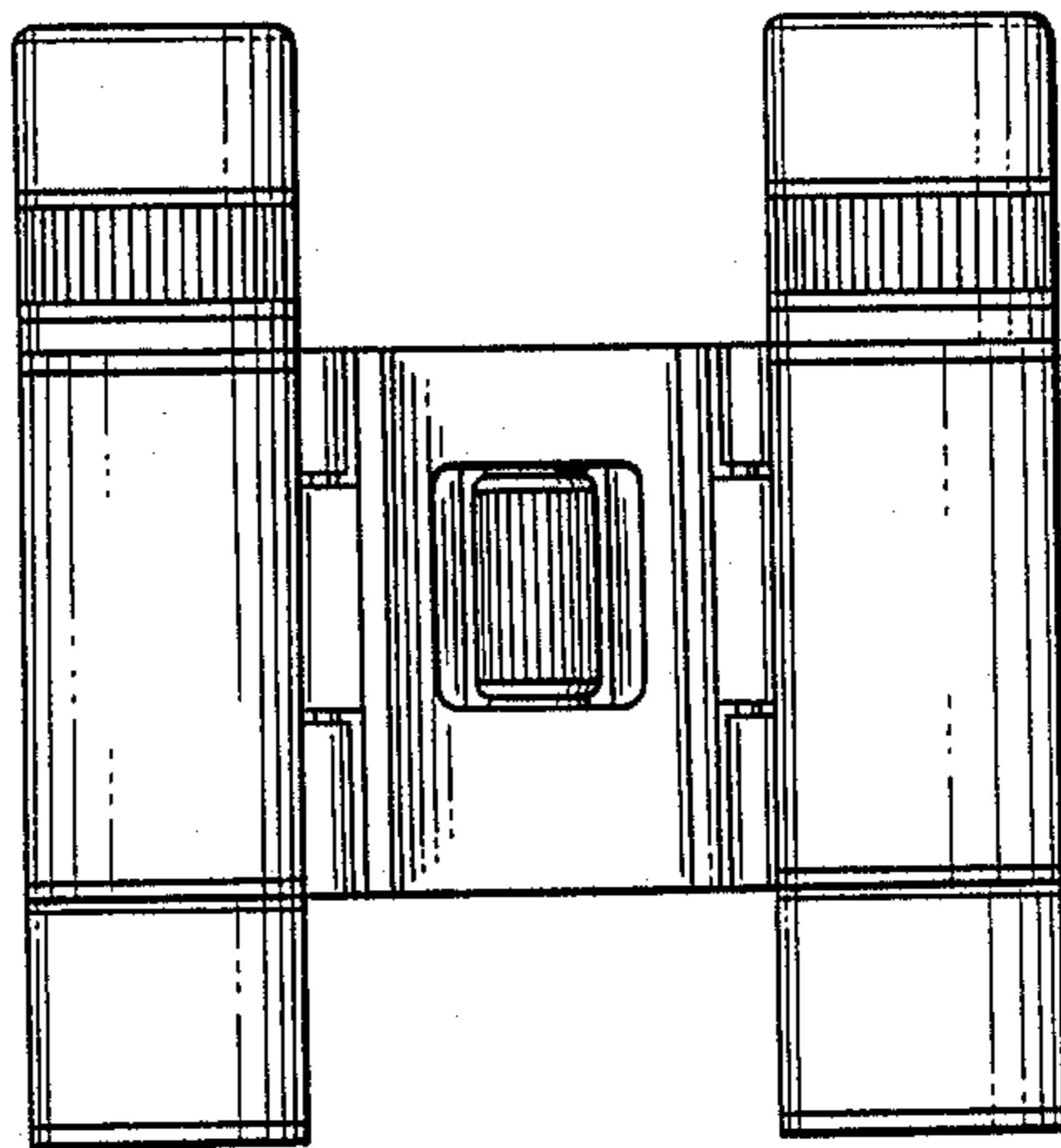

FIG. 7

