

# United States Patent [19]

Gandy

[11] Patent Number: Des. 299,545

[45] Date of Patent: \*\* Jan. 24, 1989

[54] AWNING FRAME MEMBER

[75] Inventor: James Gandy, Brampton, Canada

[73] Assignee: Signtech Inc., Mississauga, Canada

[\*\*] Term: 14 Years

[21] Appl. No.: 823,436

[22] Filed: Jan. 28, 1986

[30] Foreign Application Priority Data

Aug. 8, 1985 [CA] Canada ..... 08-08-8510

[52] U.S. Cl. .... D25/57

[58] Field of Search ..... 160/371, 57, 58.1, 378,  
160/77; 49/71; 52/64, 222; 362/152

[56] References Cited

U.S. PATENT DOCUMENTS

2,789,634 4/1957 Smith ..... 160/58.1

2,875,824 3/1959 Rice ..... 160/58.1

3,149,381 9/1964 Santo ..... 49/71

4,422,491 12/1983 Cusick, III ..... 160/58.1

Primary Examiner—A. Hugo Word

Attorney, Agent, or Firm—Robert F. Delbridge; Arne I. Fors

[57] CLAIM

The ornamental design for an awning frame member, as shown and described.

DESCRIPTION

FIG. 1 is a front perspective view of an awning frame member showing my new design;

FIG. 2 is a side view;

FIG. 3 is a top view;

FIG. 4 is a bottom view;

FIG. 5 is a front view; and

FIG. 6 is a rear view.

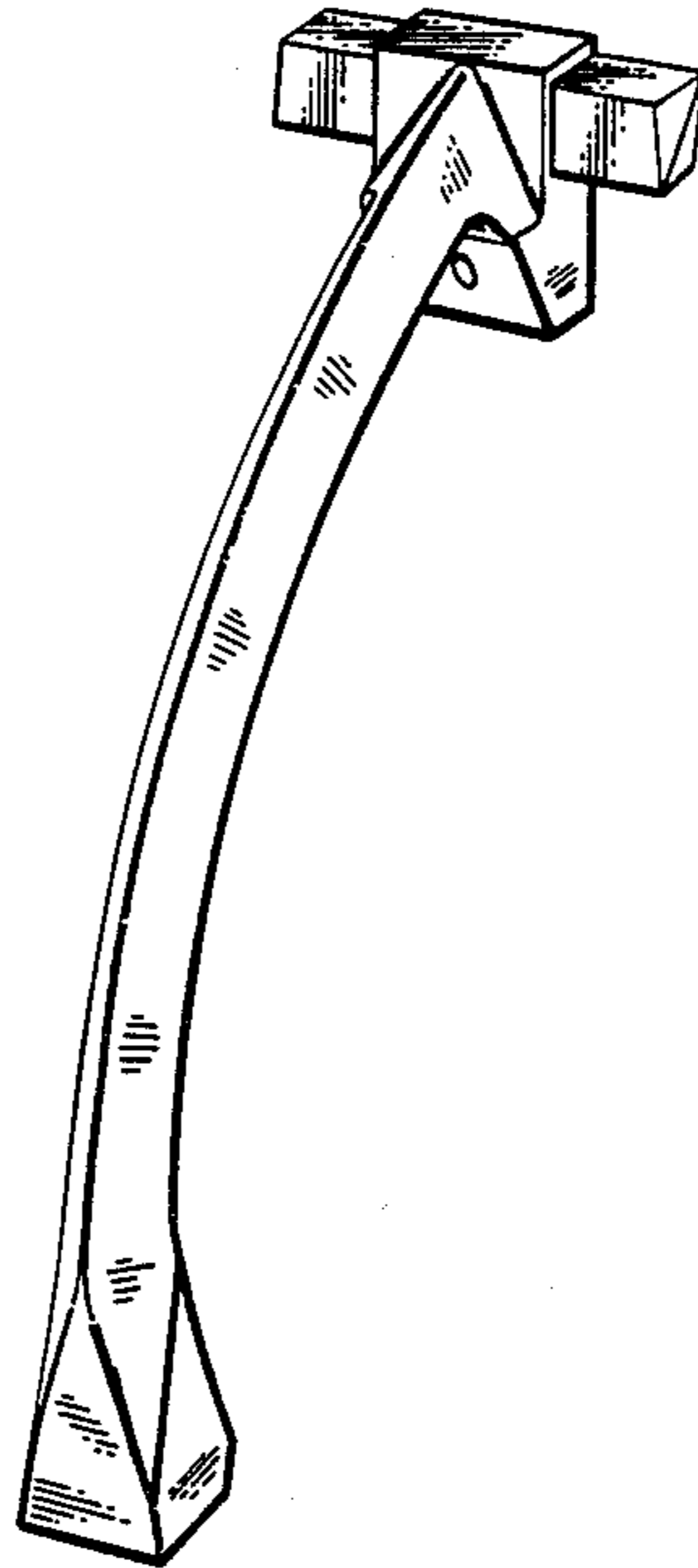

FIG. 1.

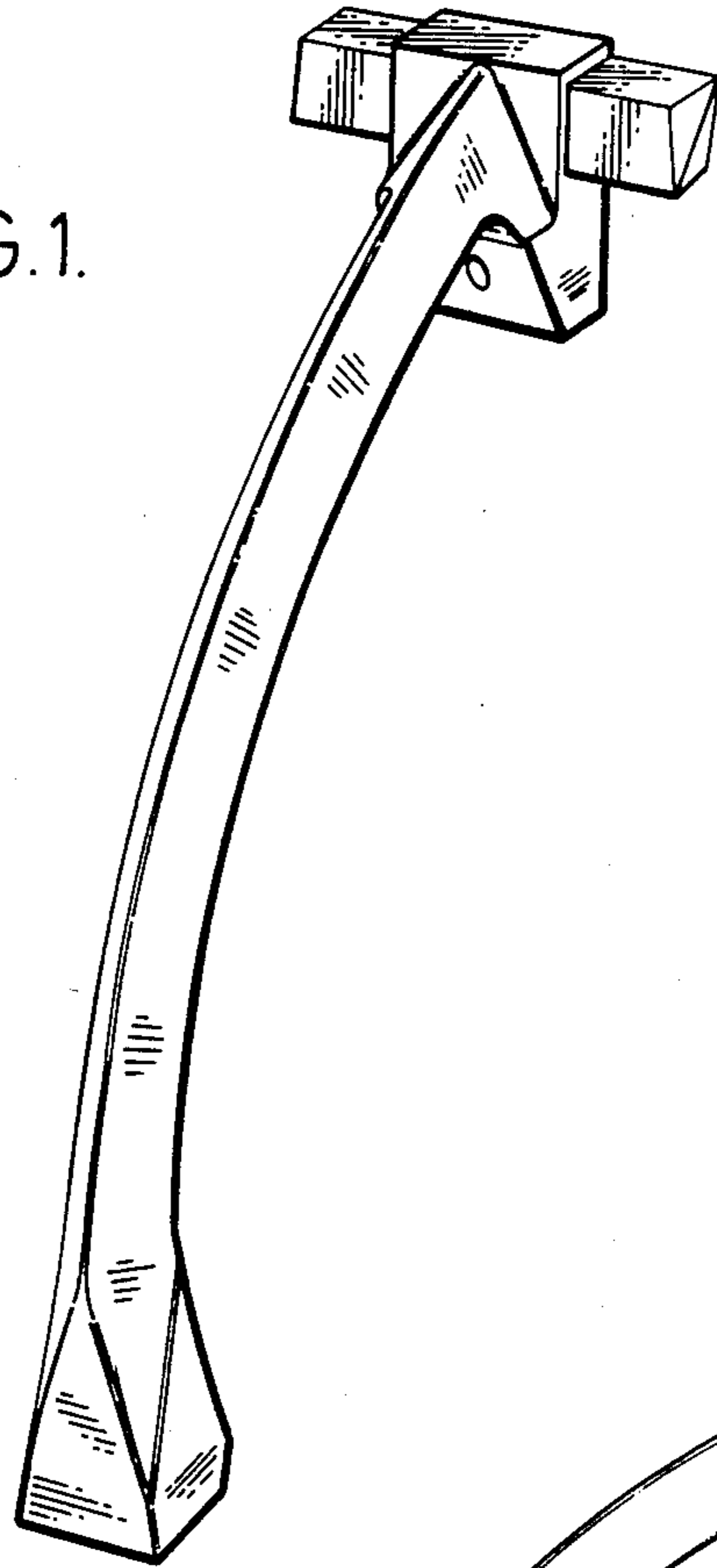
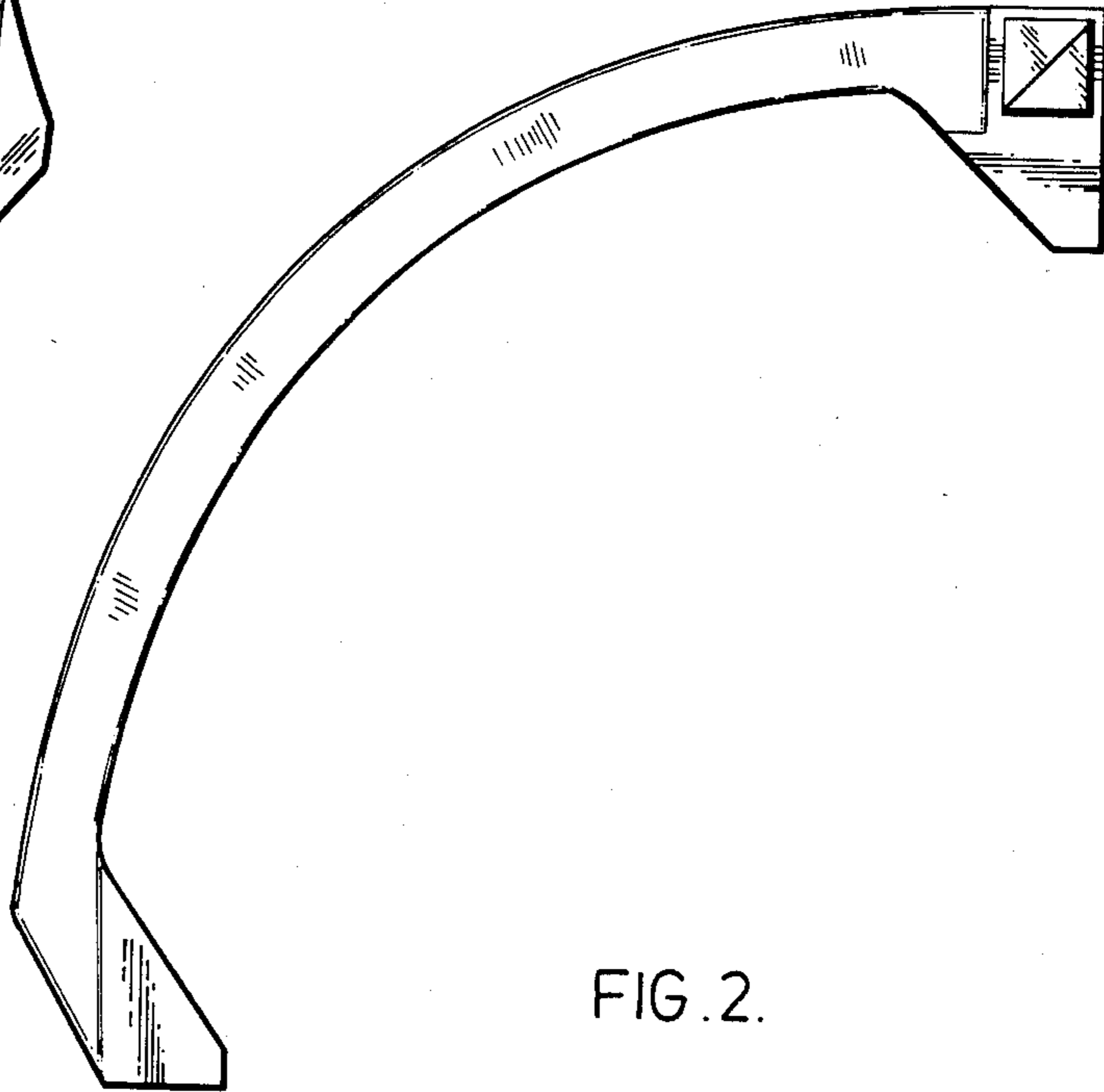

FIG. 2.



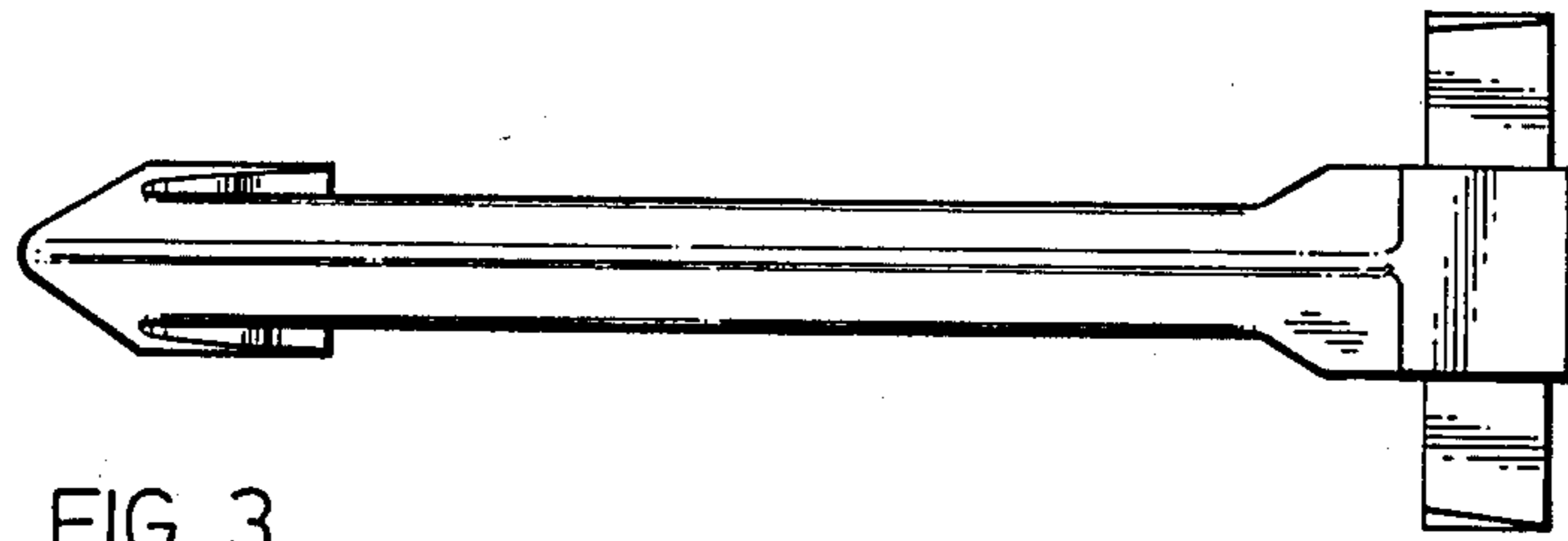

FIG. 3.

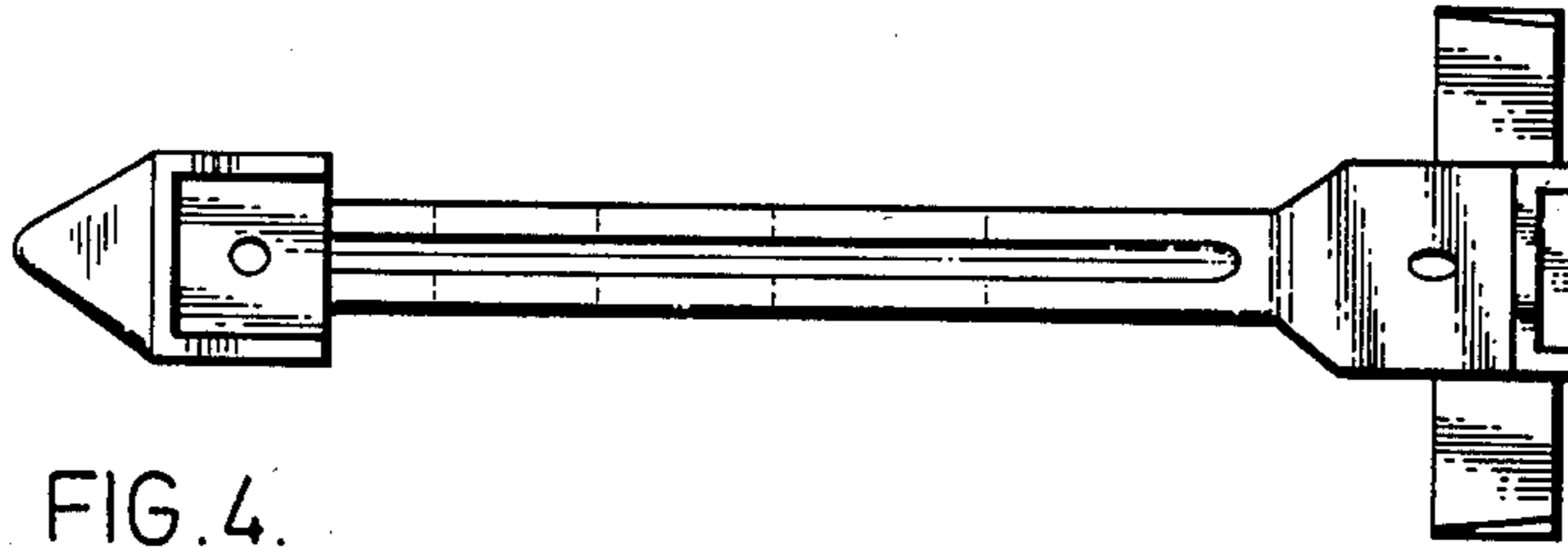

FIG. 4.

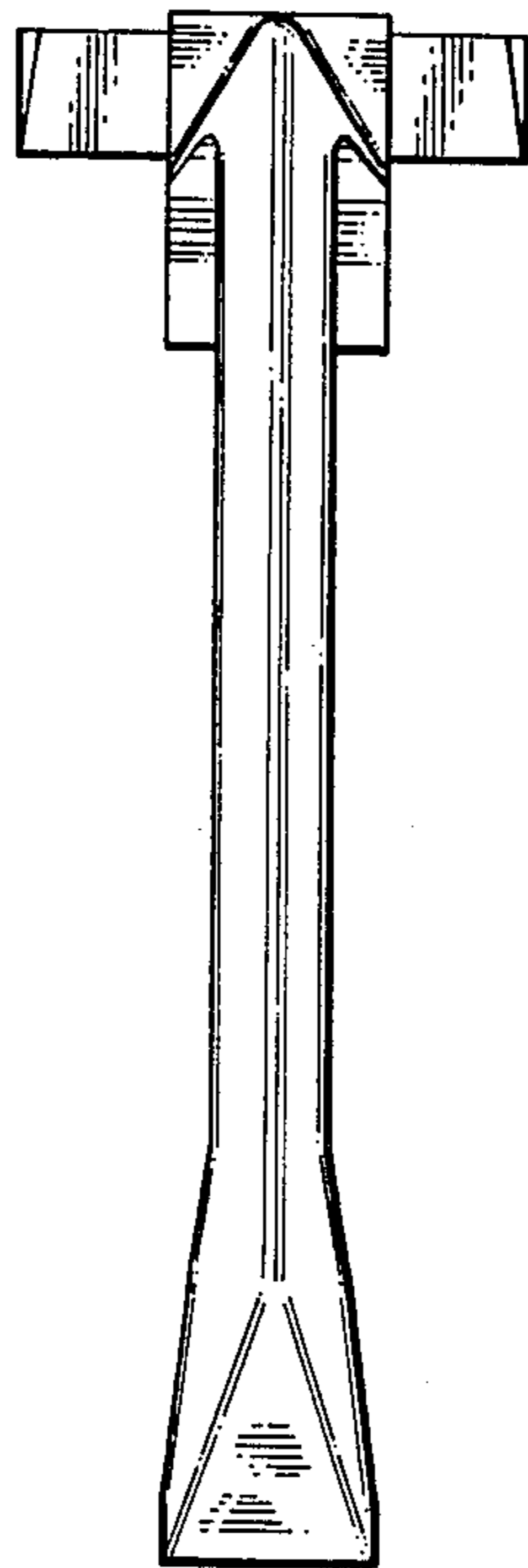

FIG. 5.

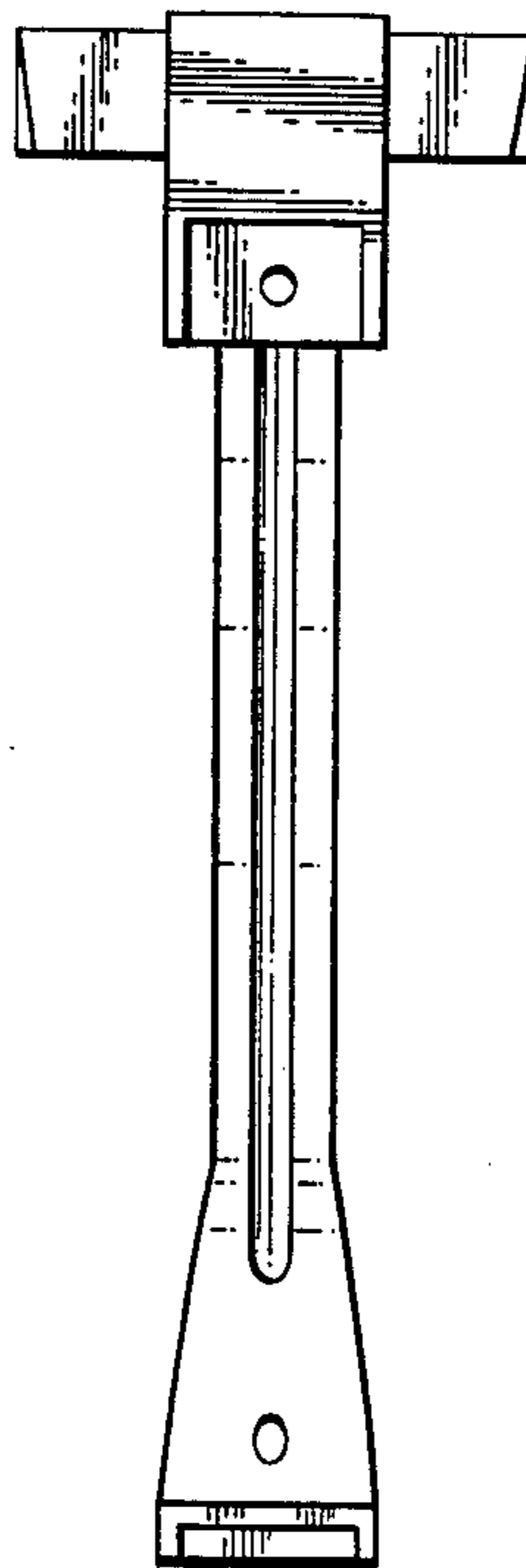

FIG. 6.