

United States Patent [19]

Tsuruoka

[11] Patent Number: Des. 299,494

[45] Date of Patent: ** Jan. 24, 1989

[54] TELEPHONE EQUIPPED FACSIMILE

[75] Inventor: Hideo Tsuruoka, Chiba, Japan

[73] Assignee: Tokyo Electric Co., Ltd., Tokyo, Japan

[**] Term: 14 Years

[21] Appl. No.: 925,878

[22] Filed: Oct. 31, 1986

[30] Foreign Application Priority Data

May 6, 1986 [JP] Japan 61-16503

[52] U.S. Cl. D14/118; D14/151

[58] Field of Search D14/94, 99, 52, 63; D16/27, 30, 31, 32; 358/256, 286

[56] References Cited

U.S. PATENT DOCUMENTS

D. 218,170 7/1970 Kober D14/94
D. 292,976 12/1987 Kando D14/94
D. 293,240 12/1987 Hashimoto D14/94

D. 293,574 1/1988 Kando et al. D14/94
D. 294,022 2/1988 Sekiguchi et al. D14/63 X
D. 296,437 1/1988 Martinez D14/63 X

Primary Examiner—Bernard Ansher
Assistant Examiner—Theodore M. Shooman
Attorney, Agent, or Firm—Bacon & Thomas

[57] CLAIM

The ornamental design for a telephone equipped facsimile, as shown and described.

DESCRIPTION

FIG. 1 is a top and left side perspective view of a telephone equipped facsimile showing my new design; FIG. 2 is a top plan view thereof with the telephone handset taken off; FIG. 3 is a front elevational view thereof; FIG. 4 is a top plan view thereof; FIG. 5 is a right side elevational view thereof; FIG. 6 is a left side elevational view thereof; FIG. 7 is a rear elevational view thereof; and FIG. 8 is a bottom plan view thereof.

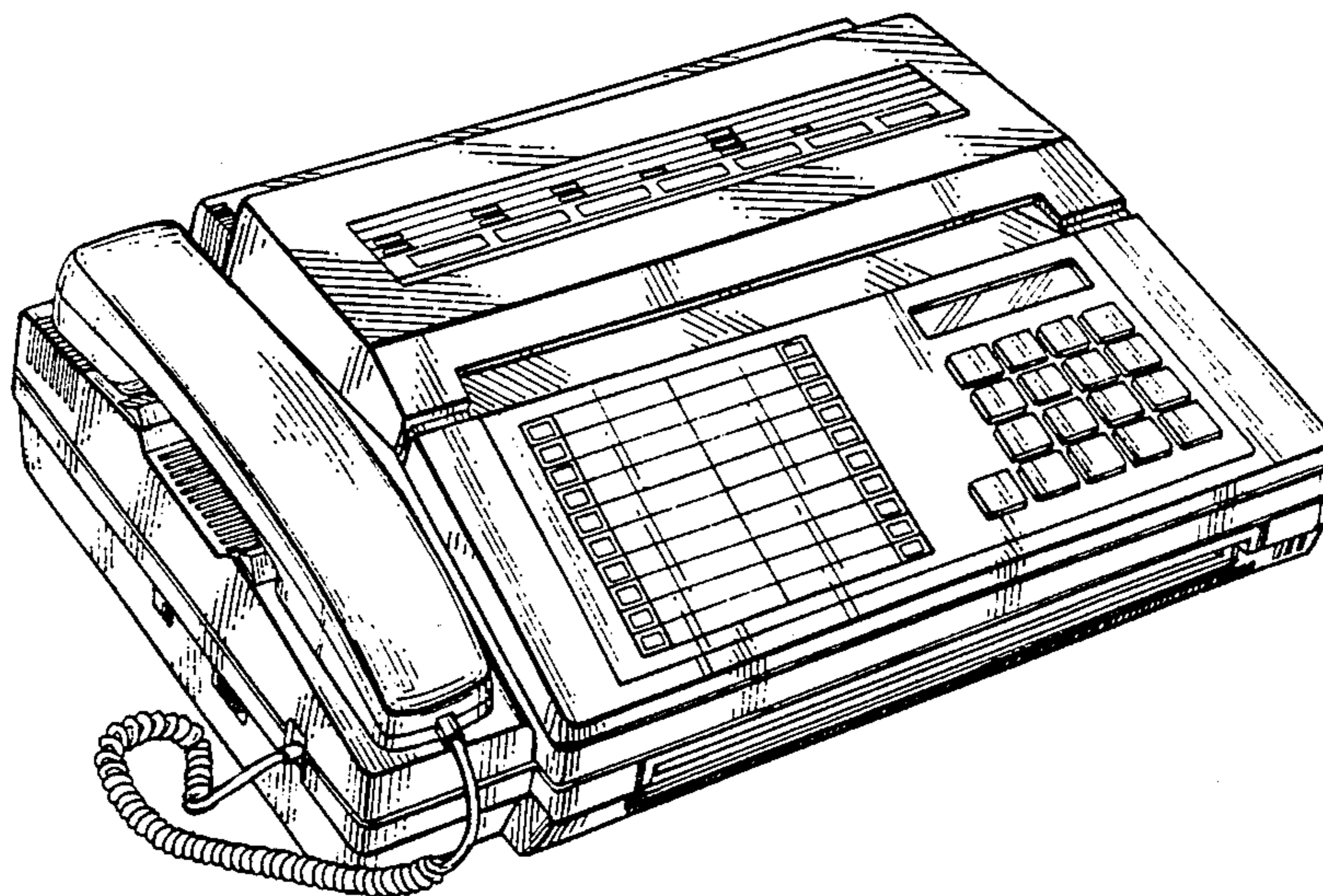

FIG. 1

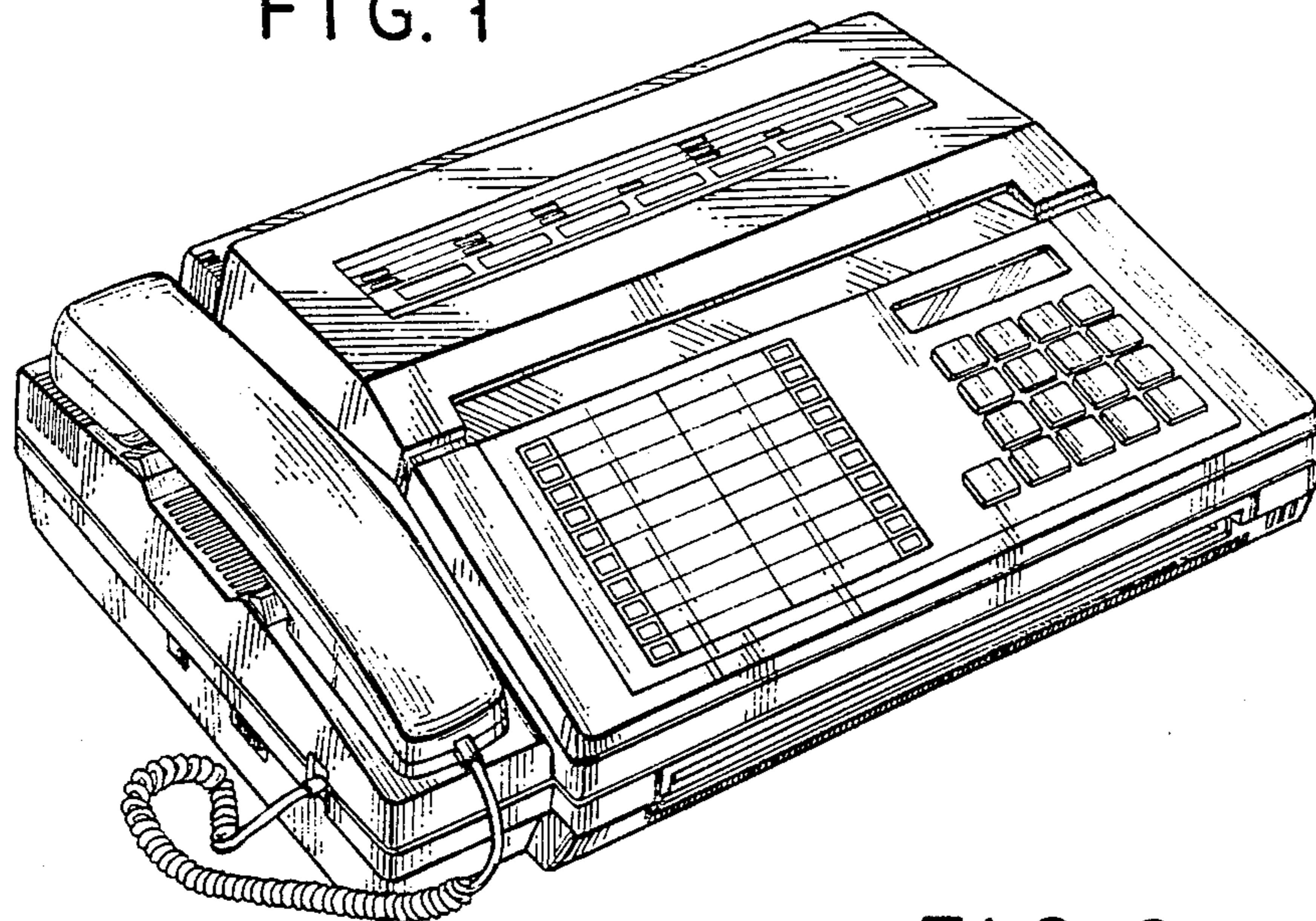

FIG. 2

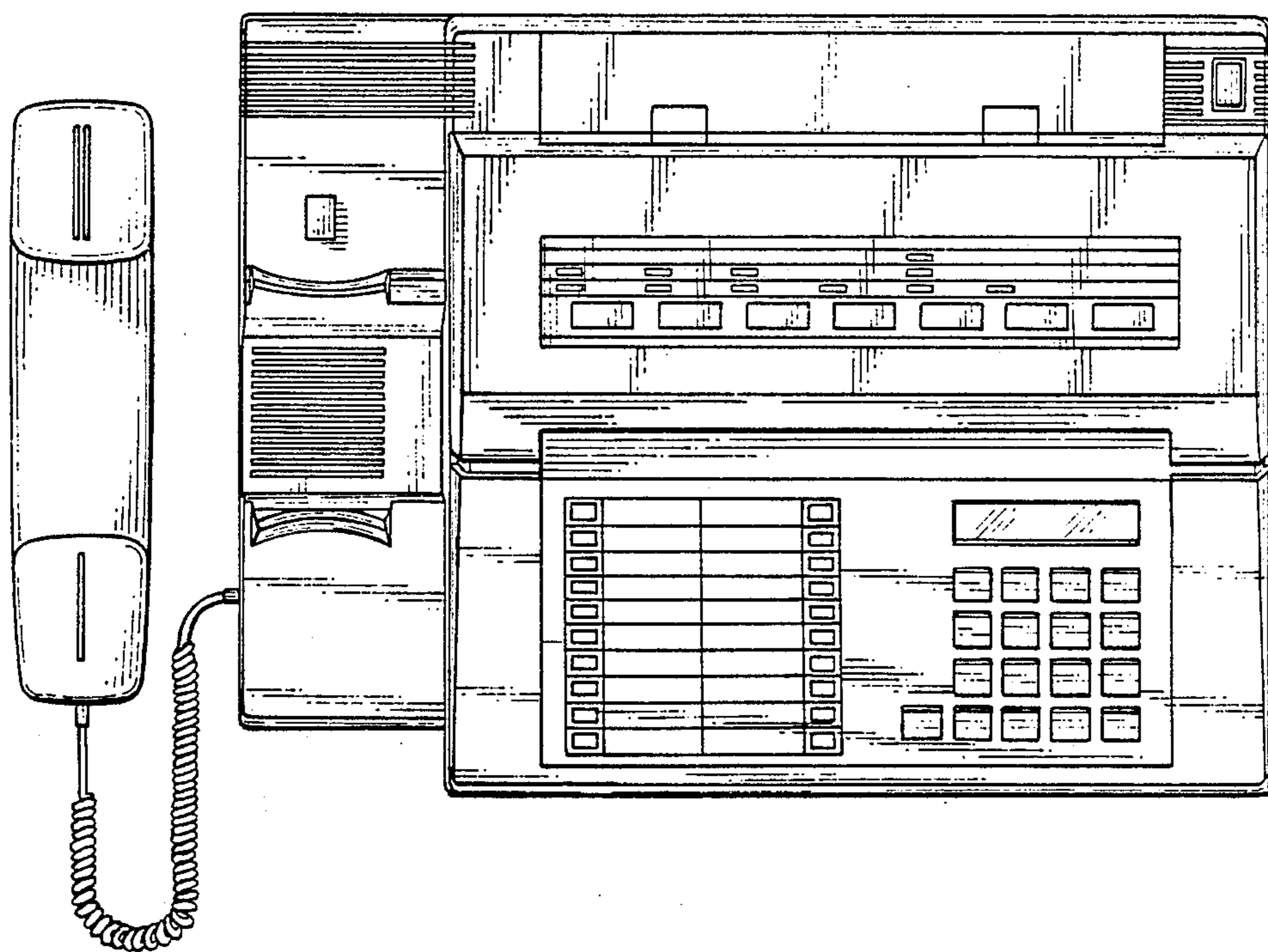

FIG. 3

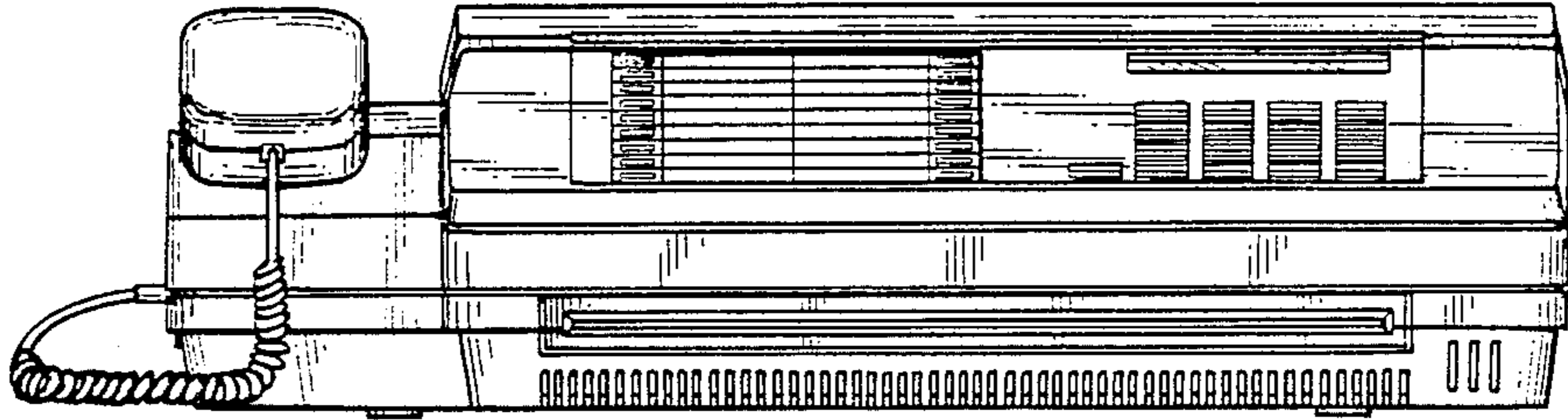

FIG. 4

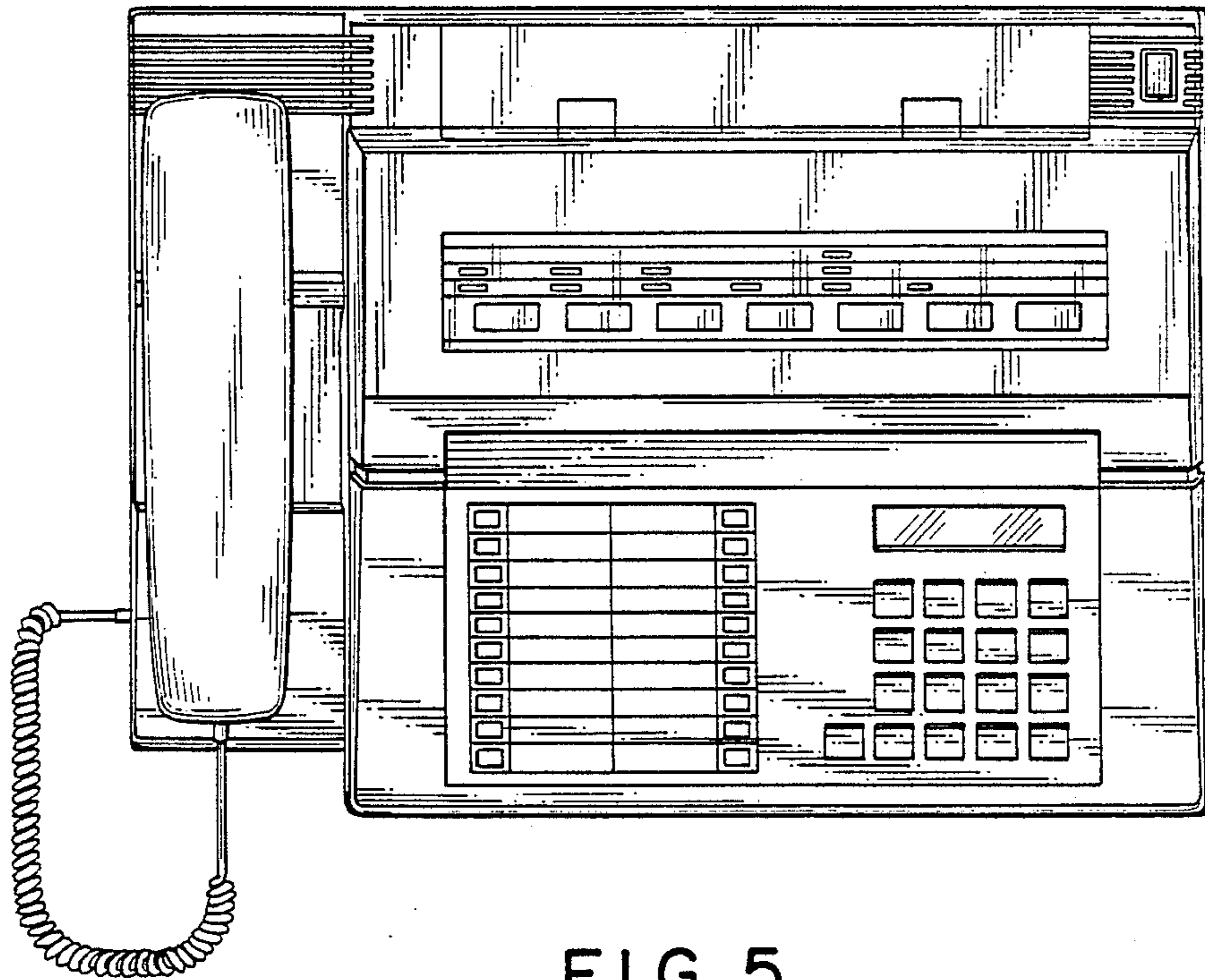

FIG. 5

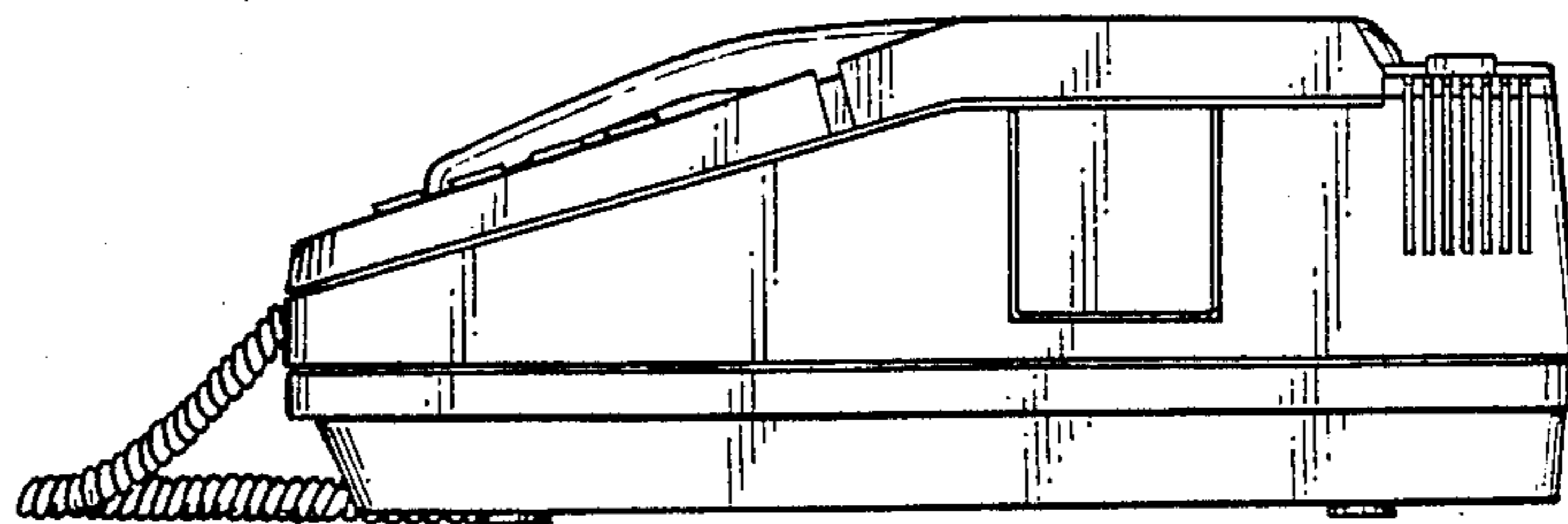

FIG. 6

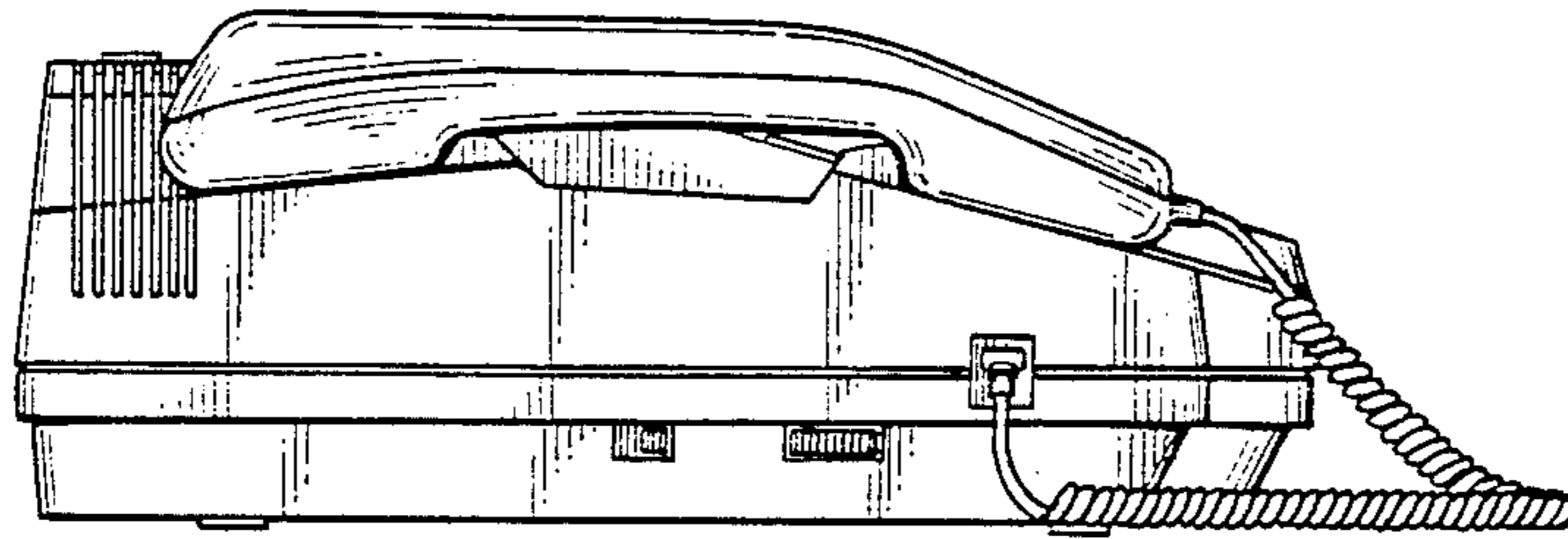

FIG. 7

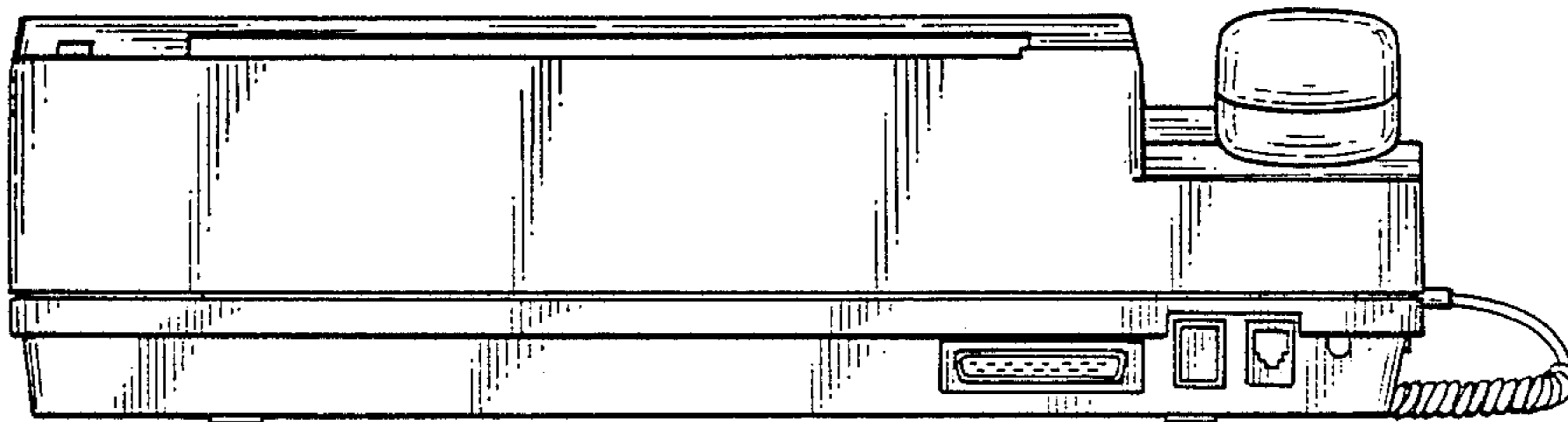

FIG. 8

