

[54] ARTHRITIC TOOTHBRUSH

[76] Inventor: Melissa N. Jacobs, 4807 Marlborough Way, Carmichael, Calif. 95608

[\*\*] Term: 14 Years

[21] Appl. No.: 841,365

[22] Filed: Mar. 3, 1986

[52] U.S. Cl. .... D4/104; D4/110; D4/129

[58] Field of Search ..... D4/100, 114, 127, 128, D4/129, 134, 135, 136; D24/10; 15/106, 107, 111, 143 R, 167.1, 167.3

[56] References Cited

U.S. PATENT DOCUMENTS

D. 27,010	5/1897	Mason	.....	D4/129
D. 41,931	11/1911	Norton	.....	D4/129
D. 58,445	7/1921	Marcellus	.....	D4/112
D. 118,155	12/1939	Bosak	.....	D4/104
1,257,883	2/1918	Kone	.....	15/167.1
1,517,320	12/1924	Stoddart	.....	15/22 R
2,645,801	7/1953	Seidner	.....	15/143 R
4,457,039	7/1984	Massari	.....	15/167.1
4,654,921	4/1987	Dinner	.....	D4/110

Primary Examiner—Lucas Susan J.  
Attorney, Agent, or Firm—Mark C. Jacobs

[57] CLAIM

The ornamental design for arthritic toothbrush, as shown and described.

DESCRIPTION

FIG. 1 is a top plan view of a arthritic toothbrush showing my new design;  
 FIG. 2 is a front elevational view thereof;  
 FIG. 3 is a left side elevation view thereof;  
 FIG. 4 is a right side elevational view thereof;  
 FIG. 5 is a bottom plan view thereof;  
 FIG. 6 is a top plan view of the send embodiment of the arthritic toothbrush;  
 FIG. 7 is a front elevational view thereof;  
 FIG. 8 is a left side elevational view thereof;  
 FIG. 9 is a rear elevational view thereof;  
 FIG. 10 is a bottom plan view thereof;  
 FIG. 11 is a front elevational view of a third embodiment of my new design;  
 FIG. 12 is a top plan view thereof;  
 FIG. 13 is a right side elevational view thereof;  
 FIG. 14 is a bottom plan view thereof; and  
 FIG. 15 is a rear elevational view thereof.  
 The bristle are shown in broken lines for illustrative purpose only.

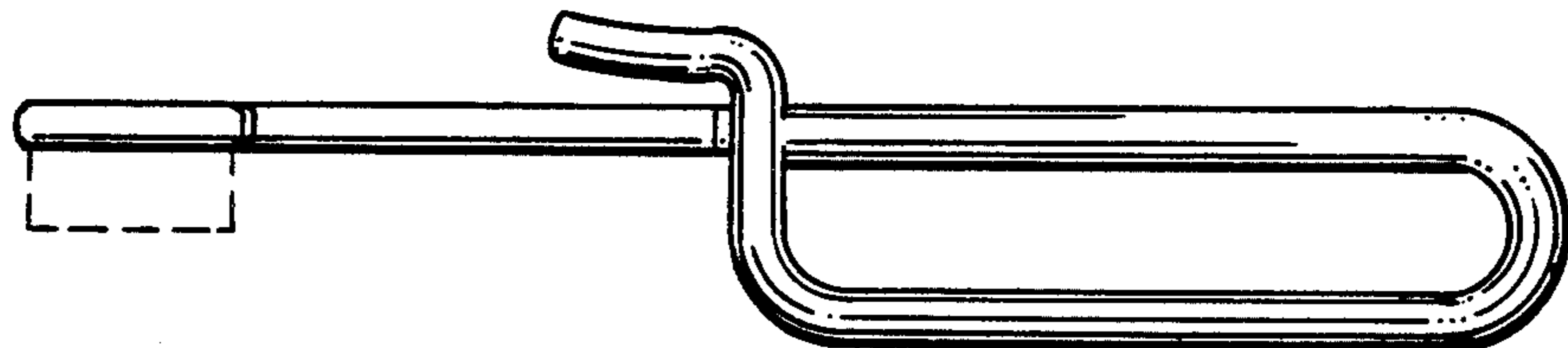



FIG. 1

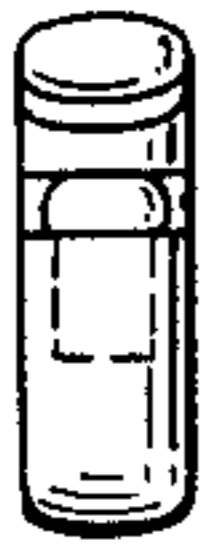

FIG. 2

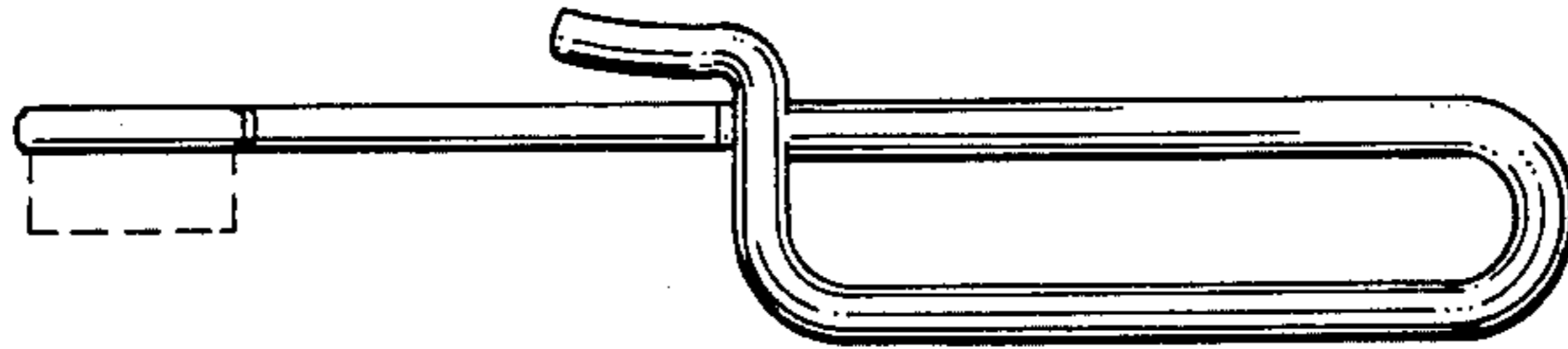

FIG. 3



FIG. 4



FIG. 5

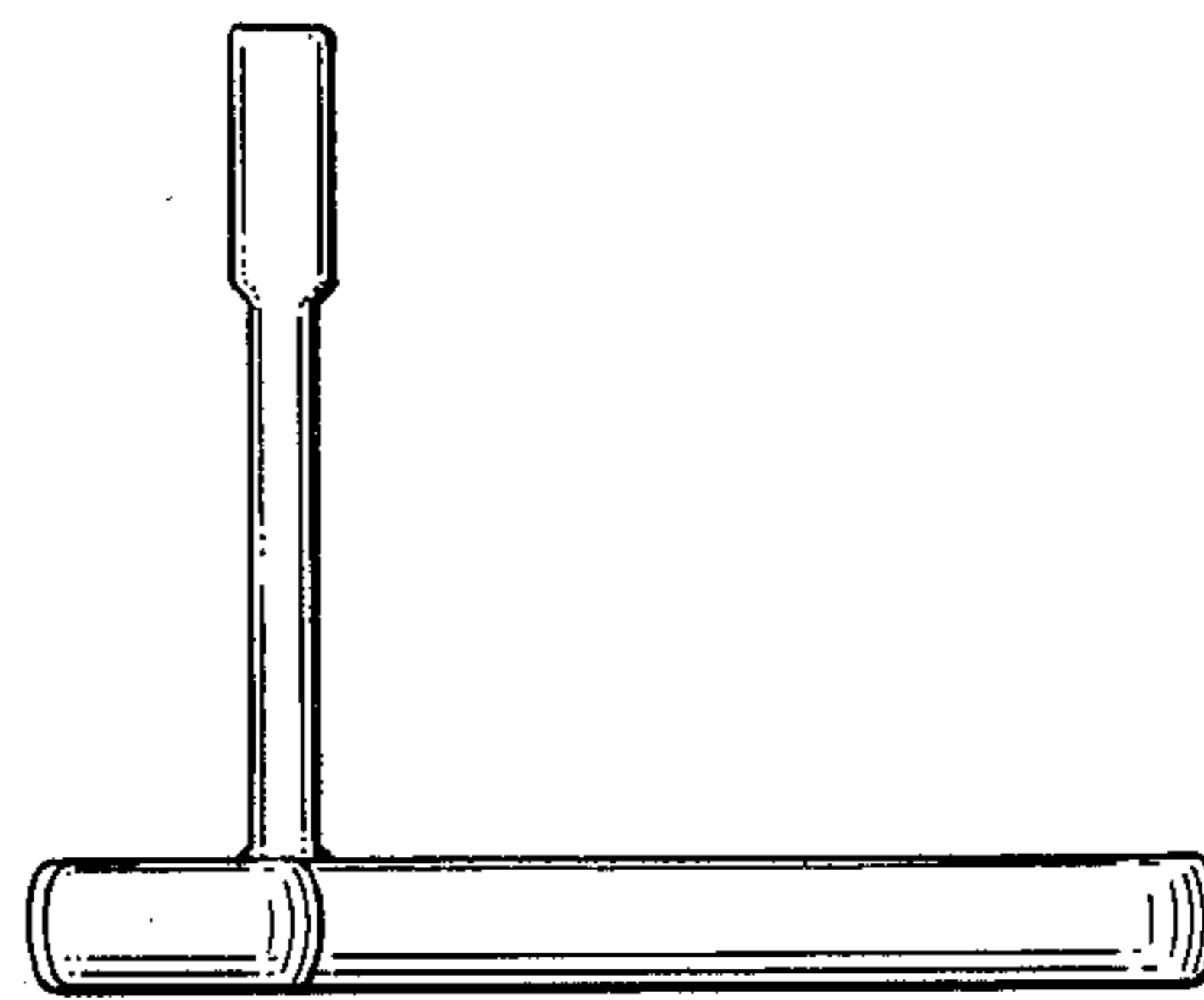

FIG. 6

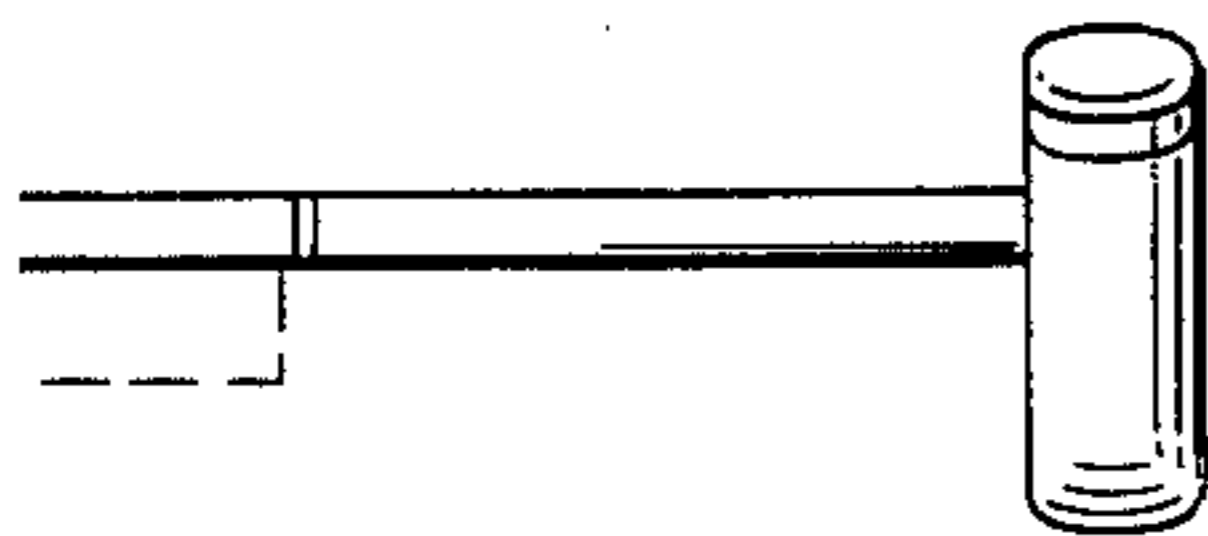

FIG. 7

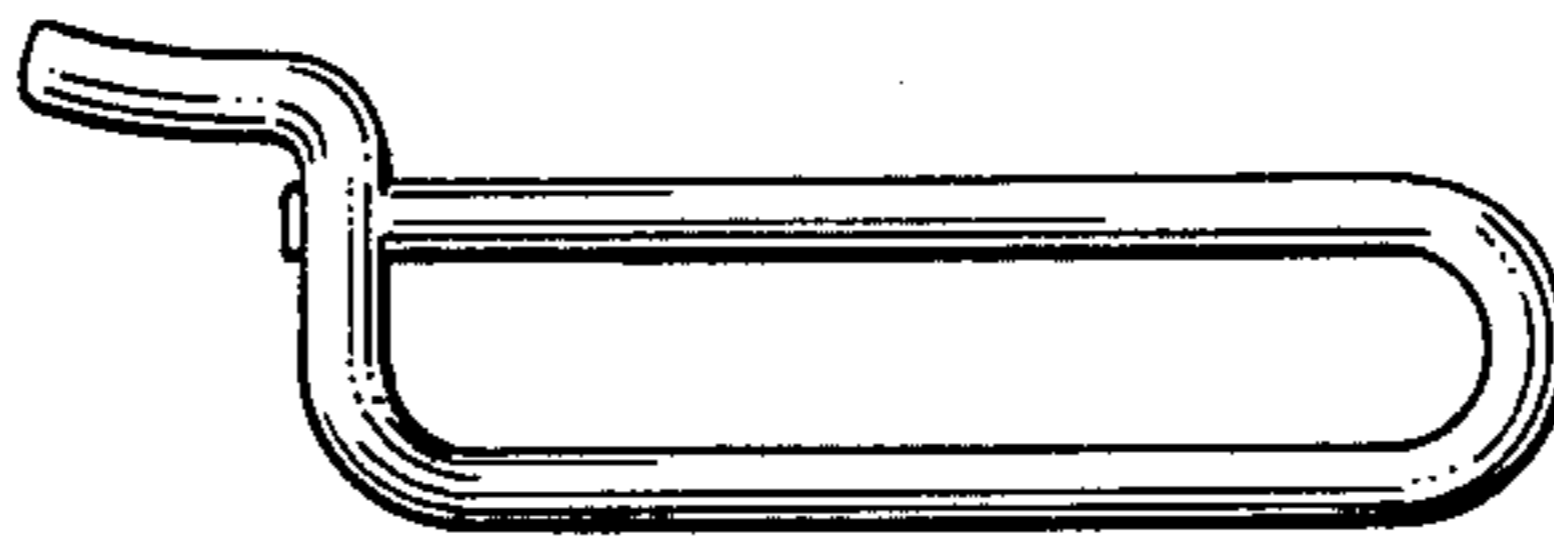

FIG. 8

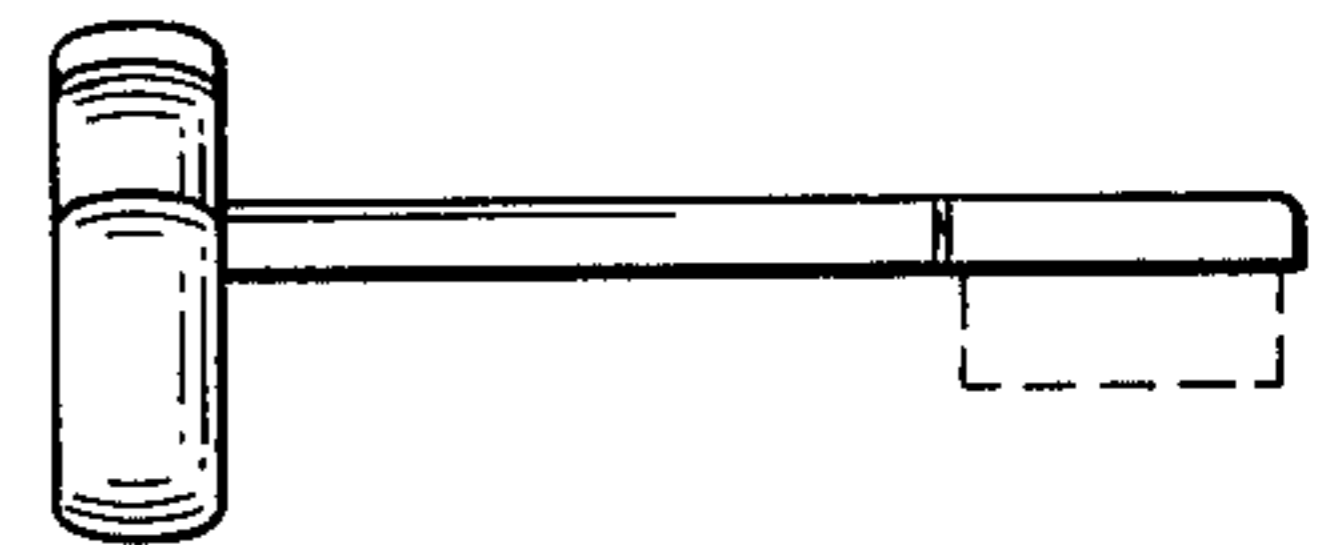

FIG. 9

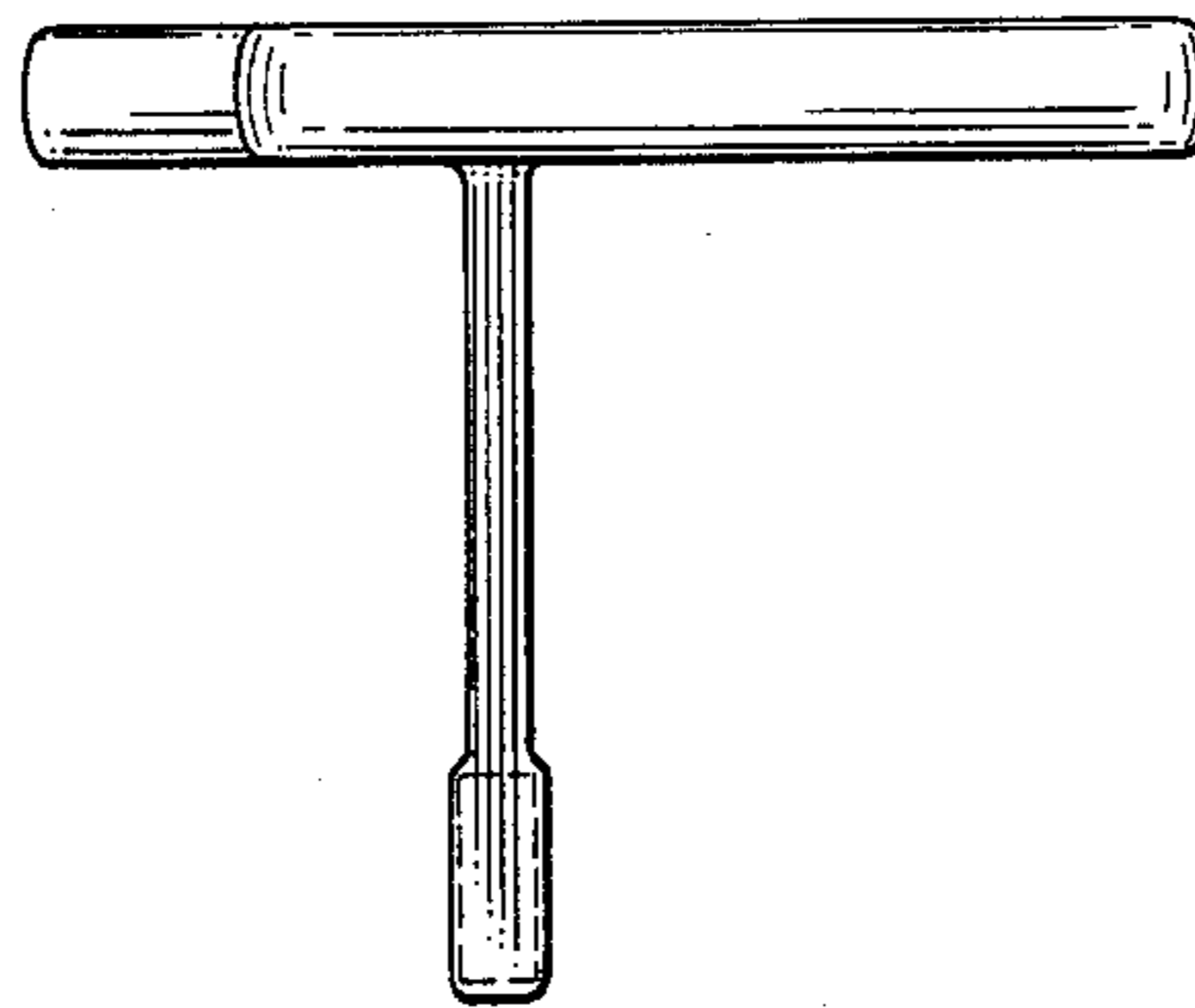

FIG. 10

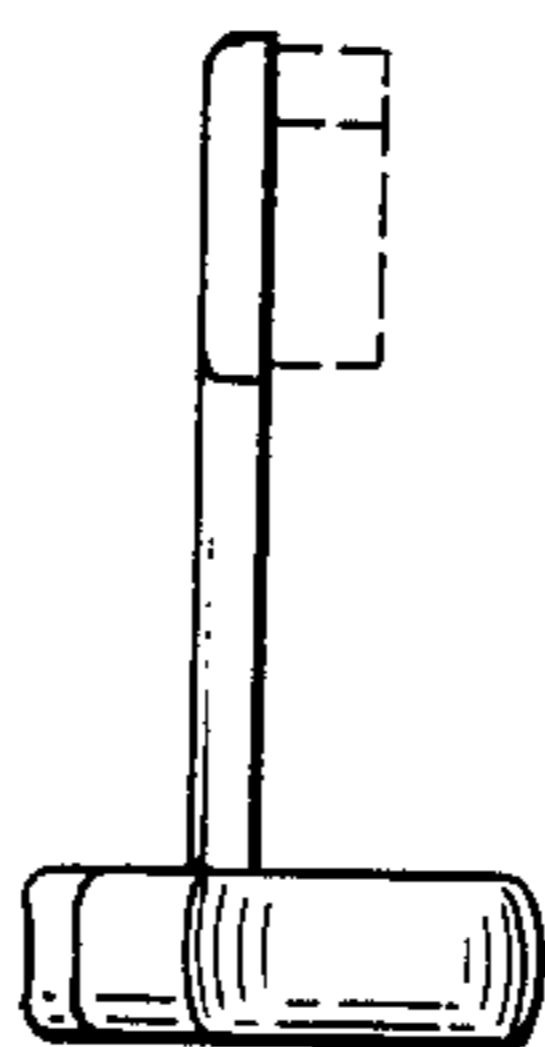
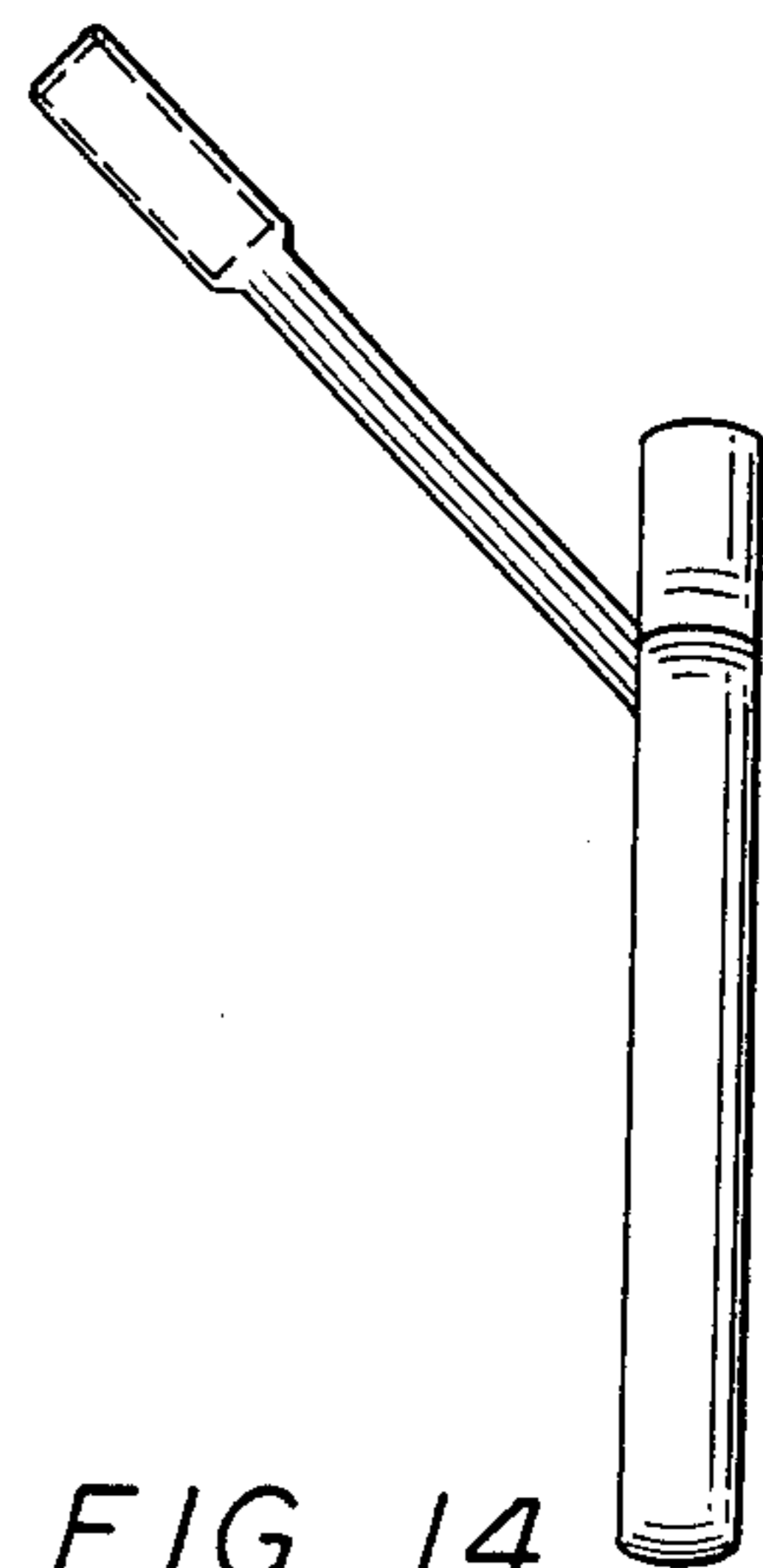
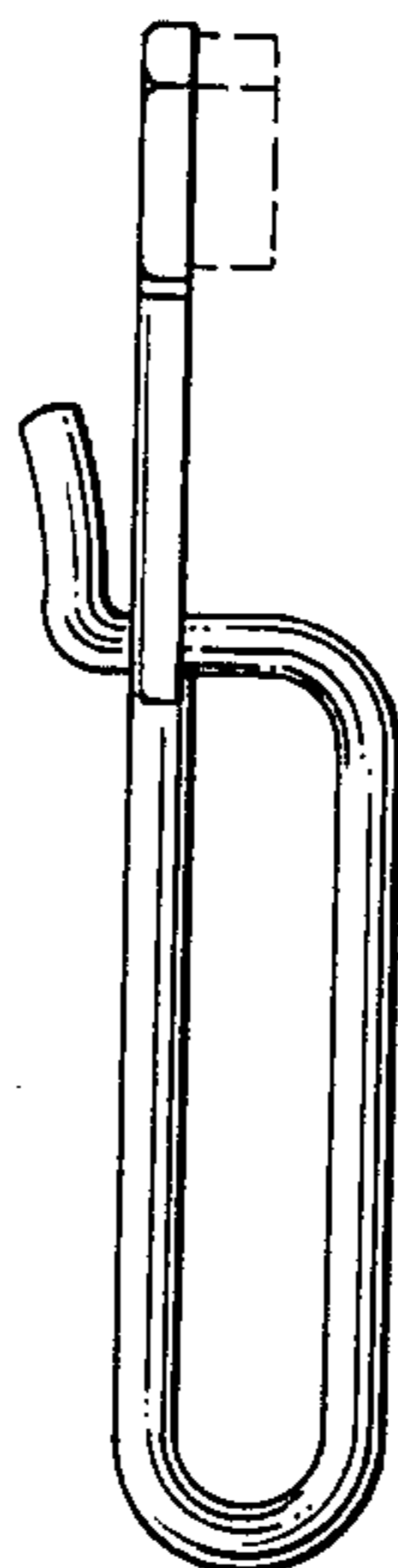
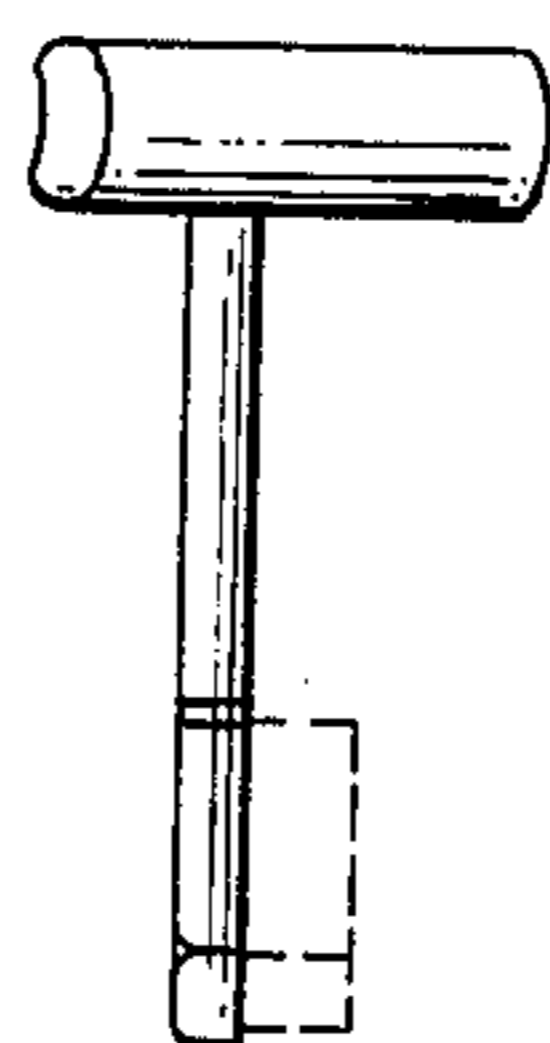
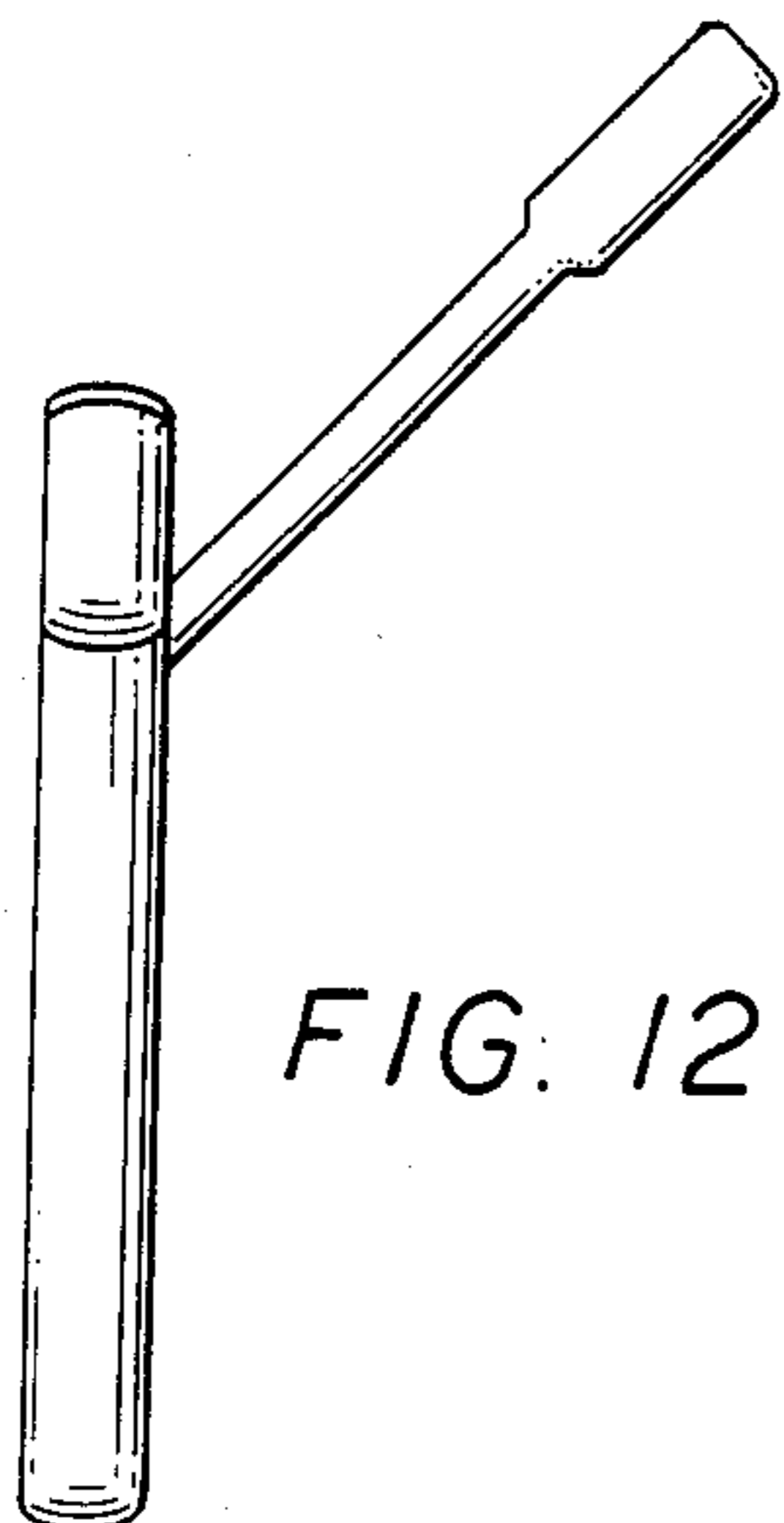

FIG. 15