

**United States Patent** [19]  
**Kasanda**

[11] **Patent Number: Des. 299,315**  
[45] **Date of Patent: \*\* Jan. 10, 1989**

- [54] **PACKAGING CONTAINER**
- [75] **Inventor: Thomas J. Kasanda, Ottawa, Canada**
- [73] **Assignee: Keepsakes Time Capsules, Inc., Ottawa, Canada**
- [\*\*] **Term: 14 Years**
- [21] **Appl. No.: 766,789**
- [22] **Filed: Aug. 19, 1985**
- [30] **Foreign Application Priority Data**  
Jun. 19, 1985 [CA] Canada ..... 19-06-85-6
- [52] **U.S. Cl. .... D9/398**
- [58] **Field of Search ..... D9/424, 349, 350, 352, D9/351, 390, 398, 399; 220/1 R; 229/93**
- [56] **References Cited**  
**U.S. PATENT DOCUMENTS**  
D. 96,089 7/1935 Botham ..... D9/398  
D. 103,387 3/1937 Chesler ..... D9/424

- D. 260,843 9/1981 Laird et al. .... D9/399 X  
D. 267,702 1/1983 Swann ..... D9/424  
D. 278,600 4/1985 Fortuna ..... D9/399

*Primary Examiner*—Nelson C. Holtje  
*Attorney, Agent, or Firm*—Laubscher & Laubscher

[57] **CLAIM**

The ornamental design for a packaging container, as shown and described.

**DESCRIPTION**

FIG. 1 is a perspective view of a packaging container showing my new design;  
FIG. 2 is a front view of the design shown in FIG. 1, rotated 45° about the longitudinal axis of the container;  
FIG. 3 is the rear view thereof;  
FIG. 4 is the top view thereof;  
FIG. 5 is the bottom view thereof;  
FIG. 6 is the end view of the design shown in FIG. 2 taken from the left;  
FIG. 7 is the end view of the design shown in FIG. 2 taken from the right.

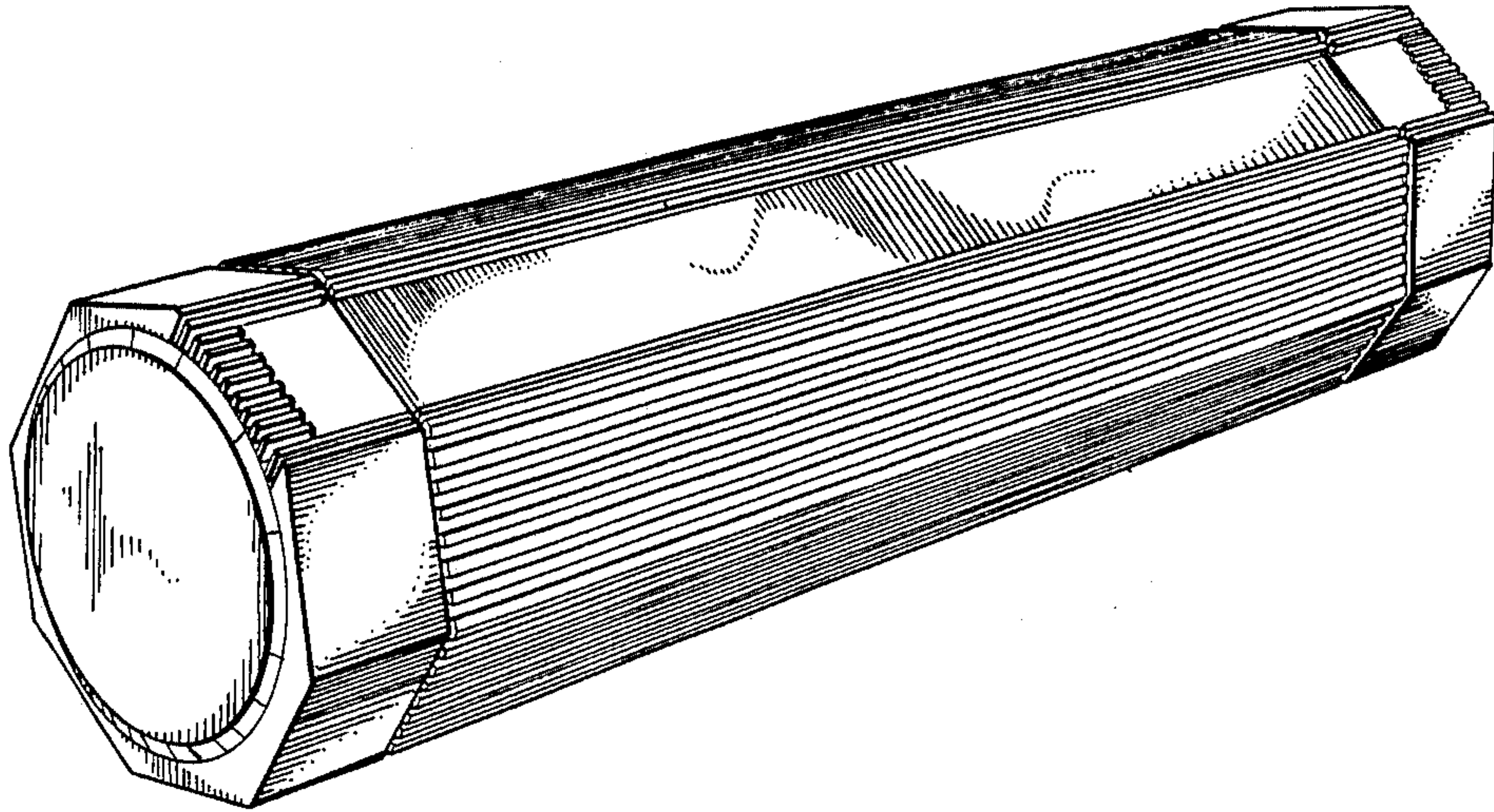

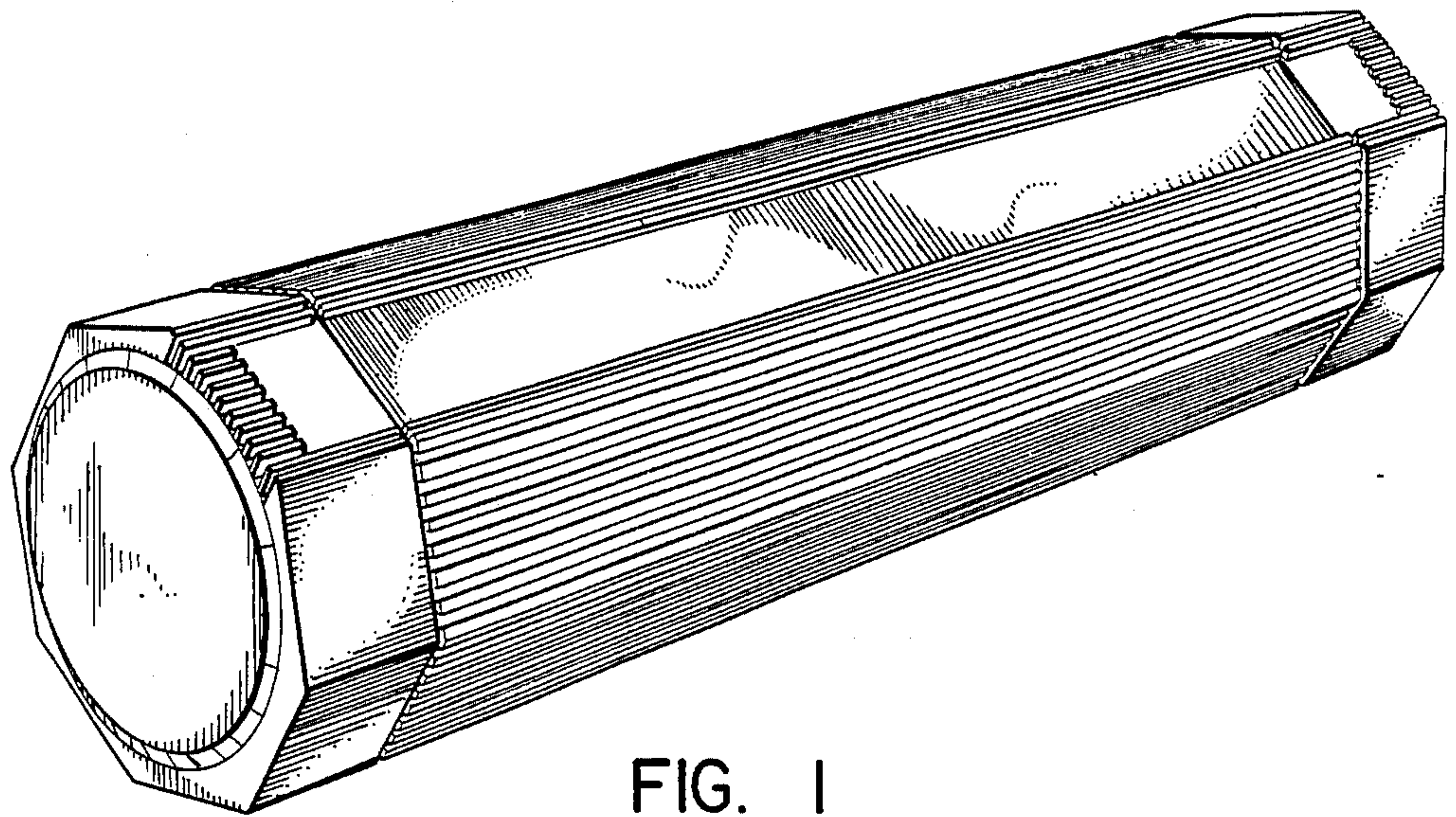

FIG. 1

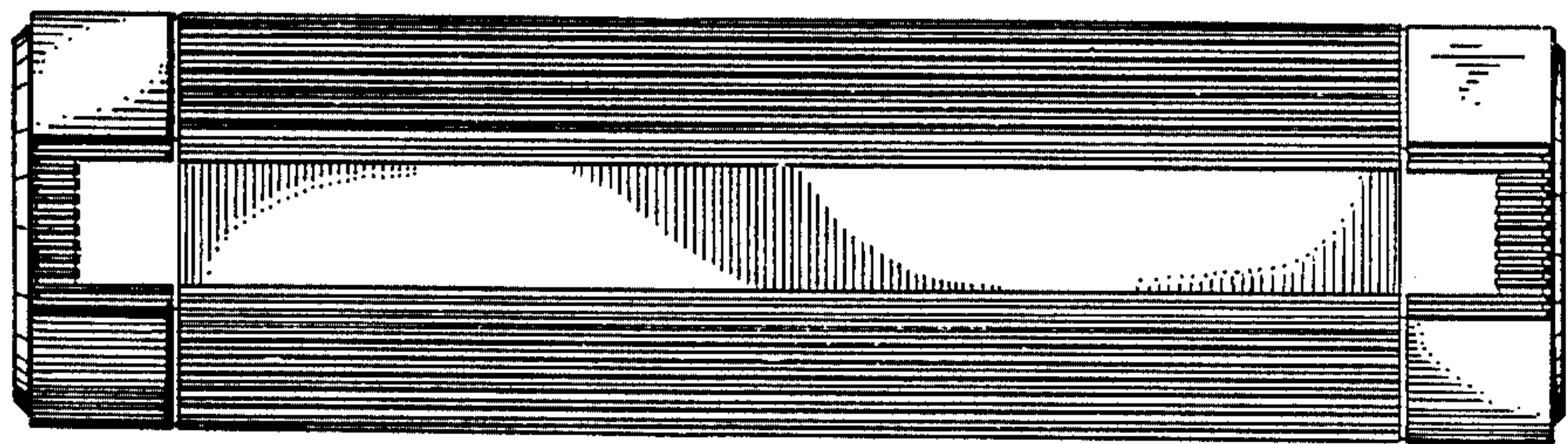

FIG. 2

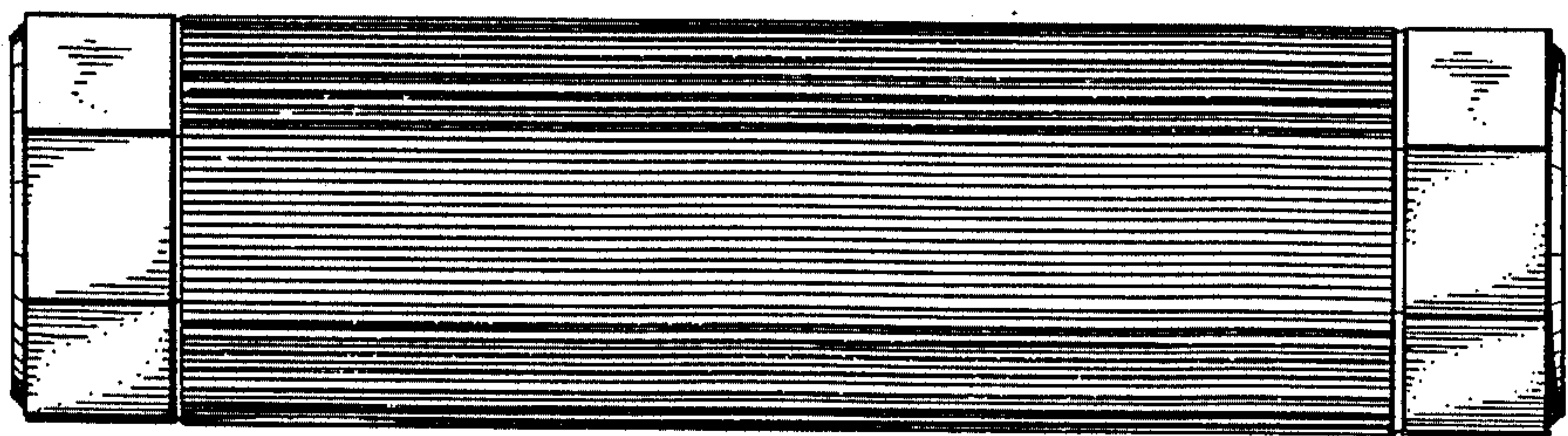

FIG. 3



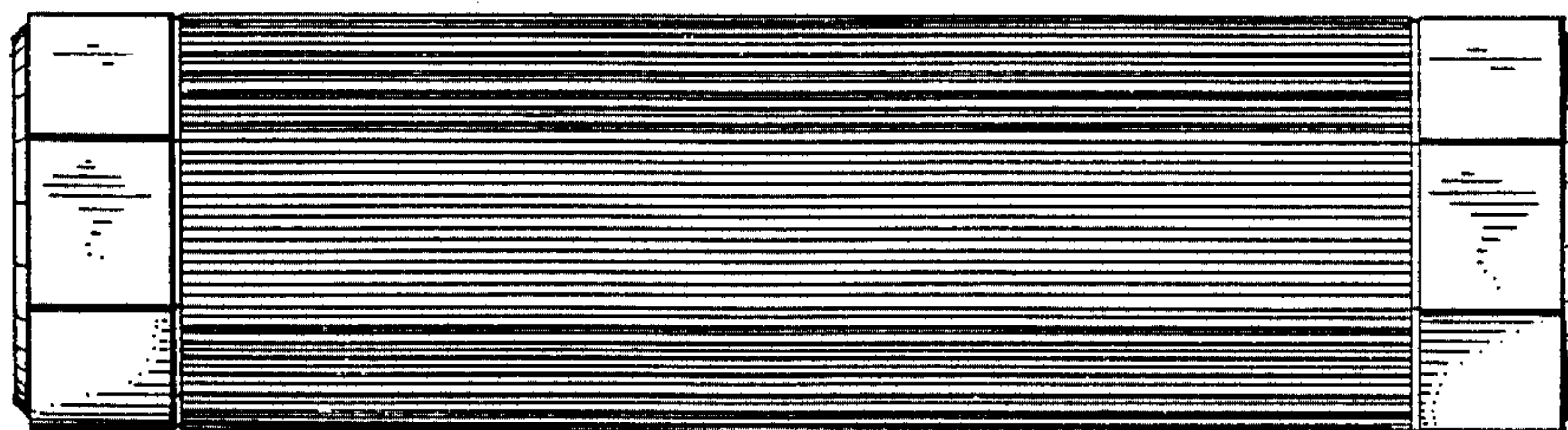

FIG. 4

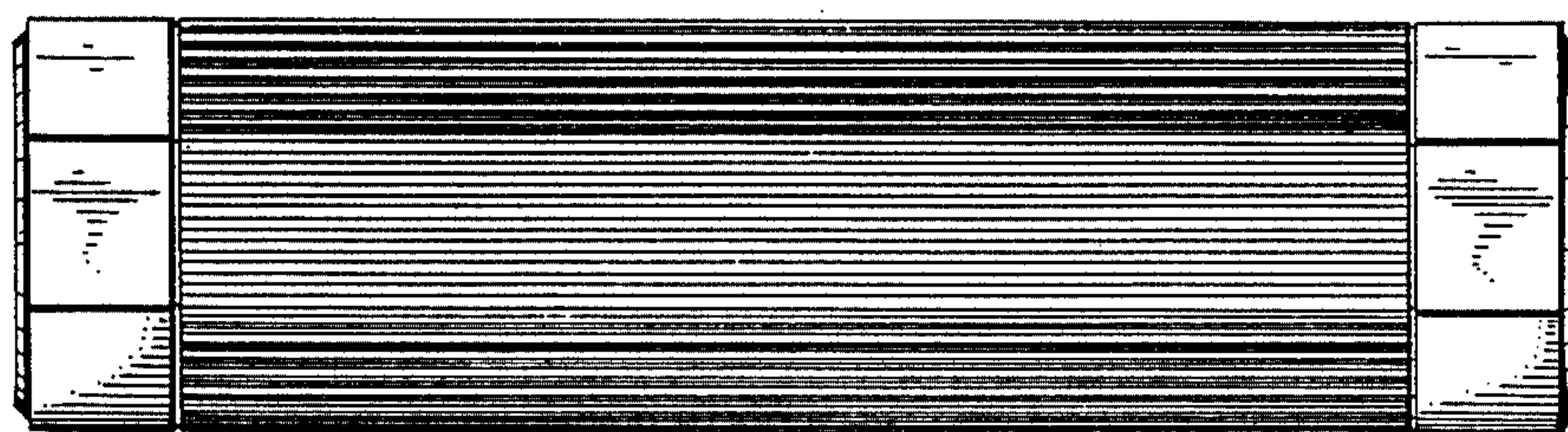

FIG. 5

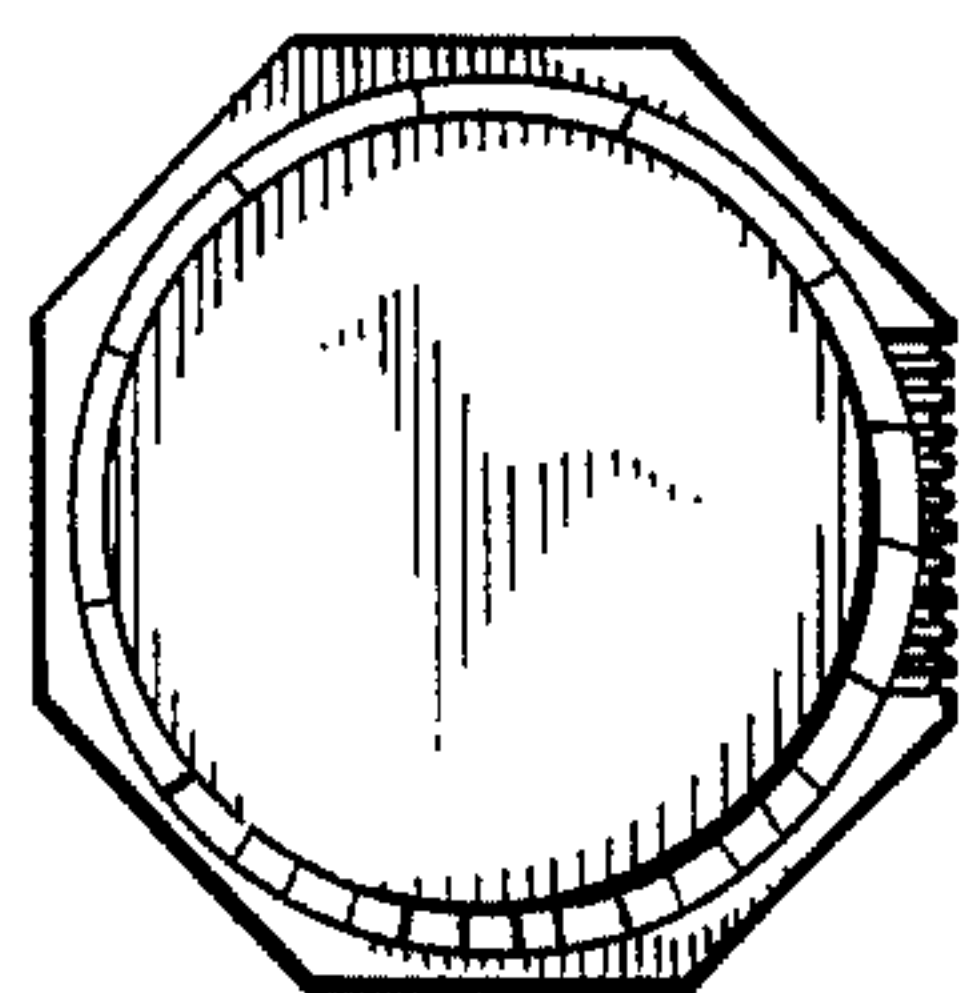

FIG. 6

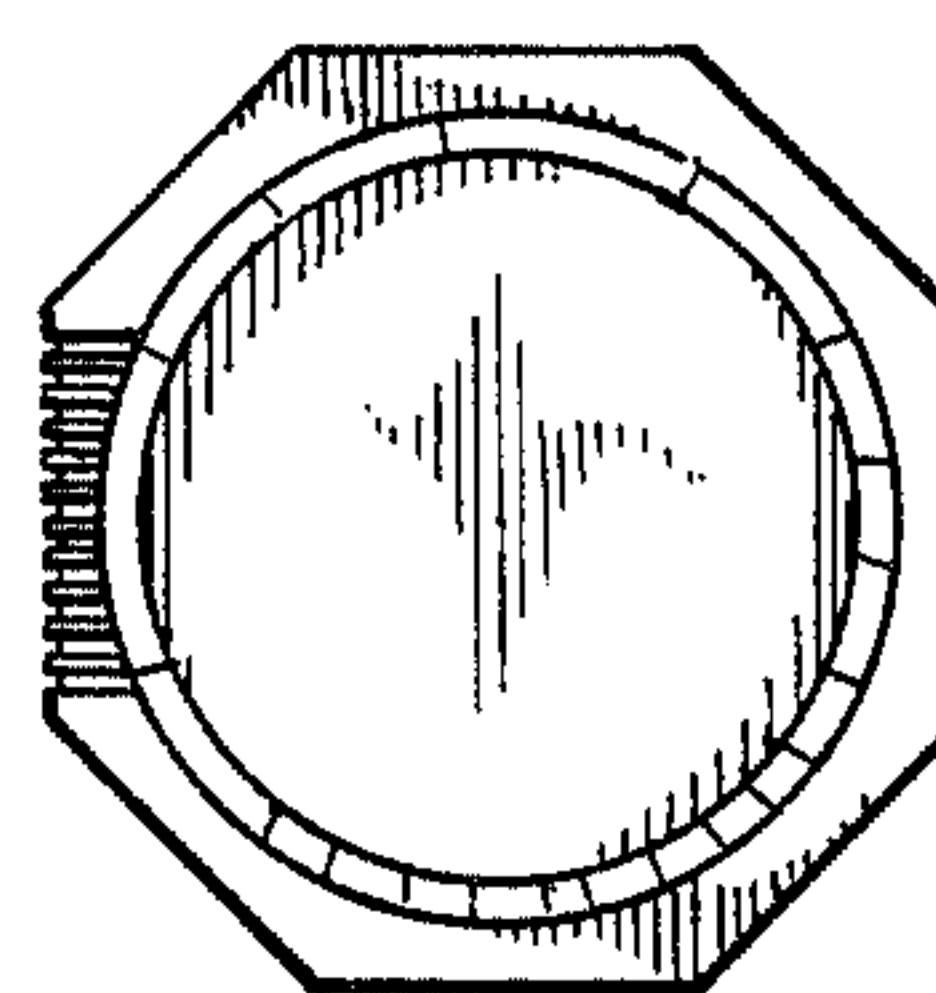

FIG. 7