

[54] HAIR BRUSH

[75] Inventors: Kevin E. Reeves, Trumbull; John C. Wistrand, New Canaan, both of Conn.

[73] Assignee: Clairol Incorporated, New York, N.Y.

[\*\*] Term: 14 Years

[21] Appl. No.: 918,956

[22] Filed: Oct. 15, 1986

[52] U.S. Cl. .... D28/35; D4/128; D4/133

[58] Field of Search ..... D4/127-128, D4/130-136, 138; 15/159 R, 186-188, 160; D28/35

[56] References Cited

U.S. PATENT DOCUMENTS

- D. 270,381 8/1983 Muller et al. .... D28/13
- D. 281,105 10/1985 Rittenhouse ..... D28/35
- D. 281,728 12/1985 Sherman ..... D28/35
- 4,486,915 12/1984 Stewart et al. .... 15/187

FOREIGN PATENT DOCUMENTS

- 2172201 9/1986 United Kingdom ..... 15/160

Primary Examiner—Wallace R. Burke  
Assistant Examiner—Lavone D. Tabor

Attorney, Agent, or Firm—Gene Warzecha

[57] CLAIM

The ornamental design for a hair brush, substantially as shown and described.

DESCRIPTION

FIG. 1 is a side elevational view of a hair brush showing our new design with the broken lines showing an electrical cord fragment being for illustrative purposes only and forming no part of the claimed design.

FIG. 2 is a plan view thereof, both top and bottom plan views being identical.

FIG. 3 is a front elevational view thereof.

FIG. 4 is a rear elevational view thereof.

FIG. 5 is a fragmentary side elevational side view of a modified form of the hair brush shown in FIG. 1, the only difference residing in the appearance of the handle portion.

FIG. 6 is a top plan view thereof.

FIG. 7 is a rear side elevational view thereof.

FIG. 8 is a front elevational view thereof.

FIG. 9 is a rear elevational view thereof.

FIG. 10 is a fragmentary perspective view of a further modified form of the hair brush shown in FIG. 1, the only difference residing in the appearance of the handle portion.

FIG. 11 is a rear view thereof.

FIG. 12 is a side elevational view thereof.

FIG. 13 is a plan view thereof, both top and bottom plan views being identical.

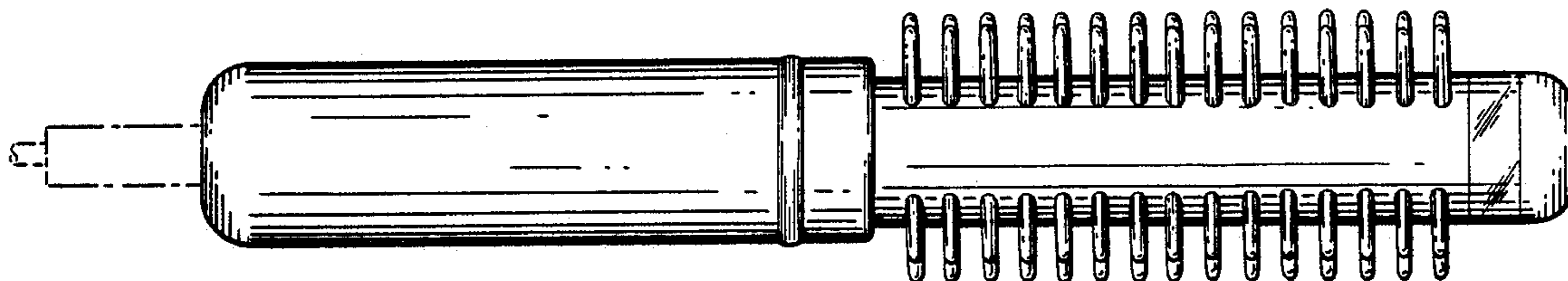

FIG. 1

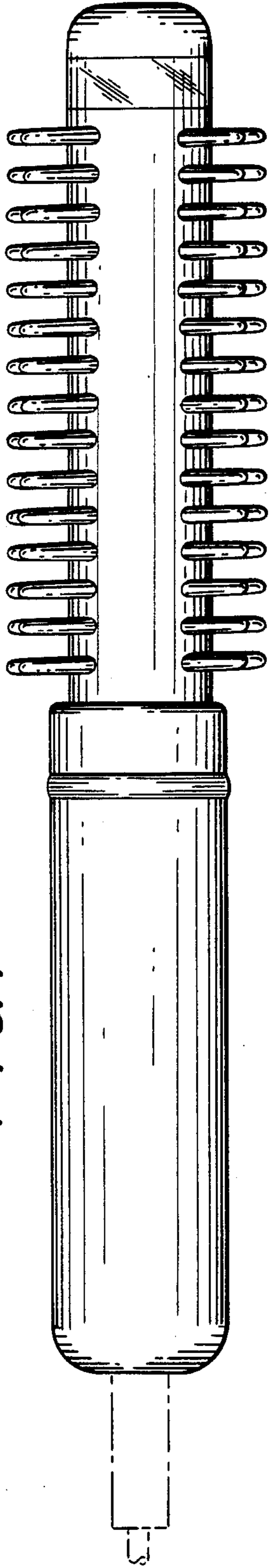

FIG. 2

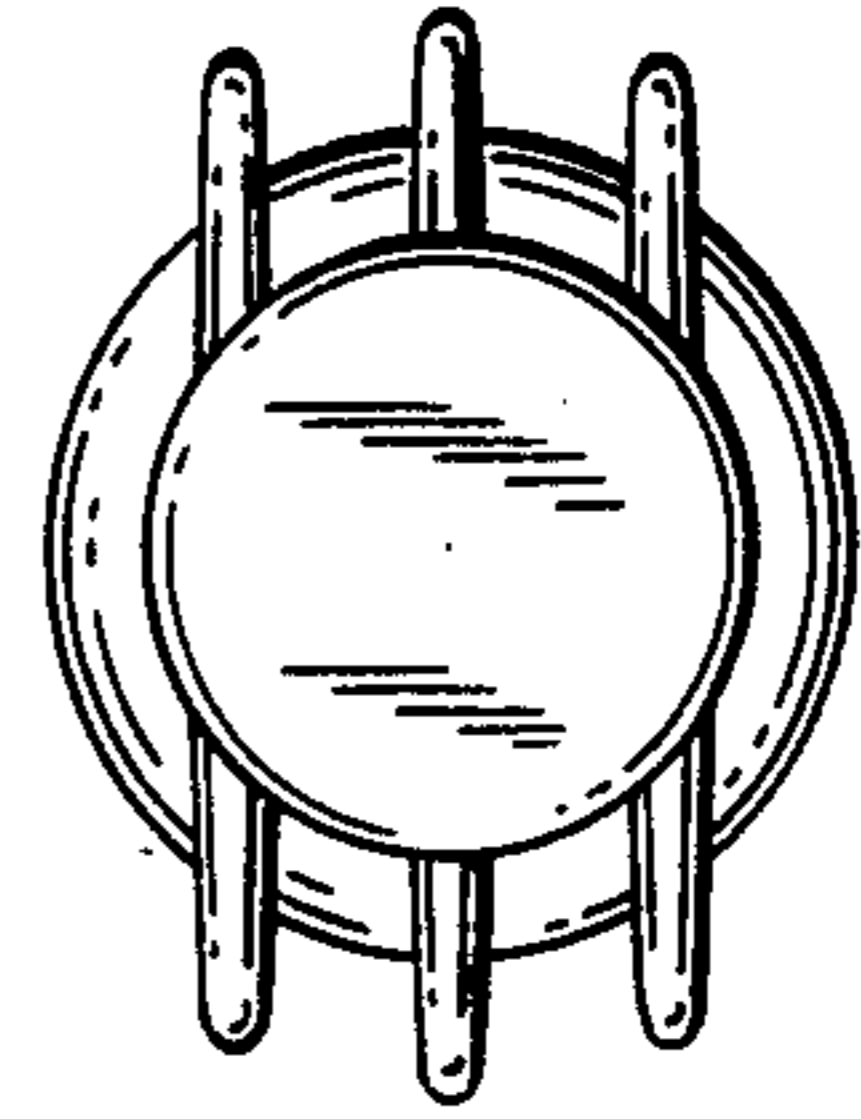
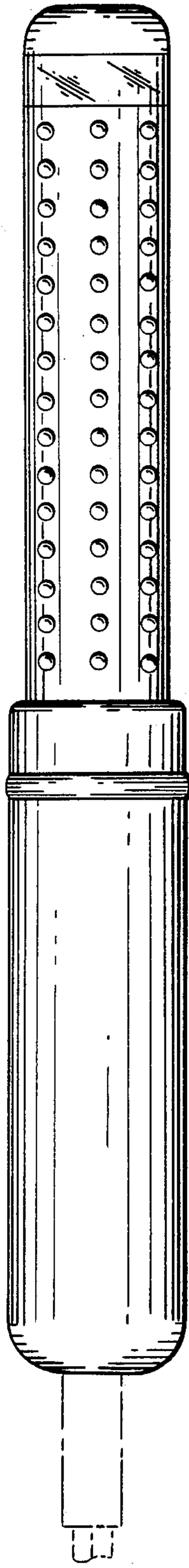

FIG. 3

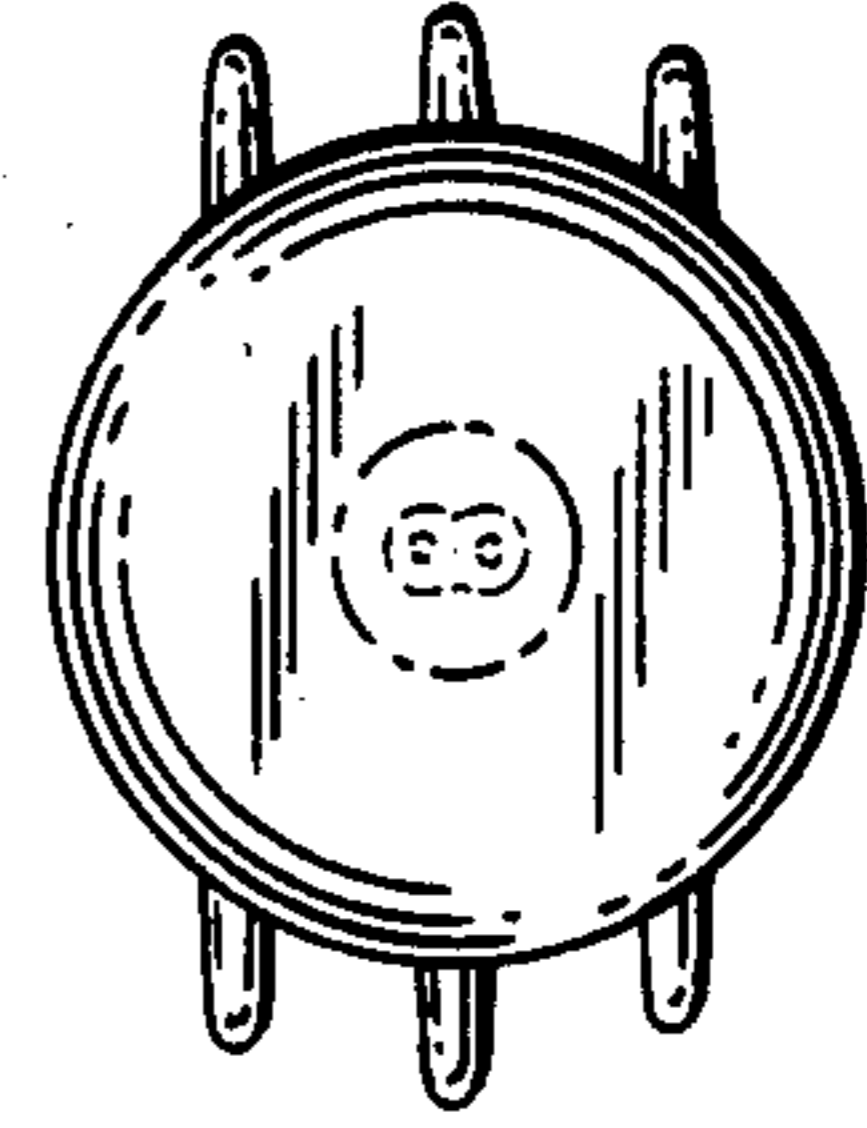

FIG. 4

FIG. 5

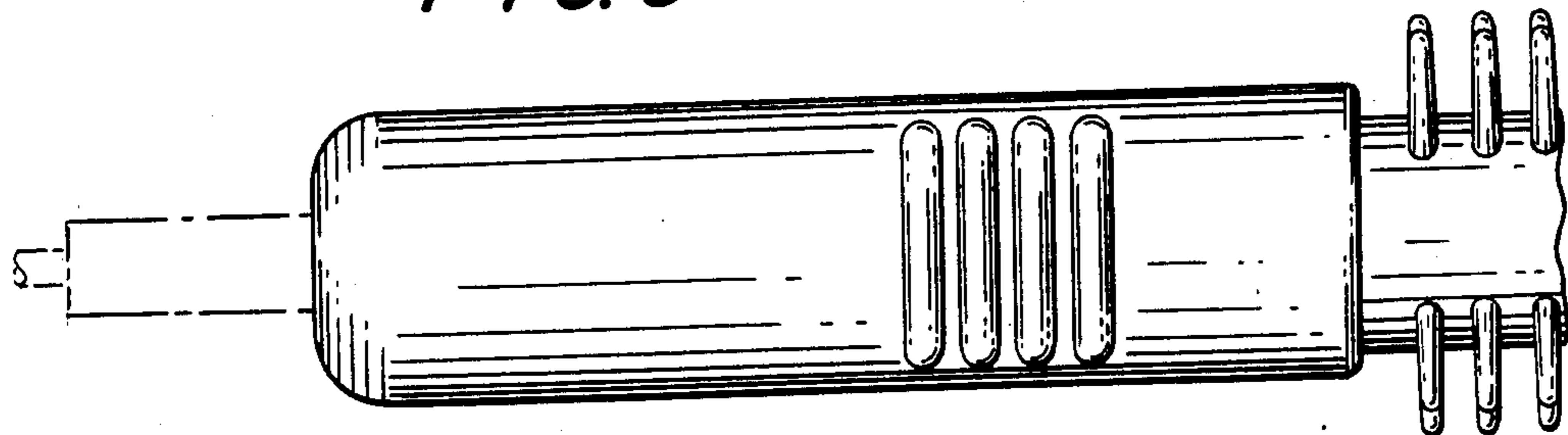

FIG. 6

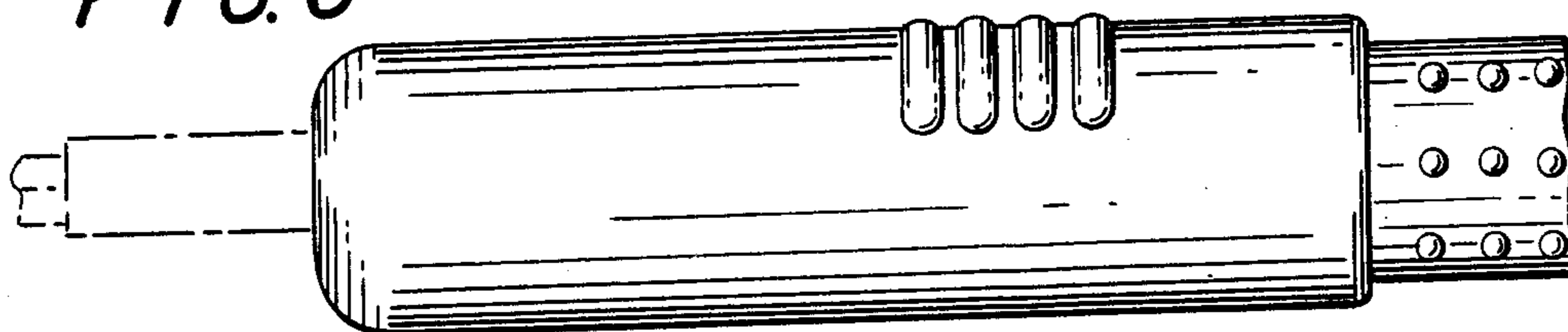

FIG. 7

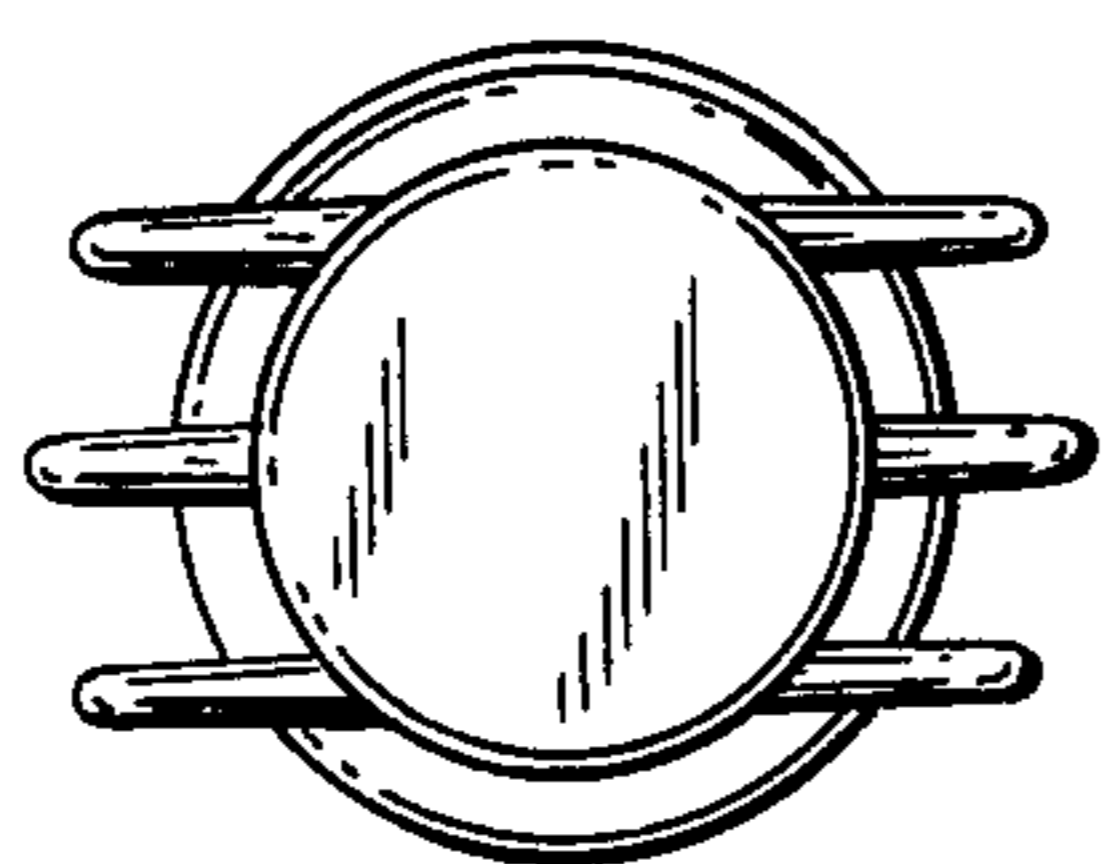
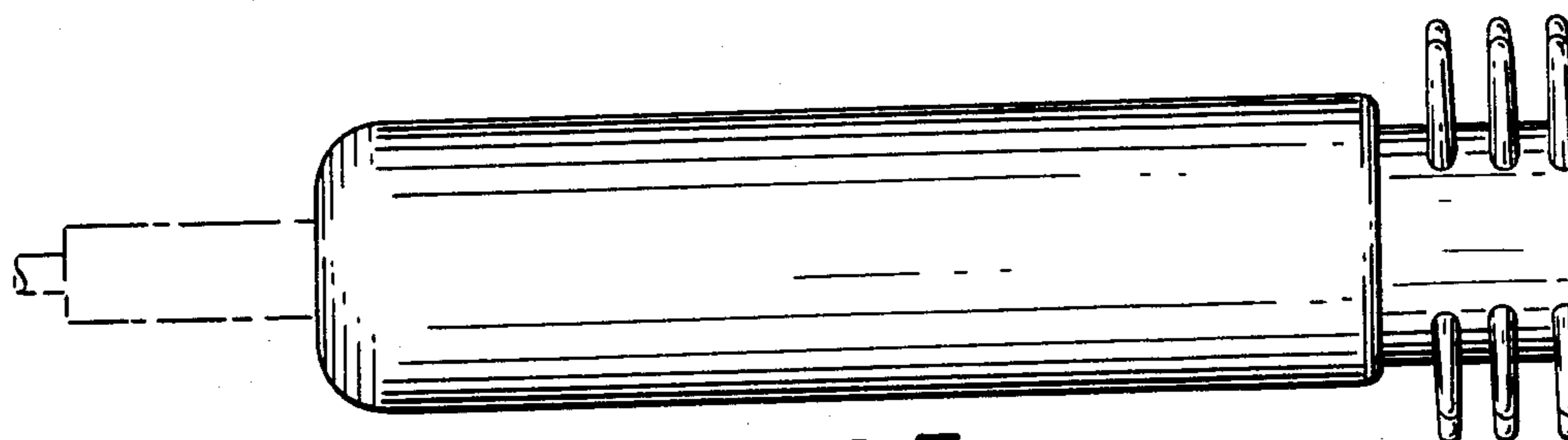
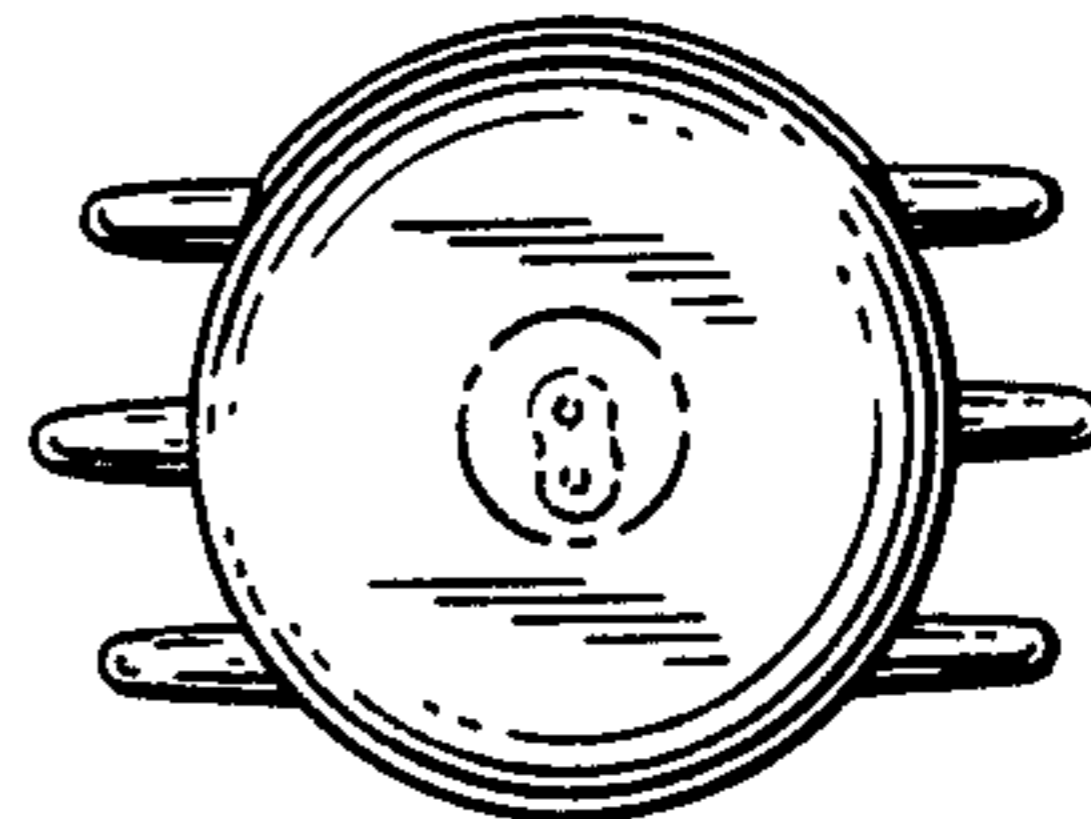

FIG. 8

FIG. 9



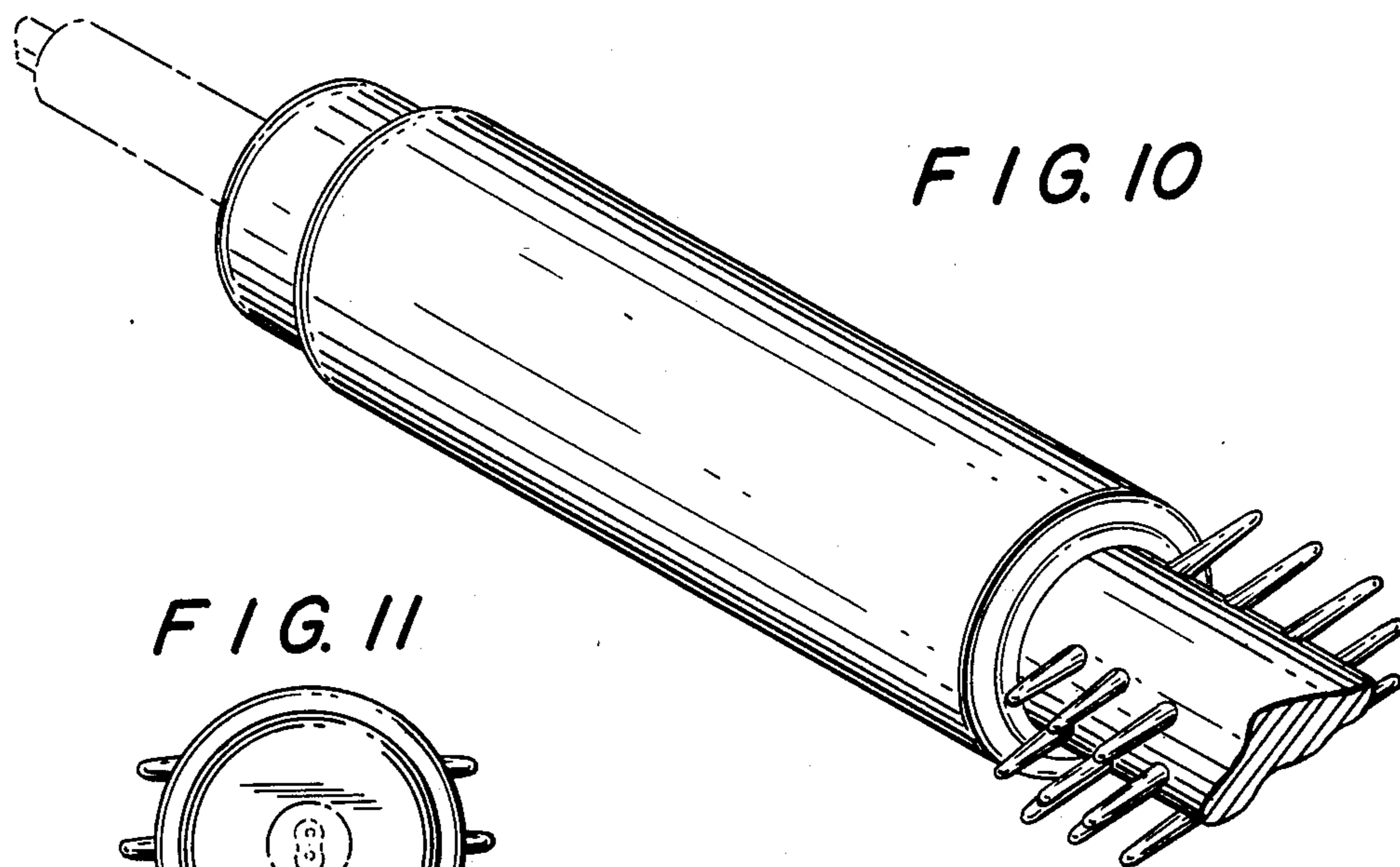

FIG. 11

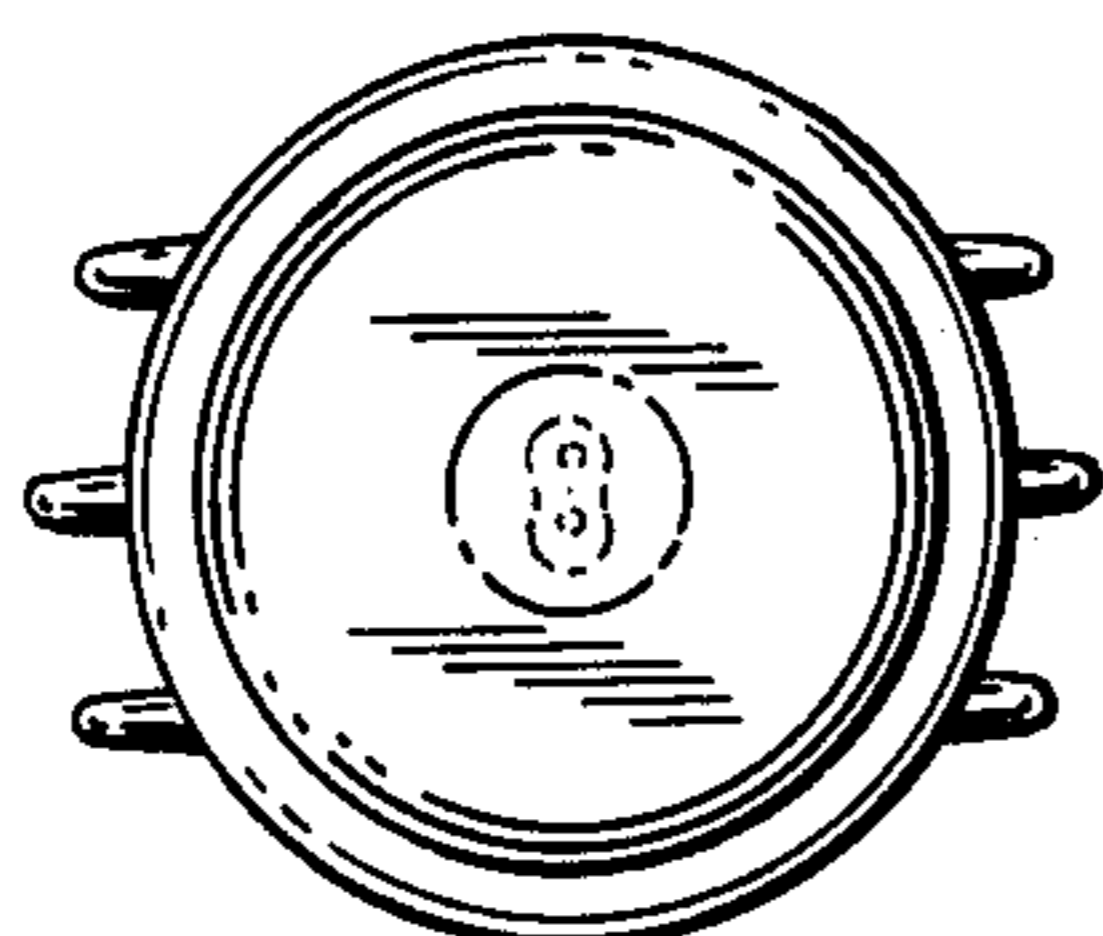

FIG. 12

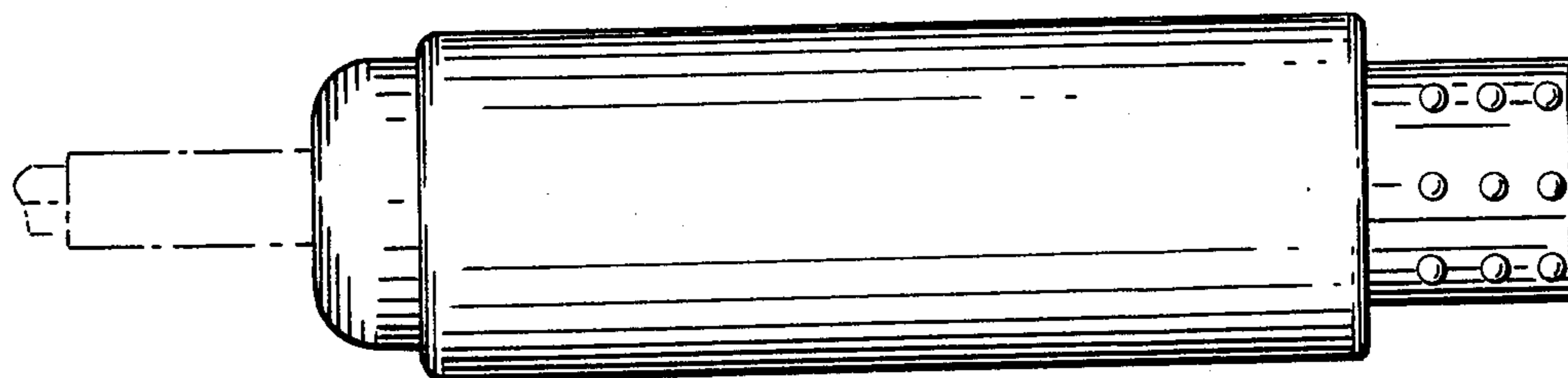
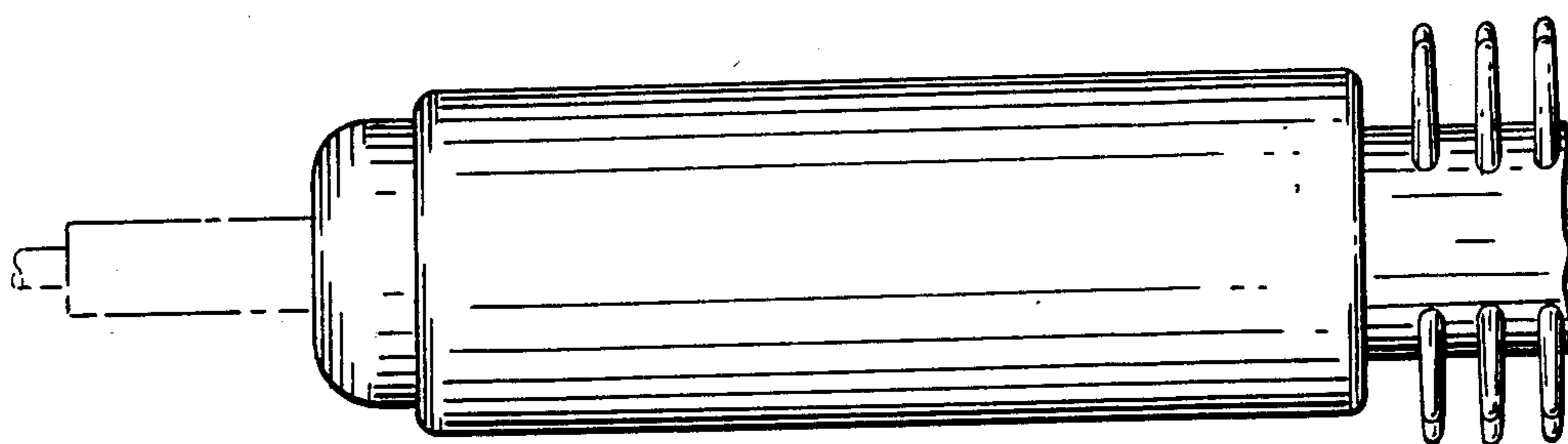

FIG. 13