

[54] SOFT HANDLE CURLING IRON

[75] Inventors: Kevin E. Reeves, Trumbull; John C. Wistrand, New Canaan, both of Conn.

[73] Assignee: Clairol Incorporated, New York, N.Y.

[**] Term: 14 Years

[21] Appl. No.: 888,620

[22] Filed: Jul. 23, 1986

[52] U.S. Cl. D28/35

[58] Field of Search D28/9-18, D28/24-26, 35, 37; 219/222, 225; 34/96-101; 132/79, 31 R, 32 R, 37 R, 37 A

[56] References Cited

U.S. PATENT DOCUMENTS

D. 254,812	4/1980	MacGregor	D28/35
D. 281,021	10/1985	Rittenhouse et al.	D28/35 X
D. 293,610	1/1988	Steinkamp	D28/35
D. 294,742	3/1988	Oberheim	D28/35
3,946,196	3/1976	Waters et al.	219/222
4,215,264	7/1980	Hetherington	219/225

Primary Examiner—Louis S. Zarfaz
Attorney, Agent, or Firm—Gene Warzecha

[57] CLAIM

The ornamental design for a soft handle curling iron, as shown and described.

DESCRIPTION

FIG. 1 is a perspective view of a soft handle curling iron showing our new design;
 FIG. 2 is a top plan view thereof;
 FIG. 3 is a right end view of FIG. 2;
 FIG. 4 is a side elevational view thereof;
 FIG. 5 is a left end view of FIG. 4;
 FIG. 6 is a bottom plan view thereof;
 FIG. 7 is a partial top plan view of a soft handle curling iron showing a modified form of our new design wherein only the top is modified;
 FIG. 8 is a partial perspective view of a soft handle curling iron showing another modified form of our new design wherein only the tip is modified;
 FIG. 9 is a perspective view of a soft handle curling iron showing a fourth embodiment of our new design;
 FIG. 10 is a top plan view thereof;
 FIG. 11 is a right end view thereof;
 FIG. 12 is a side elevational view thereof;
 FIG. 13 is a left end view thereof;
 FIG. 14 is a bottom plan view thereof;
 FIG. 15 is a partial perspective view of a soft handle curling iron showing a fifth embodiment of our new design wherein only the tip is modified.
 The broken line showing of a power cord in FIGS. 1, 2 4-7, 9, 10, and 12-14 is for illustrative purposes only and forms no part of the claimed design.

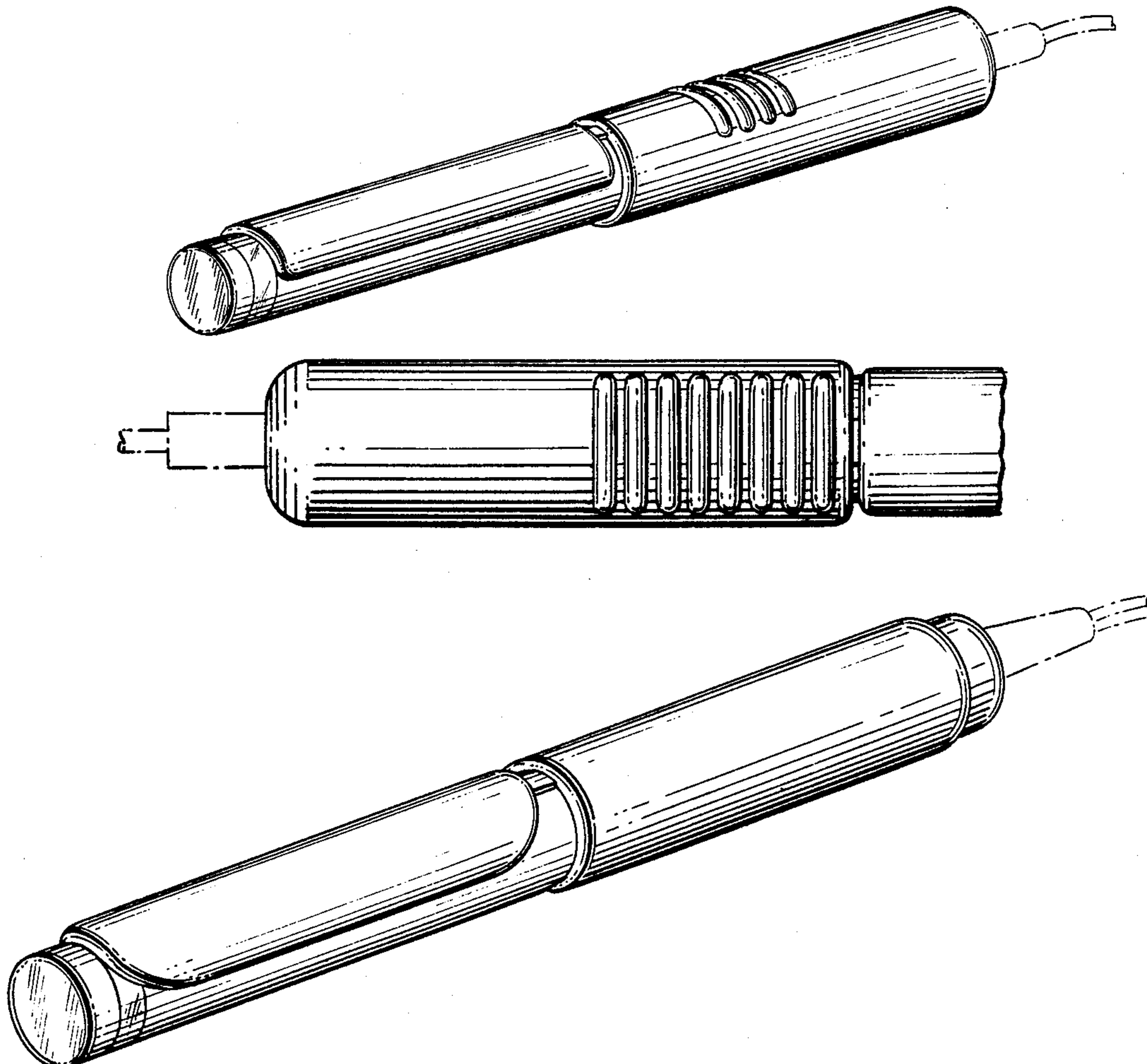

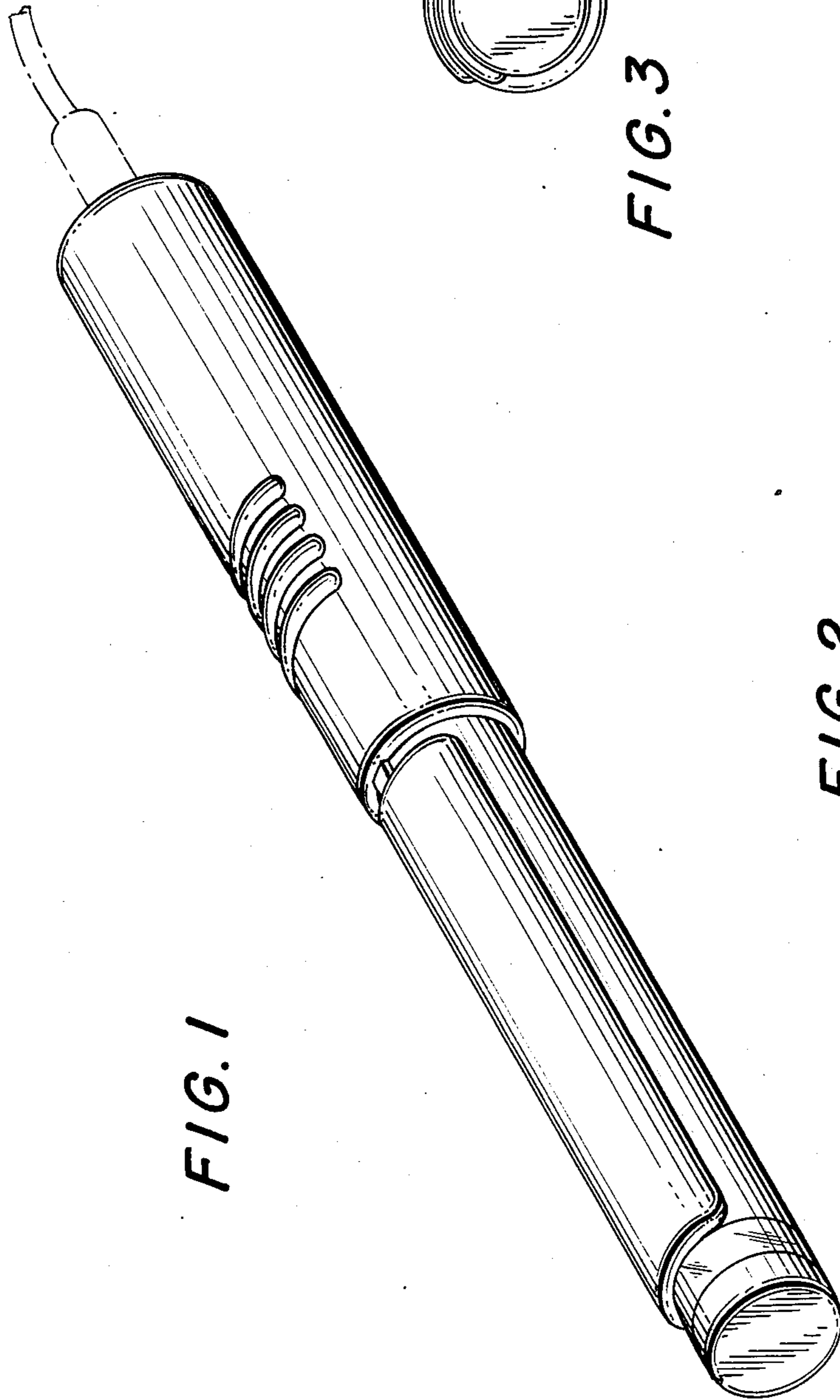

FIG. 1

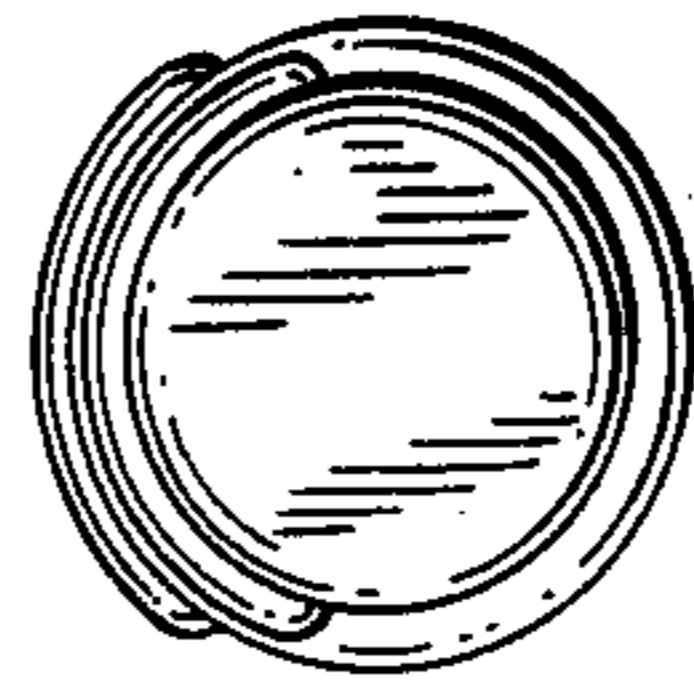

FIG. 3

FIG. 2

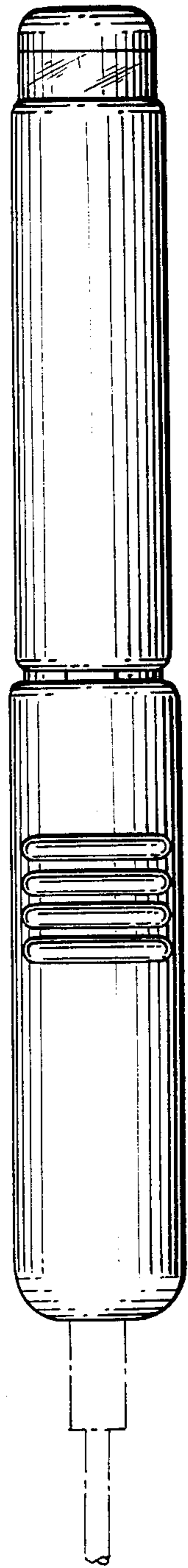

FIG. 4

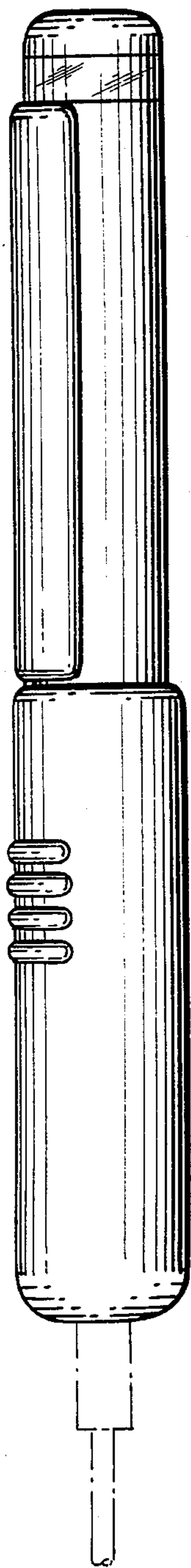

FIG. 7

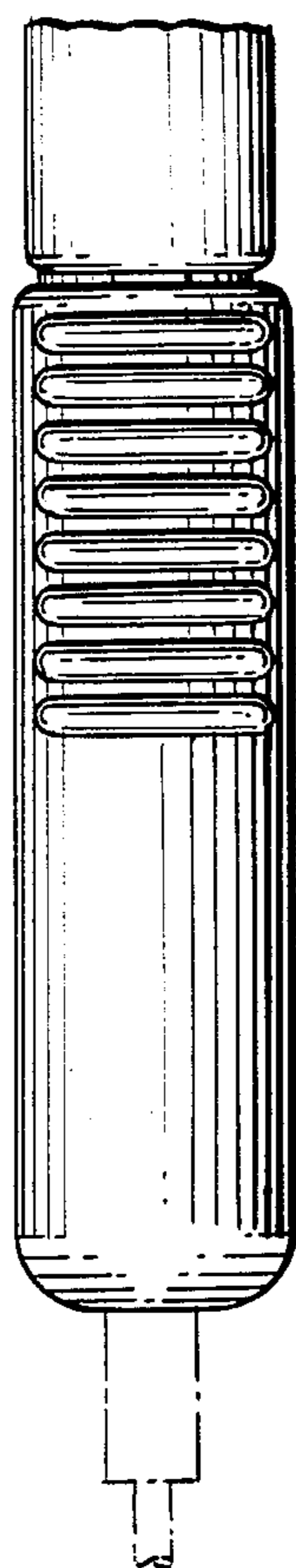

FIG. 8

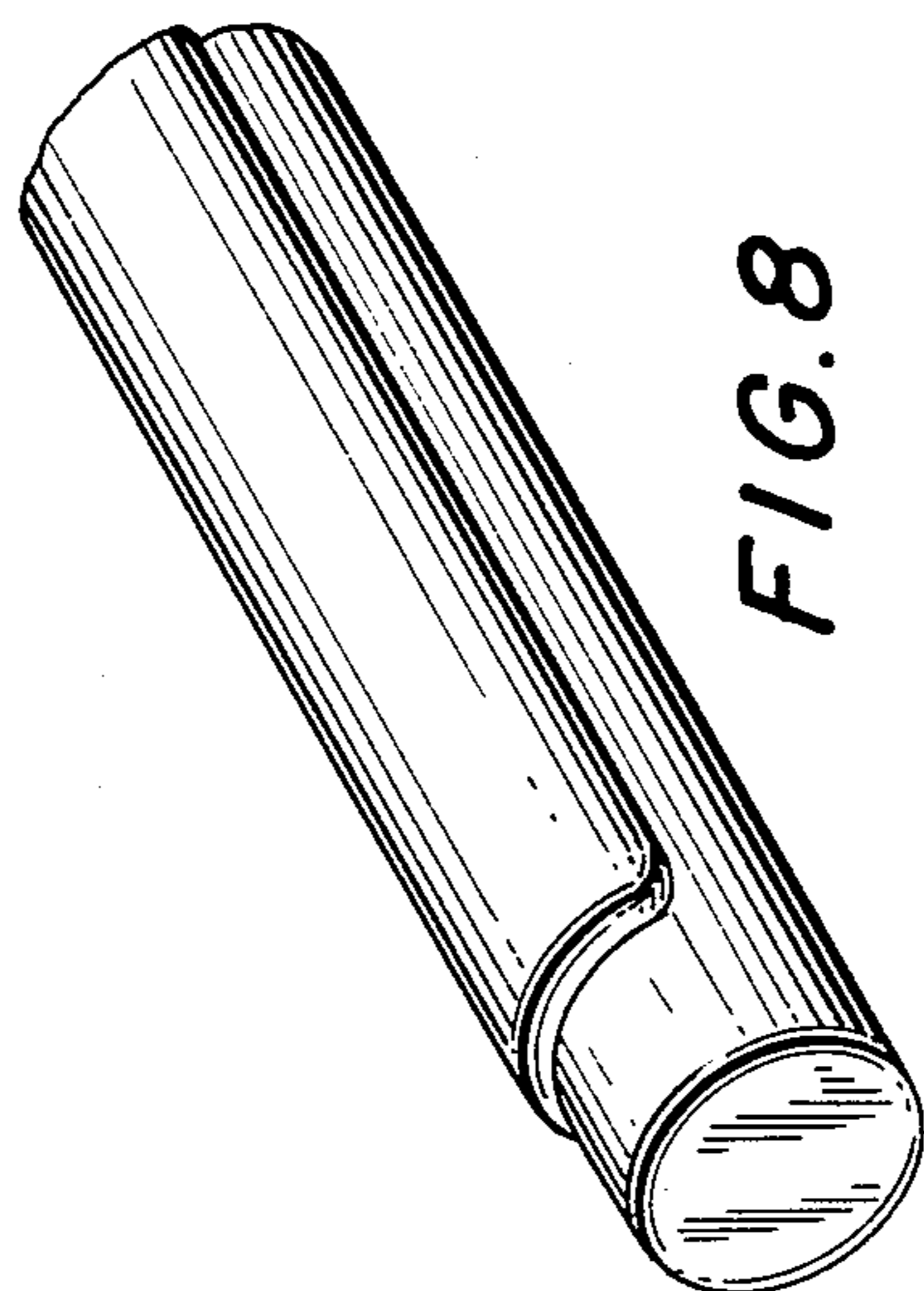

FIG. 5

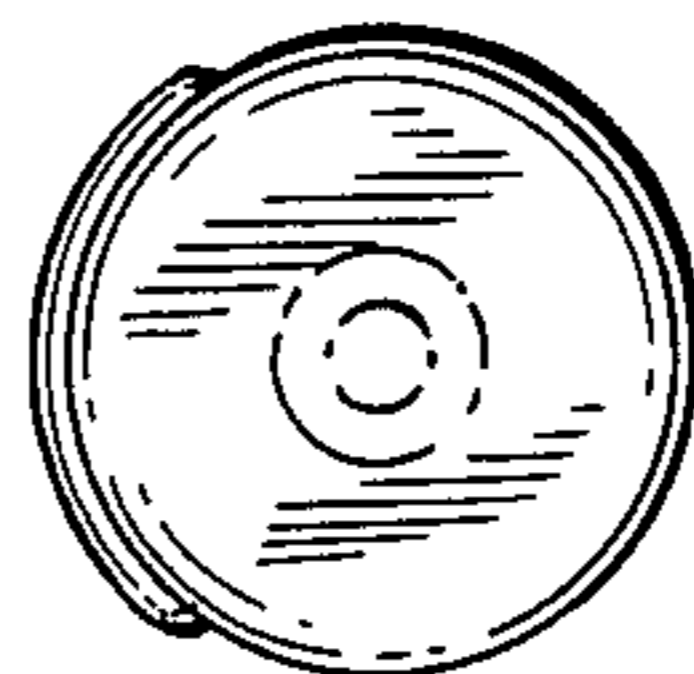
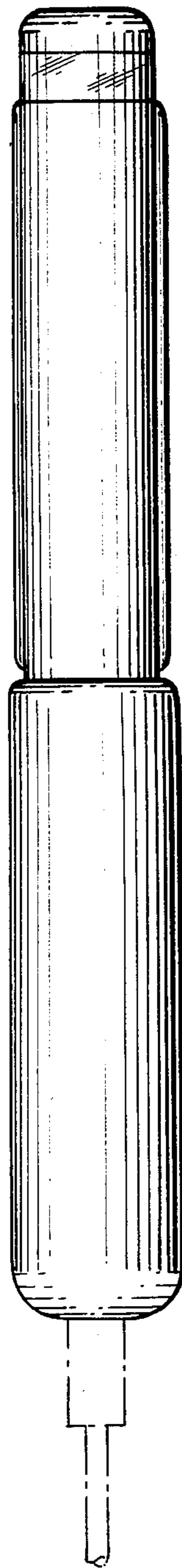

FIG. 6



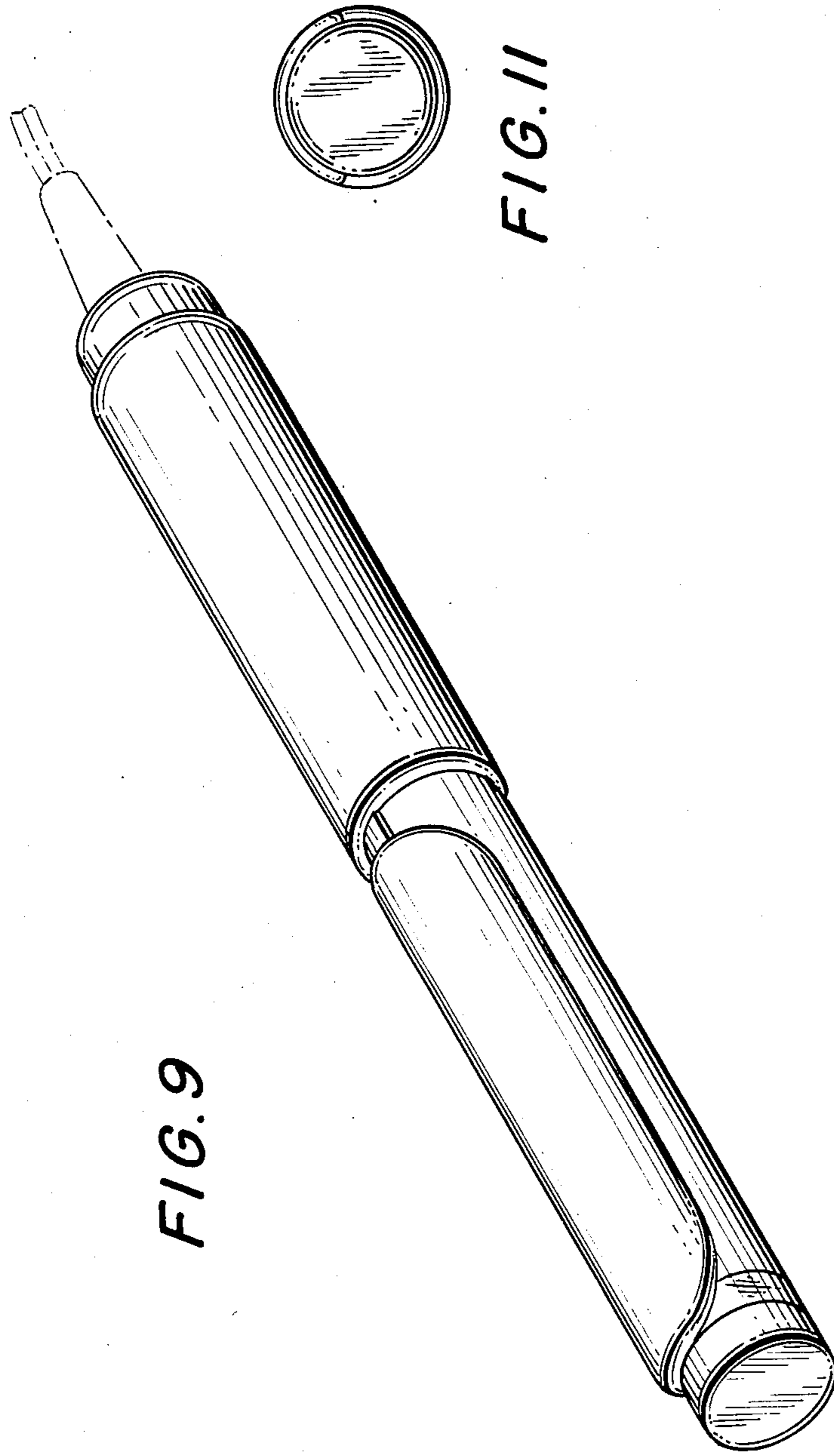

FIG. 9

FIG. 11

FIG. 10

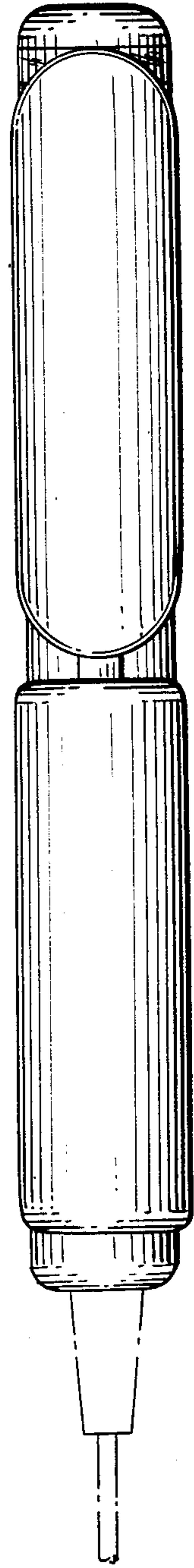

FIG. 12

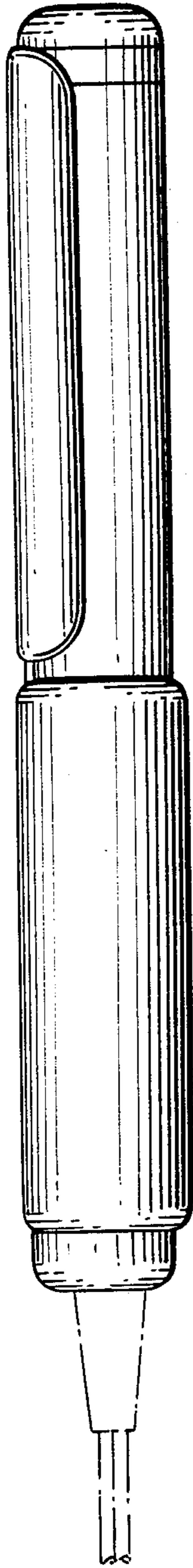

FIG. 13

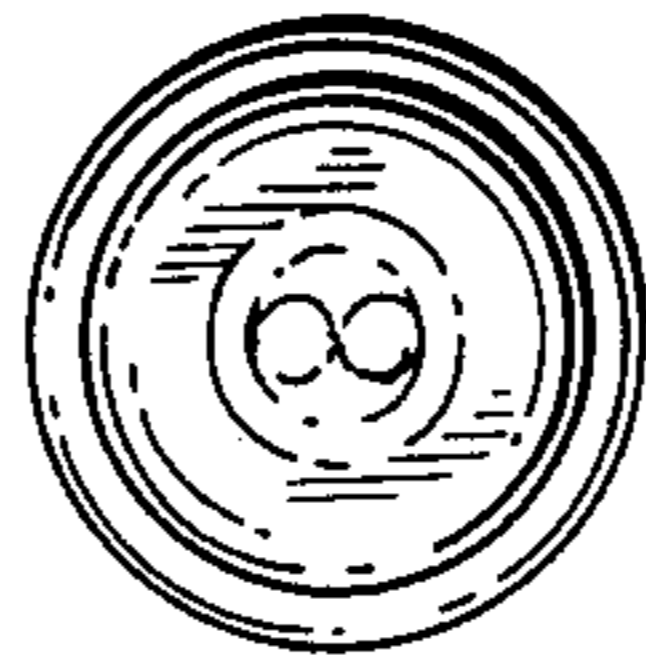

FIG. 14

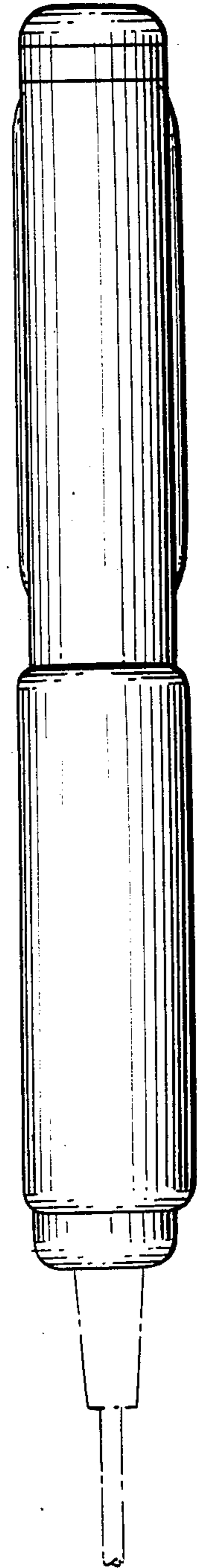

FIG. 15

