

[54] MODULAR VIDEO CASSETTE DISPLAY RACK

[76] Inventor: John S. Pate, 2498 Glenhaven Dr.,
Gainesville, Ga. 30501

[**] Term: 14 Years

[21] Appl. No.: 817,016

[22] Filed: Jan. 8, 1986

[52] U.S. Cl. D6/407

[58] Field of Search D6/407, 449, 462, 467;
D3/55; 211/169, 45

[56] References Cited

U.S. PATENT DOCUMENTS

D. 239,231	3/1976	Cockcroft	D6/407
D. 239,232	3/1976	Cockcroft	D6/407
D. 244,499	5/1977	Parfitt	D6/467 X
887,882	5/1908	Waugh	211/169
3,135,388	6/1964	Lang	211/45 X

Primary Examiner—Carmen H. Vales
Attorney, Agent, or Firm—Jones, Askew & Lunsford

[57] CLAIM

The ornamental design for a modular video cassette display rack, as shown and described.

DESCRIPTION

FIG. 1 is a perspective view of a modular video cassette display rack showing my new design;
FIG. 2 is an enlarged top plan view thereof;
FIG. 3 is a bottom plan view thereof;
FIG. 4 is a front elevational view thereof, with the horizontal shelves shortened for convenience of illustration:

FIG. 5 is a right side elevational view thereof;
FIG. 6 is a rear elevational view thereof;
FIG. 7 is a left side elevational view thereof; and
FIG. 8 is a fragmentary detailed view of the support shelf.

The broken line showing of a cassette in FIGS. 1, 4, 6 and 8 are for illustrative purposes only.

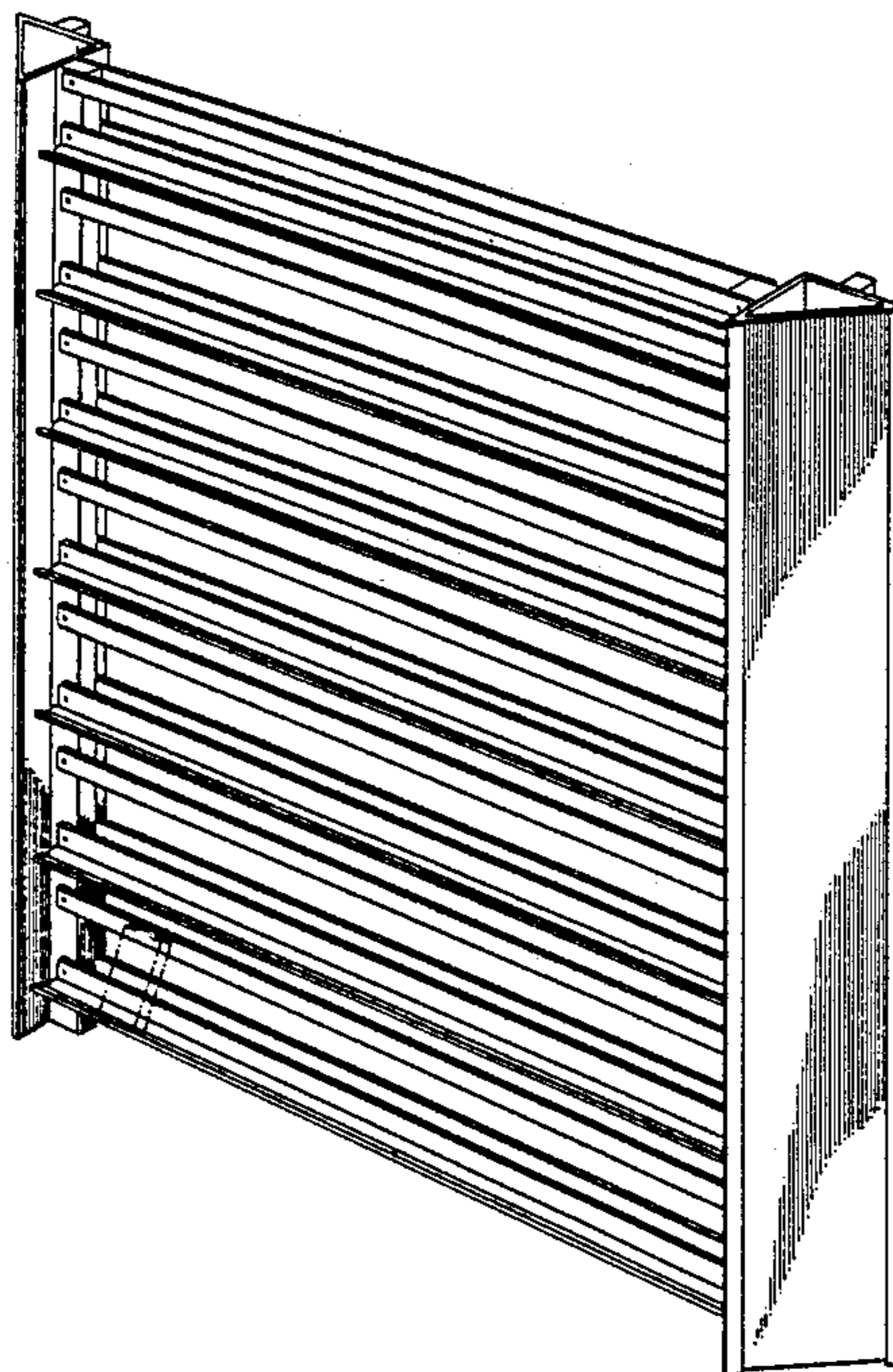

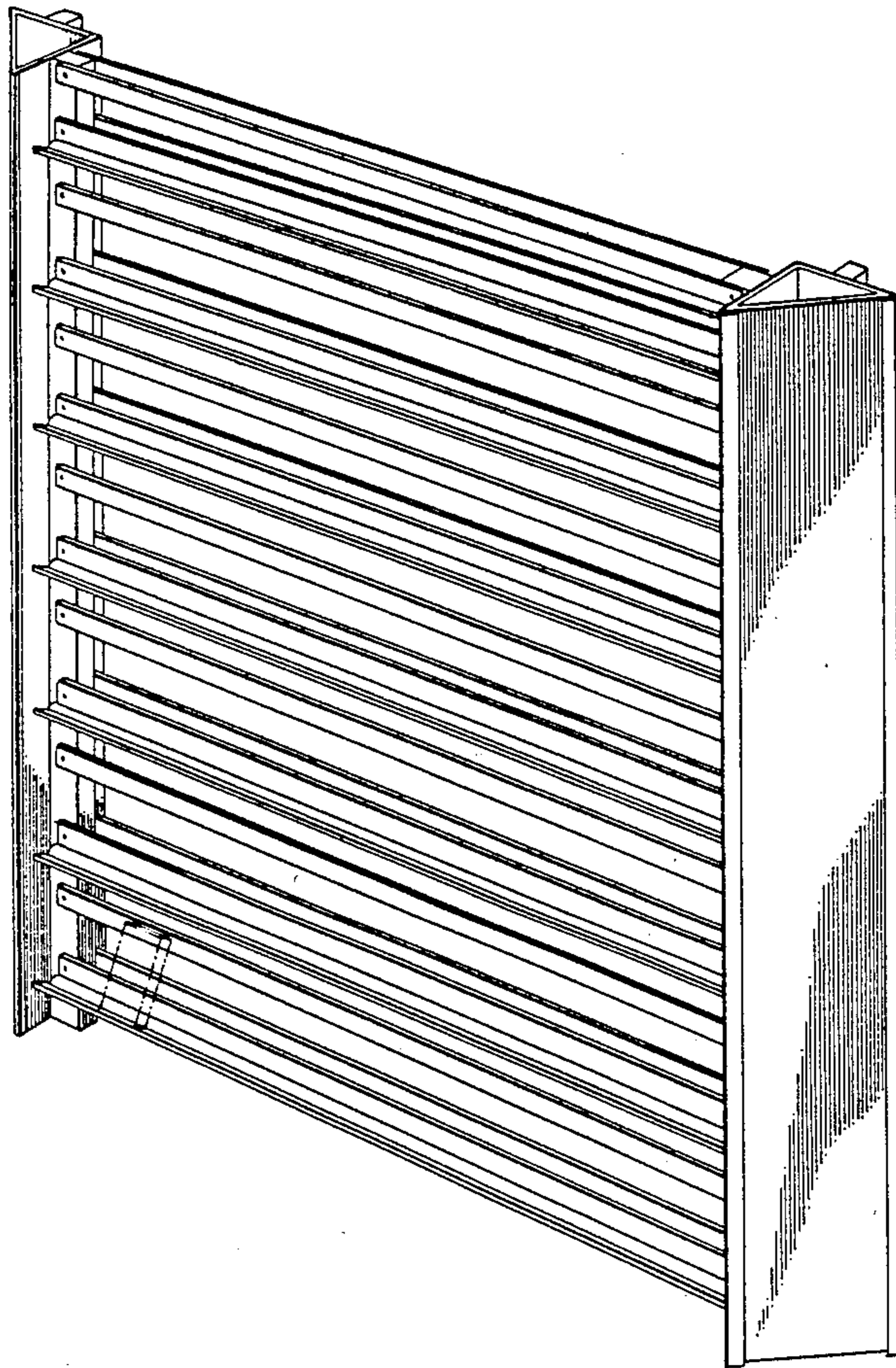

Fig. 1

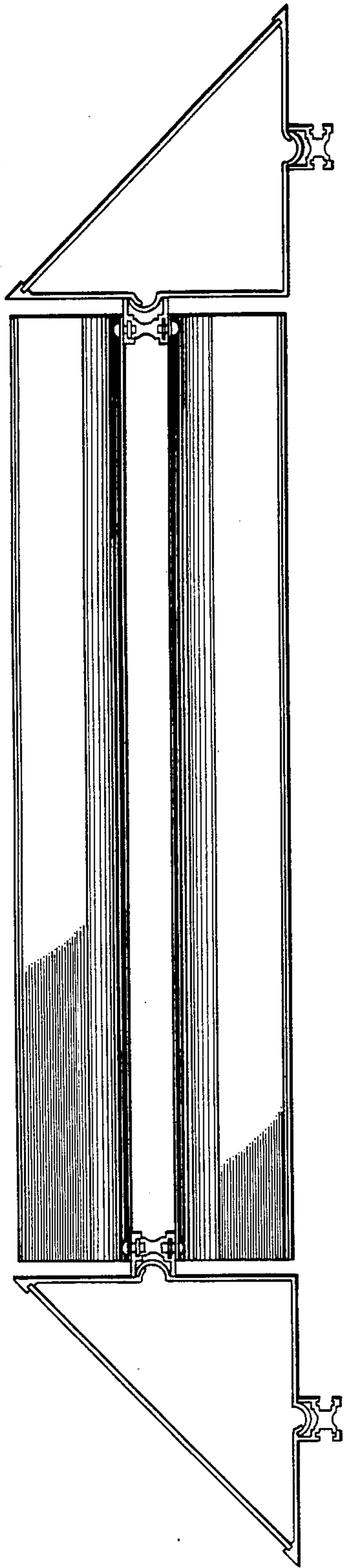

Fig. 2

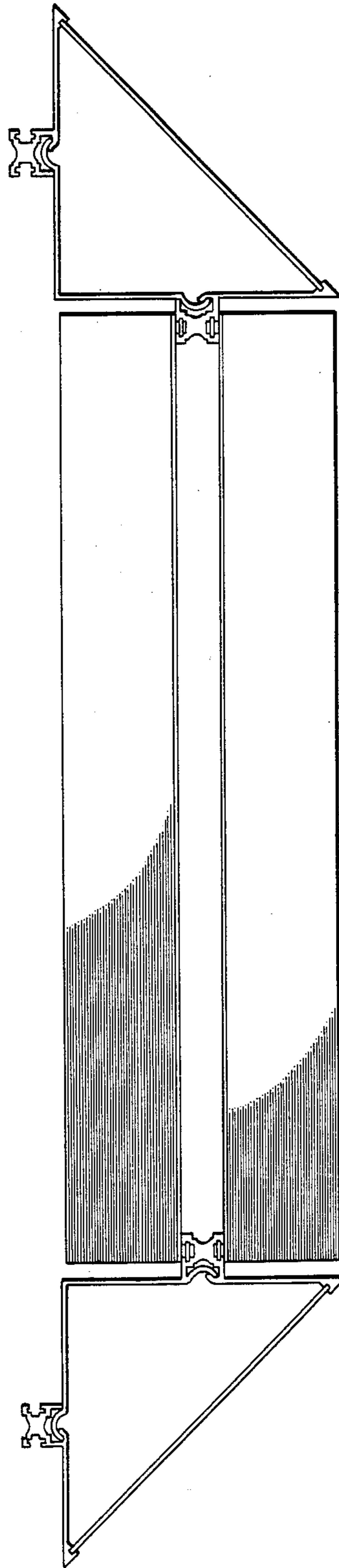

Fig. 3

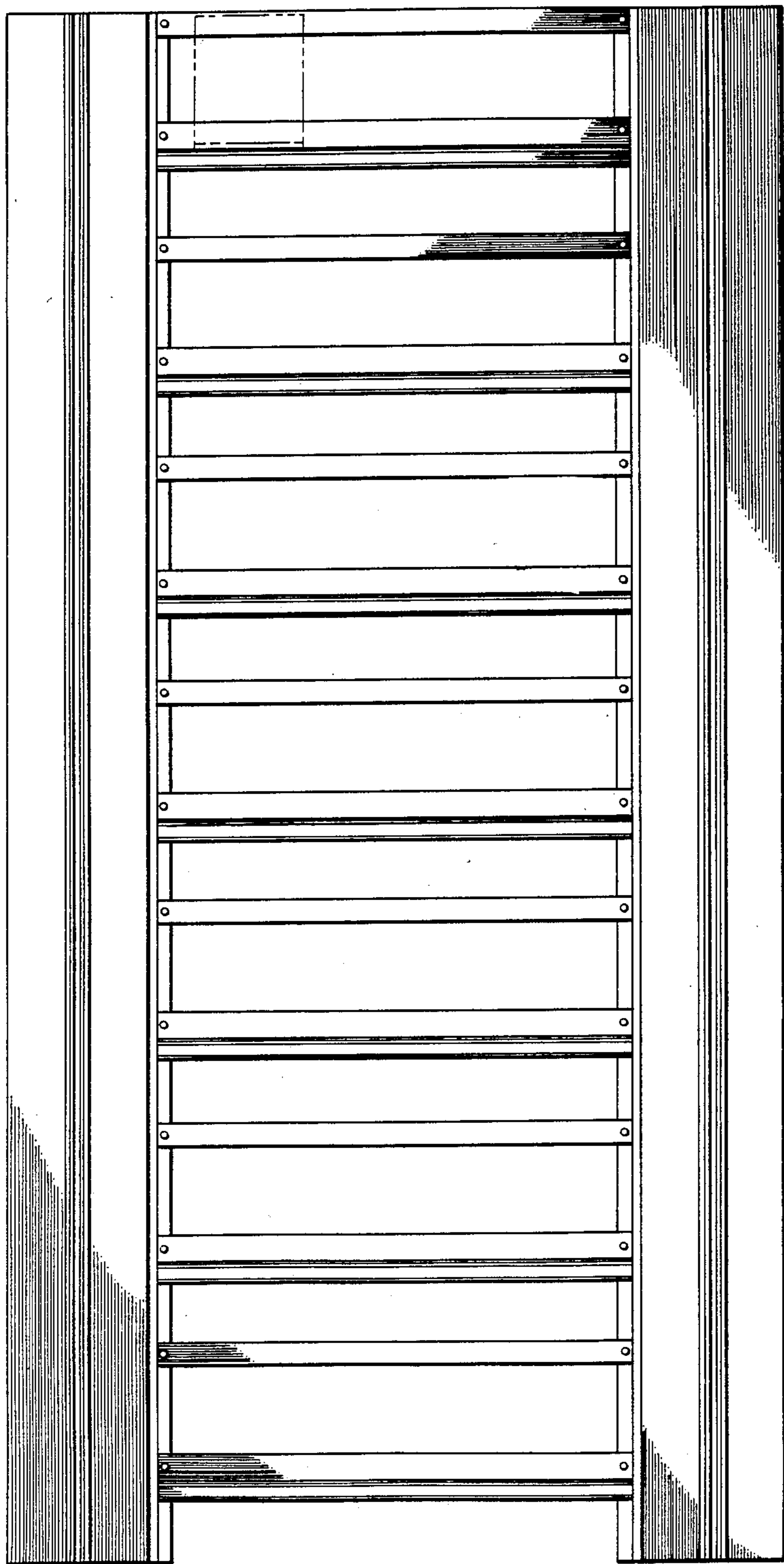

Fig. 4

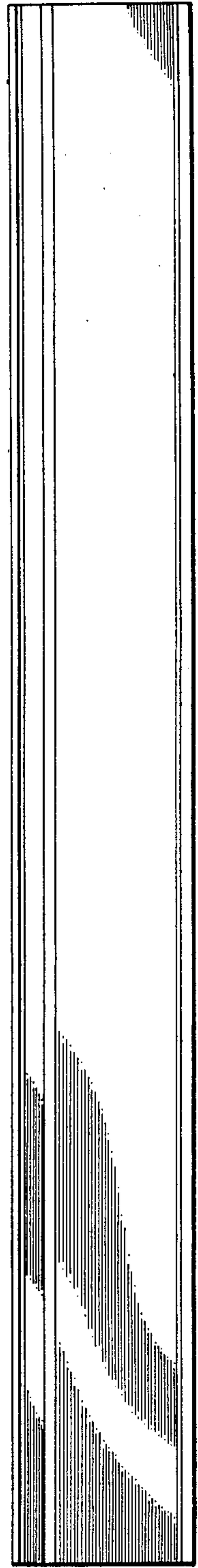

Fig. 5

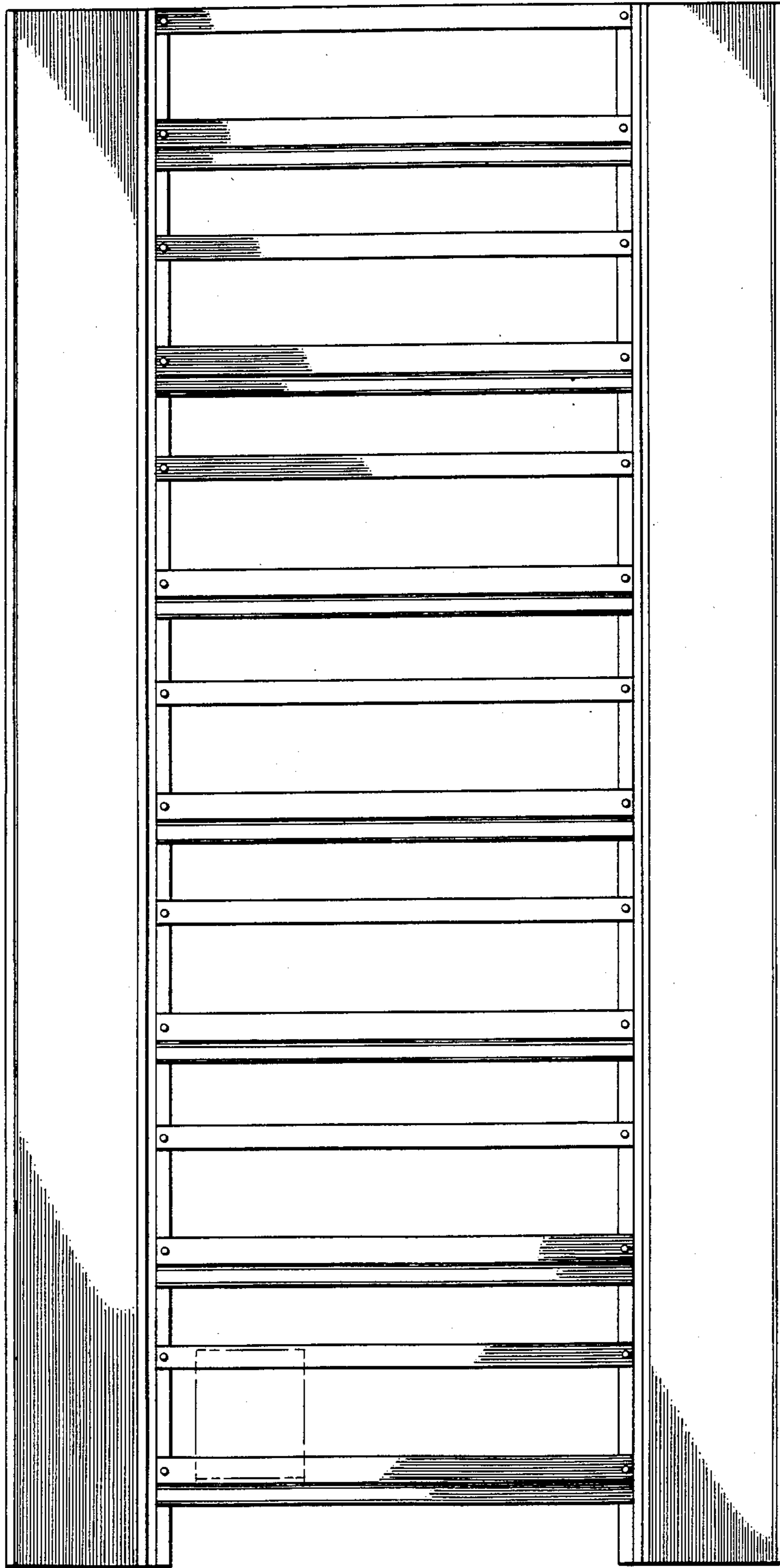

Fig. 6

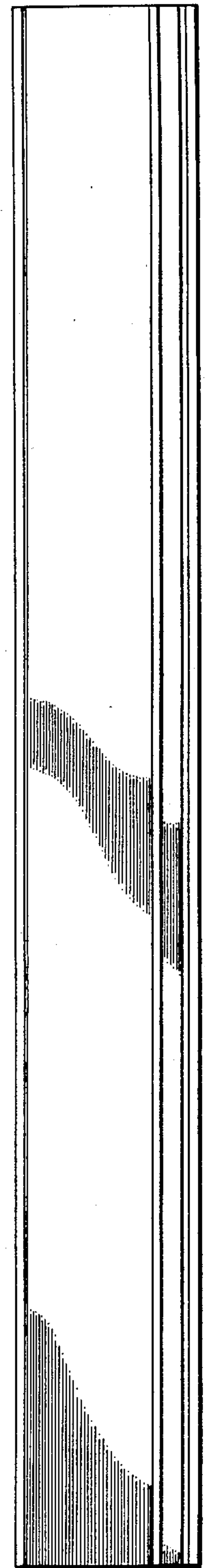

Fig. 7

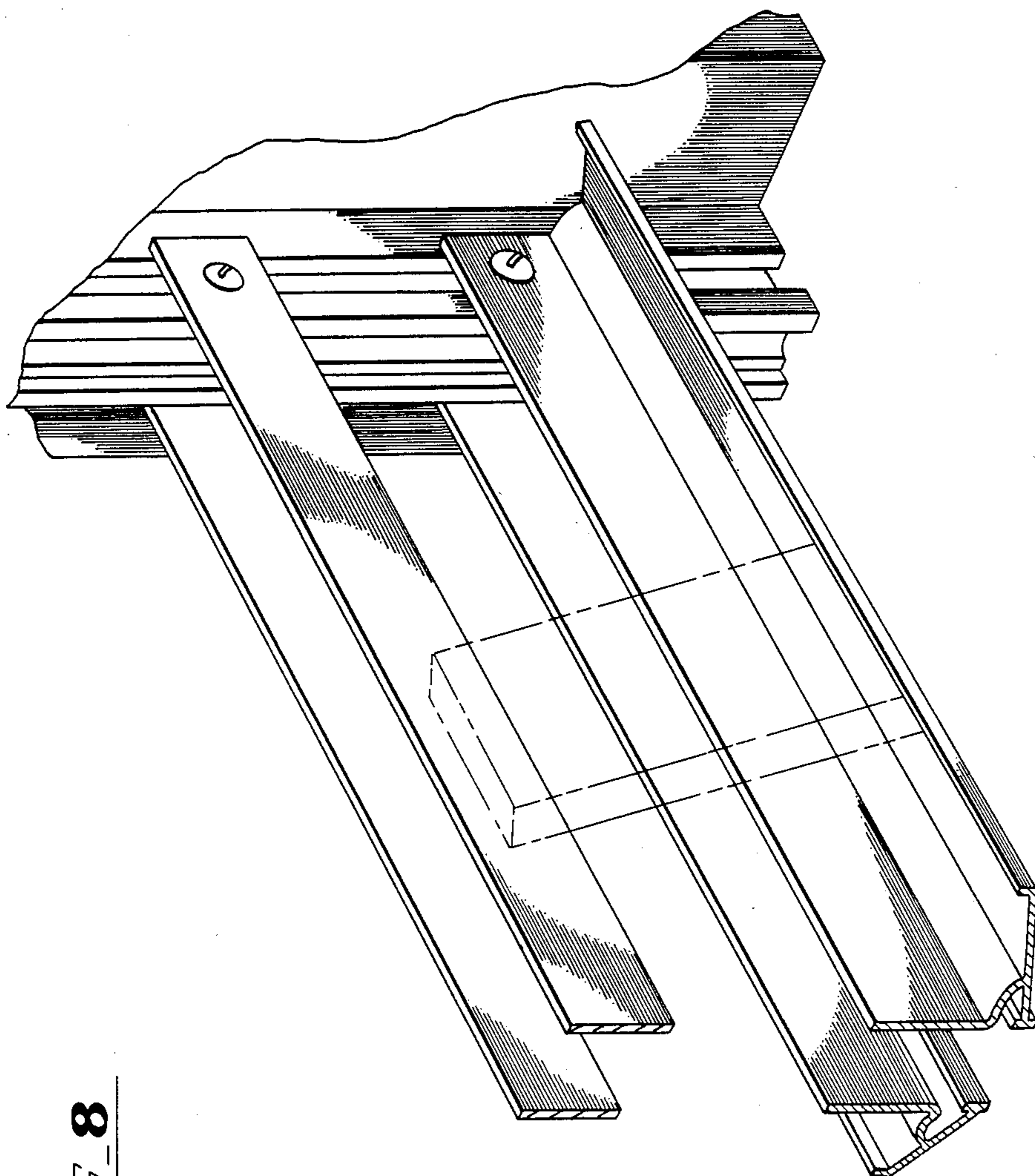

FIG. 8