

[54] RETAINING WALL WITH TIE-BACK ELEMENTS

[76] Inventor: H. Joe Meheen, 1860 Lincoln St., Ste. 1026, Denver, Colo. 80295

[**] Term: 14 Years

[21] Appl. No.: 836,448

[22] Filed: Feb. 25, 1986

Related U.S. Application Data

[63] Continuation-in-part of Ser. No. 738,642, May 28, 1985.

[52] U.S. Cl. D25/58; D25/113

[58] Field of Search 405/284, 285, 286; D25/38, 113, 116, 58, 35, 114, 117

References Cited

U.S. PATENT DOCUMENTS

D. 288,616	3/1987	Hilfiker	D25/113
4,000,622	1/1977	Chiaves	405/286
4,050,254	9/1977	Meheen	405/285

Primary Examiner—A. Hugo Word
Attorney, Agent, or Firm—Fields, Lewis, Pittenger & Rost

[57] CLAIM

The ornamental design for a retaining wall with tie-back elements, as shown and described.

DESCRIPTION

FIG. 1 is a front elevational view of a retaining wall with tie-back elements showing my new design.

FIG. 2 is a top elevation of the retaining wall with tie-back elements;

FIG. 3 is an enlarged perspective view of a tie-back element of FIGS. 1 and 2;

FIG. 4 is a side elevation of the tie-back element of FIG. 3;

FIG. 5 is a rear end elevation of the tie-back element of FIG. 3;

FIG. 6 is a top plan view of the tie-back element of FIG. 3; and

FIG. 7 is a bottom plan view of the tie-back element of FIG. 3.

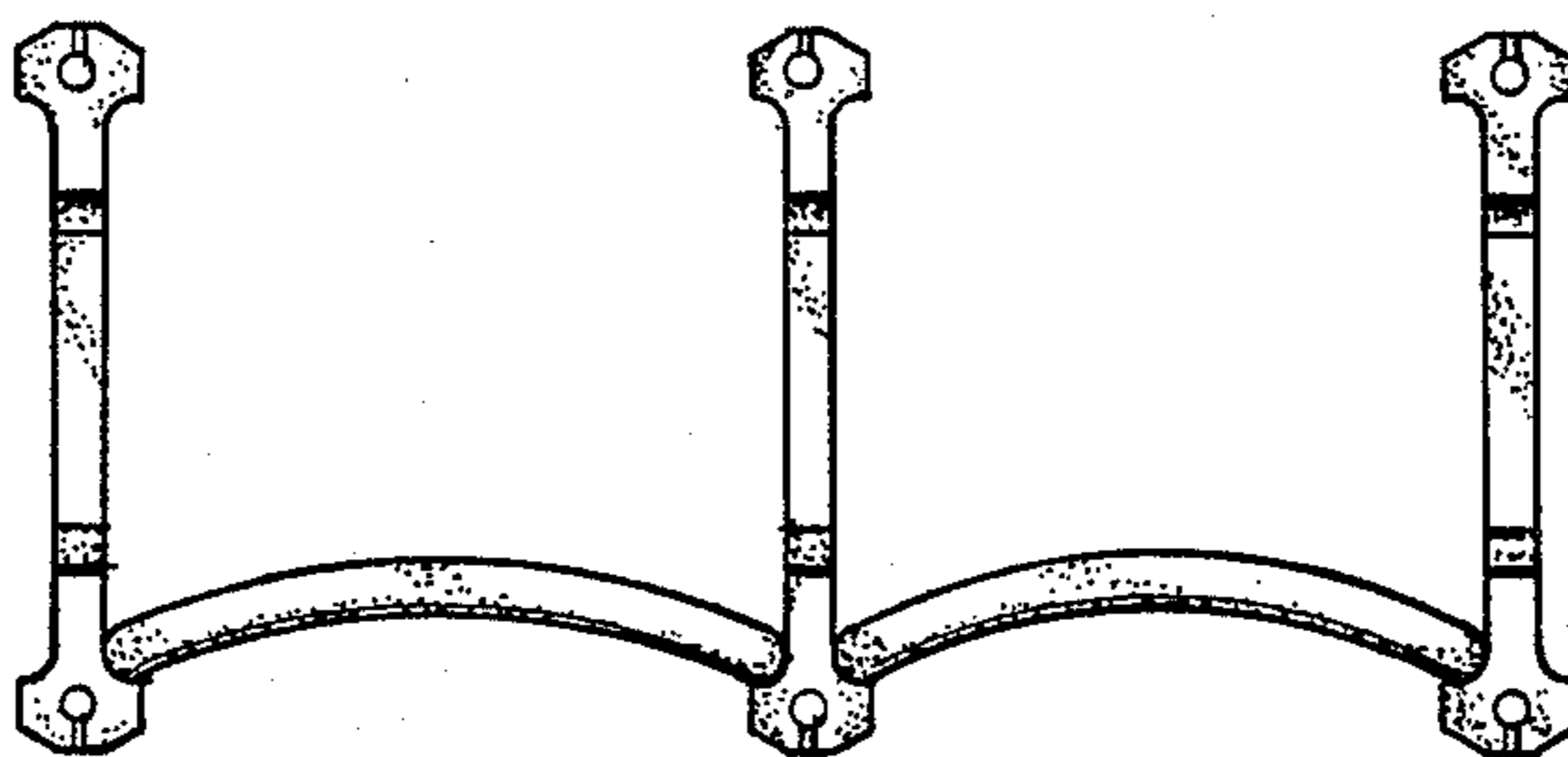
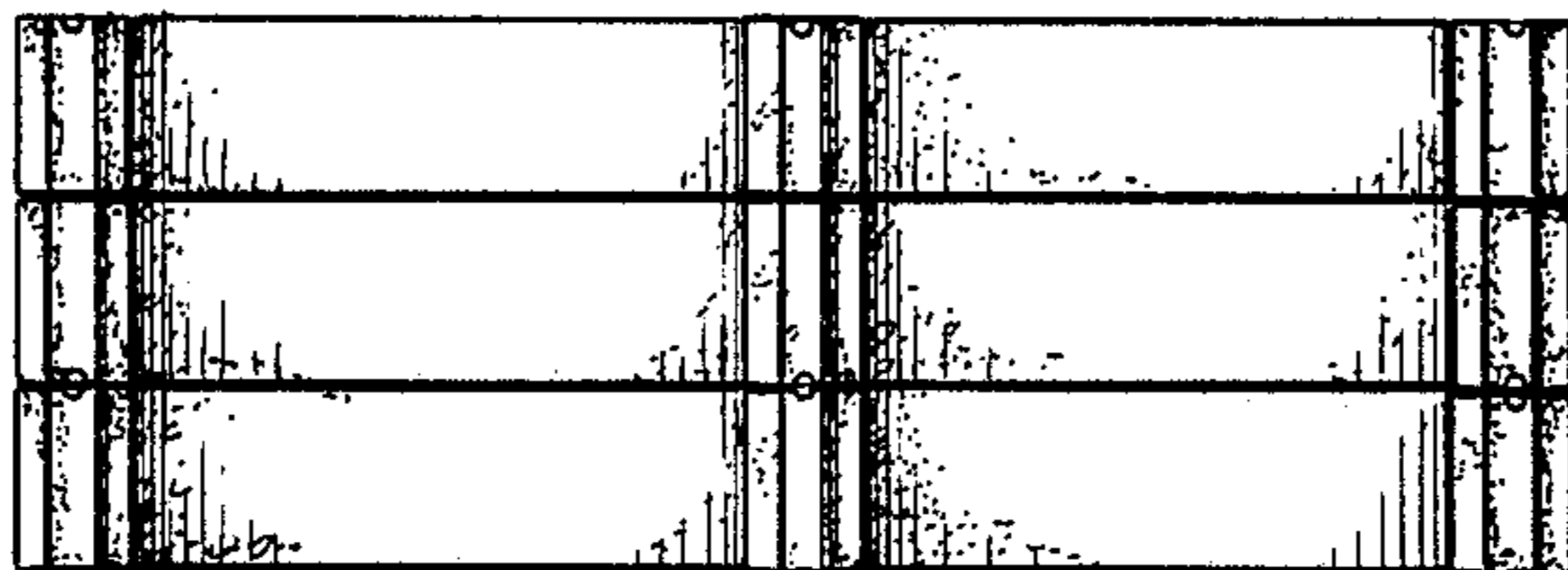

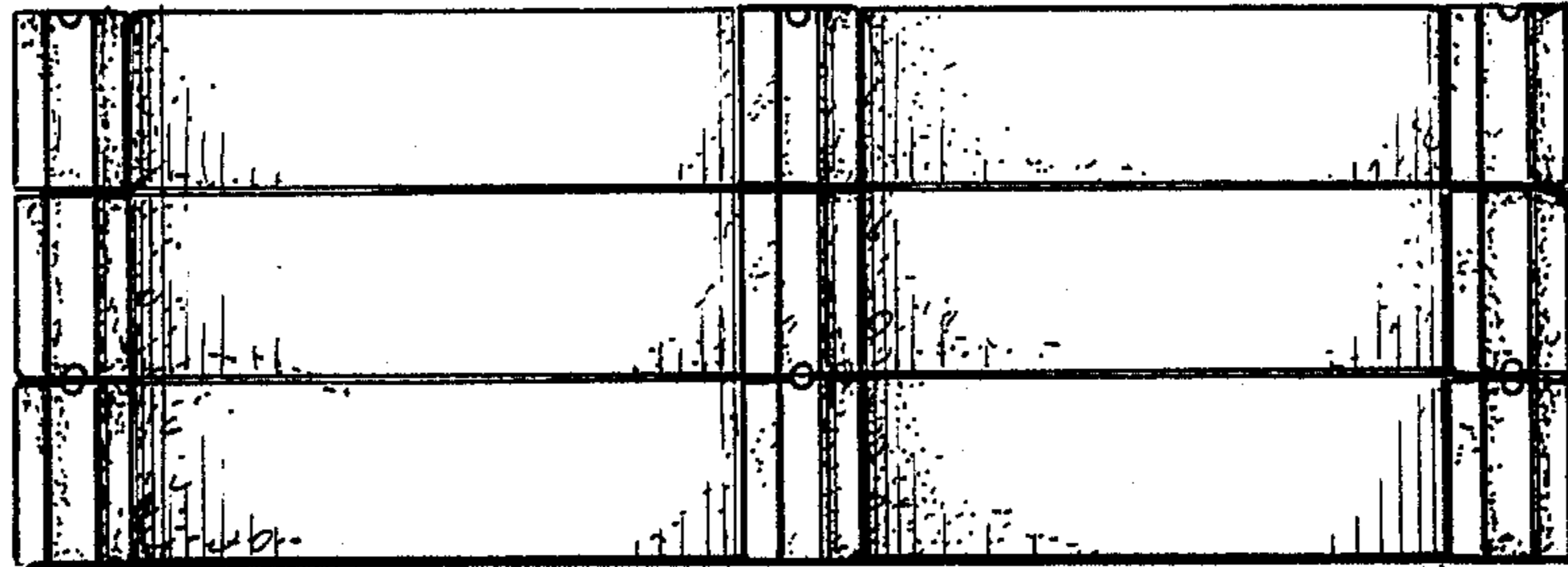

Fig. 1

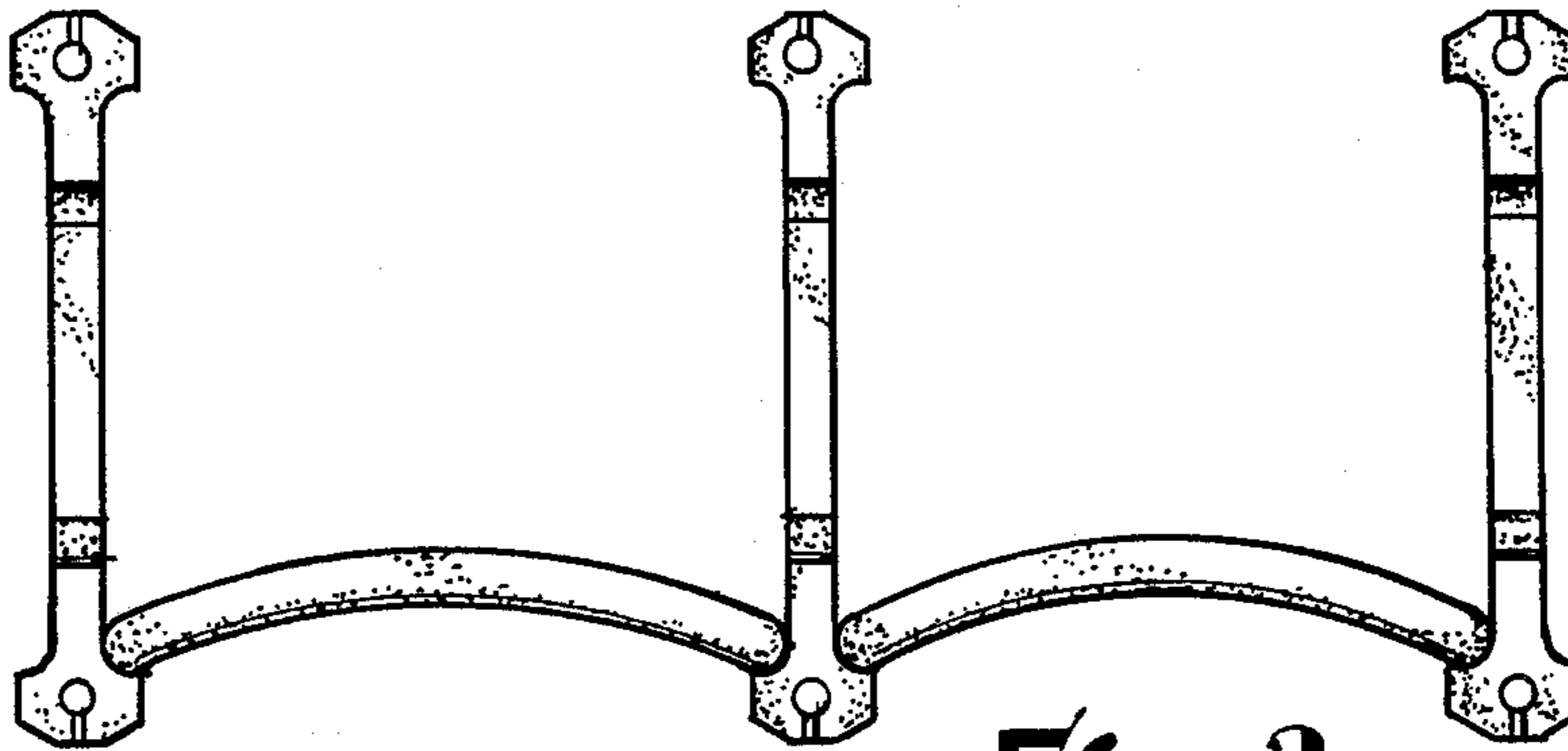

Fig. 2

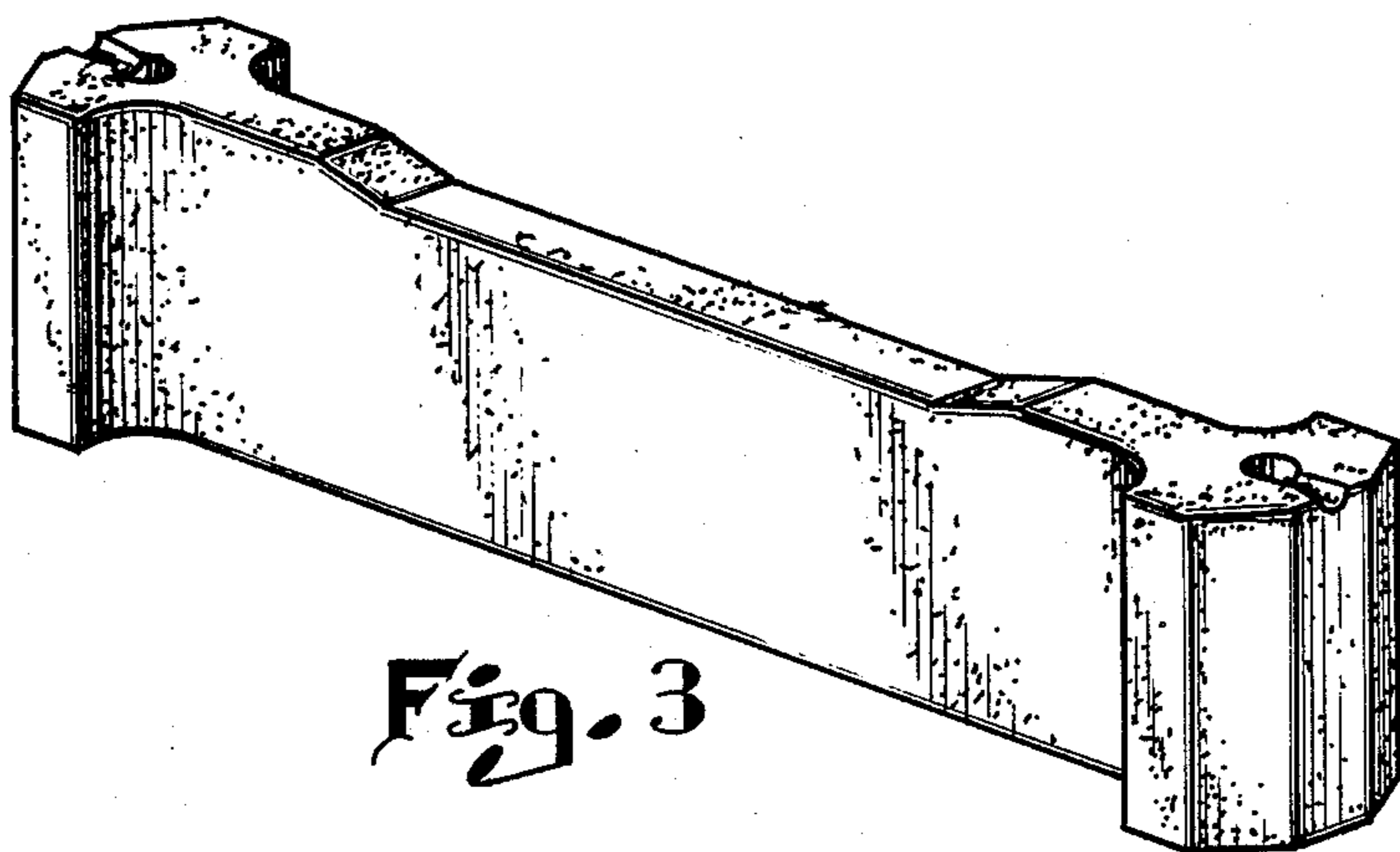

Fig. 3

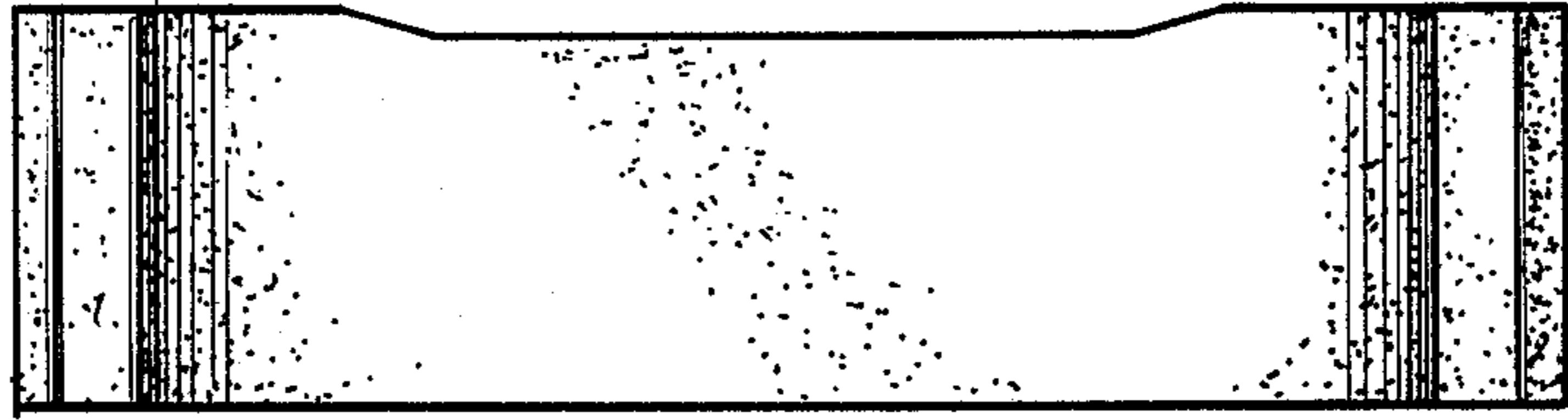

Fig. 4

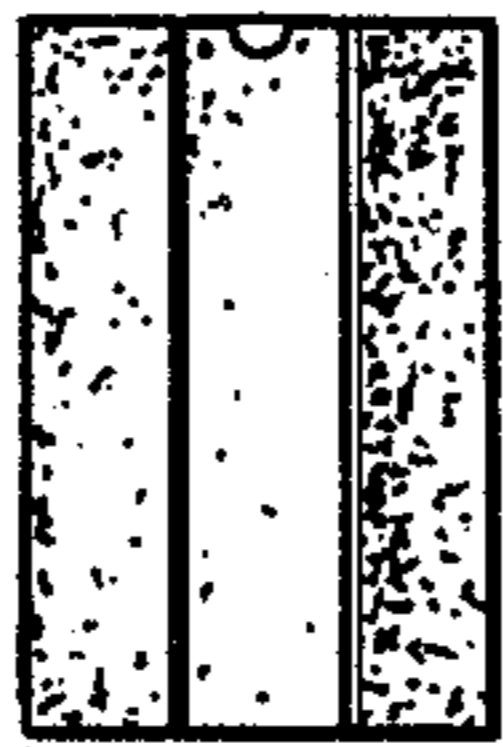

Fig. 5

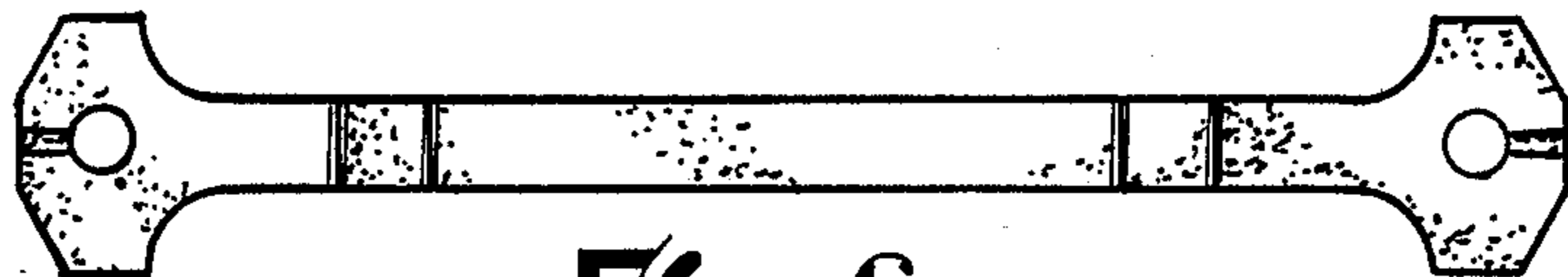

Fig. 6



Fig. 7