

[54] TELEPHONE APPARATUS WITH SPEAKERPHONE AND DISPLAY PANEL

[75] Inventors: Shigeaki Kido; Sadao Isozaki; Yasuko Yajima, all of Tokyo, Japan

[73] Assignee: Meisei Electric Co., Ltd., Japan

[\*\*] Term: 14 Years

[21] Appl. No.: 6,694

[22] Filed: Jan. 22, 1987

[30] Foreign Application Priority Data

Jul. 25, 1986 [JP] Japan ..... 61-29171

Jul. 25, 1986 [JP] Japan ..... 61-29172

[52] U.S. Cl. .... D14/58; D14/62; D14/53; D14/57; D14/52

[58] Field of Search ..... D14/53, 57, 58, 63, D14/64, 62; 379/419, 420, 428, 432, 433, 434, 435, 436, 440, 441

[56] References Cited

U.S. PATENT DOCUMENTS

- D. 275,008 8/1984 Martin ..... D14/53
D. 280,324 5/1985 Endt ..... D14/58 X
D. 282,841 3/1986 Inaba ..... D14/58
D. 284,004 5/1986 Yu ..... D14/58
D. 284,079 6/1986 Kita et al. .... D14/53 X
D. 286,042 10/1986 Fukutani ..... D14/53 X
D. 286,875 11/1986 Cameron ..... D14/53
D. 290,700 7/1987 Lindahl ..... D14/57 X
D. 291,561 8/1987 Nozawa et al. .... D14/57 X
D. 294,022 2/1988 Sekiguchi et al. .... D14/63 X
D. 295,514 5/1988 Inaba ..... D14/58

Primary Examiner—Horace B. Fay
Attorney, Agent, or Firm—Toren, McGeady & Associates

[57] CLAIM

The ornamental design for telephone apparatus with speakerphone and display panel, as shown and described.

DESCRIPTION

FIGS. 1 and 2 are respectively front and rear elevational views of telephone apparatus with speakerphone and display panel showing our new design in cradled relationship;

FIGS. 3 and 4 are respectively left and right side elevational views thereof;

FIGS. 5 and 6 are respectively top and bottom plan views thereof;

FIG. 7 is a top plan view of stand alone and a top view of the handset spaced apart from the stand;

FIG. 8 is a front, top and right side perspective view thereof;

FIGS. 9 and 10 are respectively front and rear elevational views of a second embodiment thereof;

FIGS. 11 and 12 are respectively left and right side elevational views thereof;

FIGS. 13 and 14 are respectively top and bottom plan views thereof;

FIG. 15 is a top plan view of the stand alone and a top view of the handset spaced apart from the stand; and

FIG. 16 is a top, front and right side perspective view of the second embodiment shown in FIGS. 9-15.

The broken line showing of a telephone cord is for illustrative purposes only and forms no part of the claimed design.

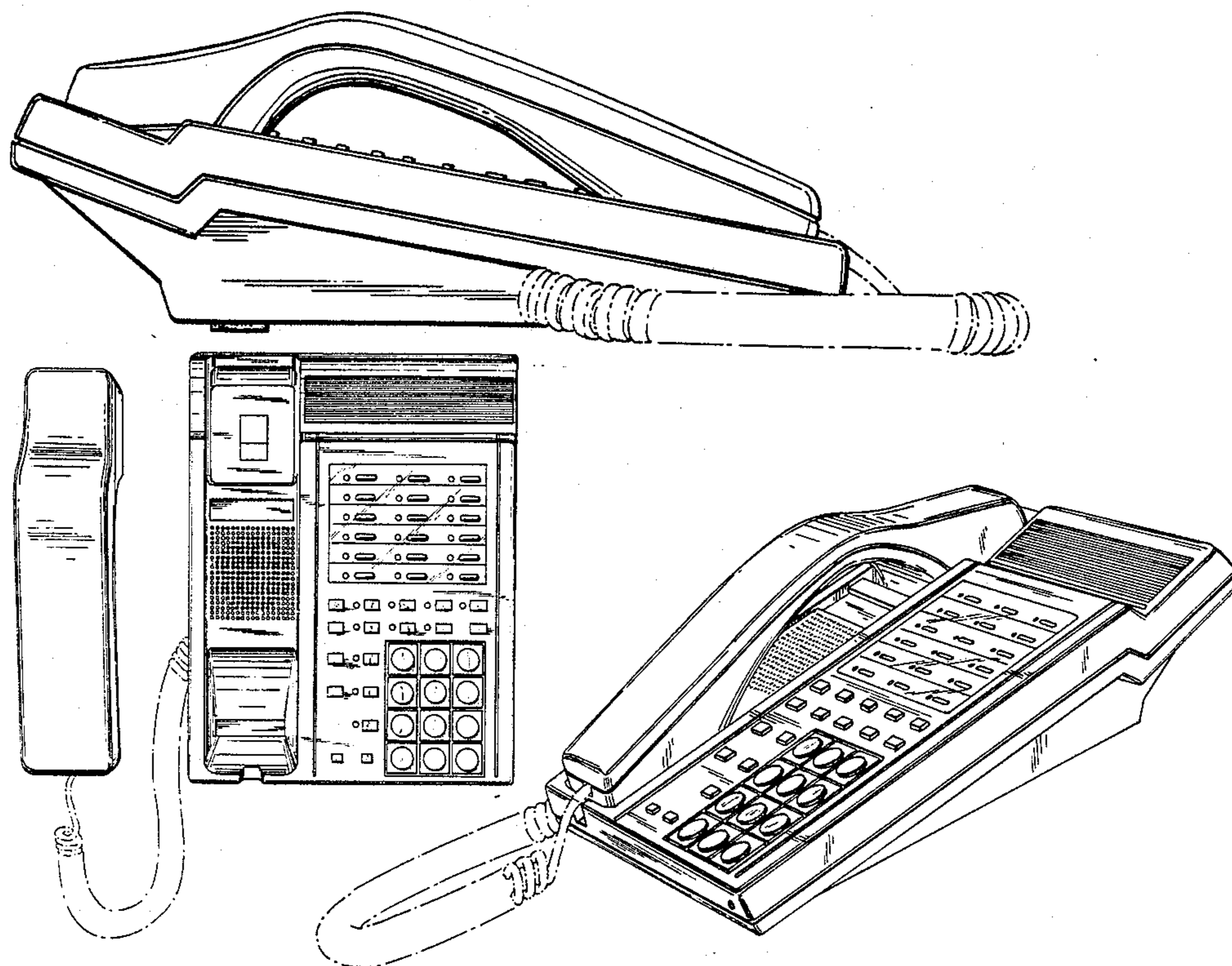

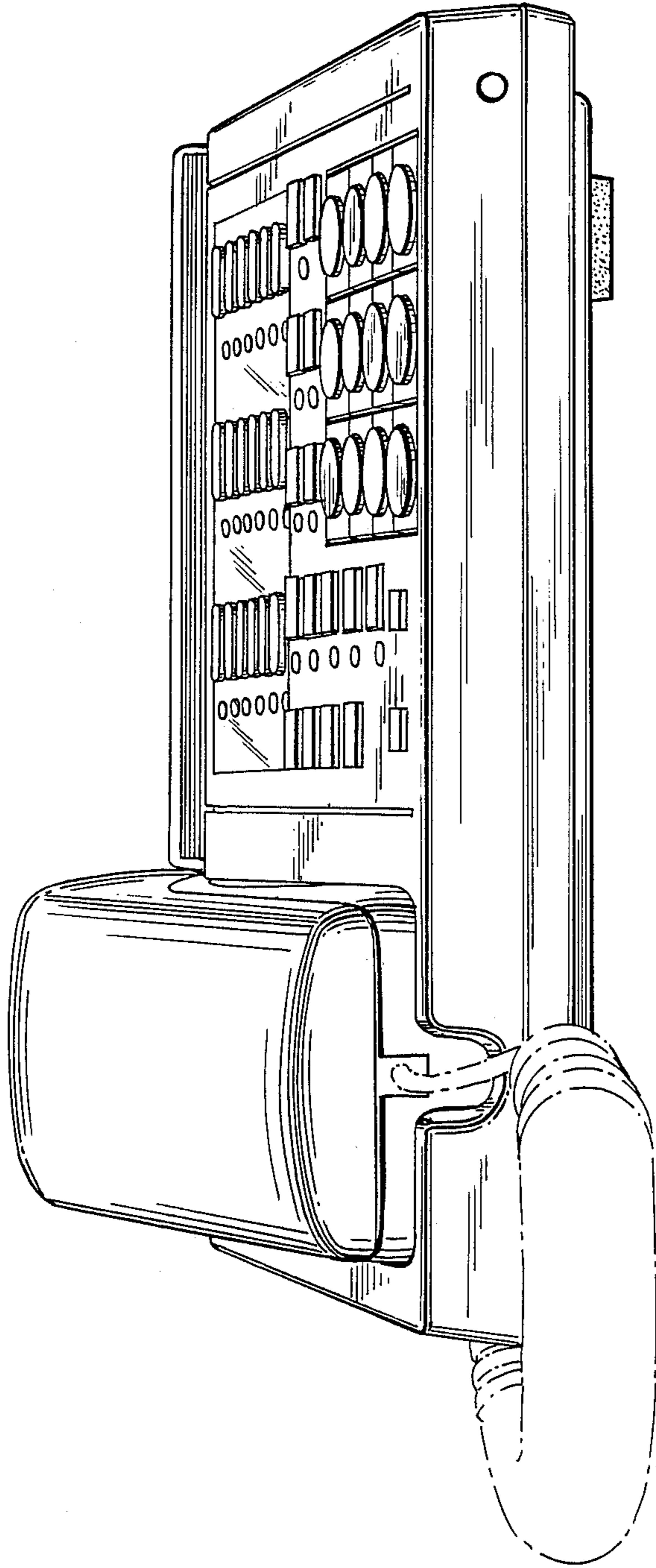

FIG. 1

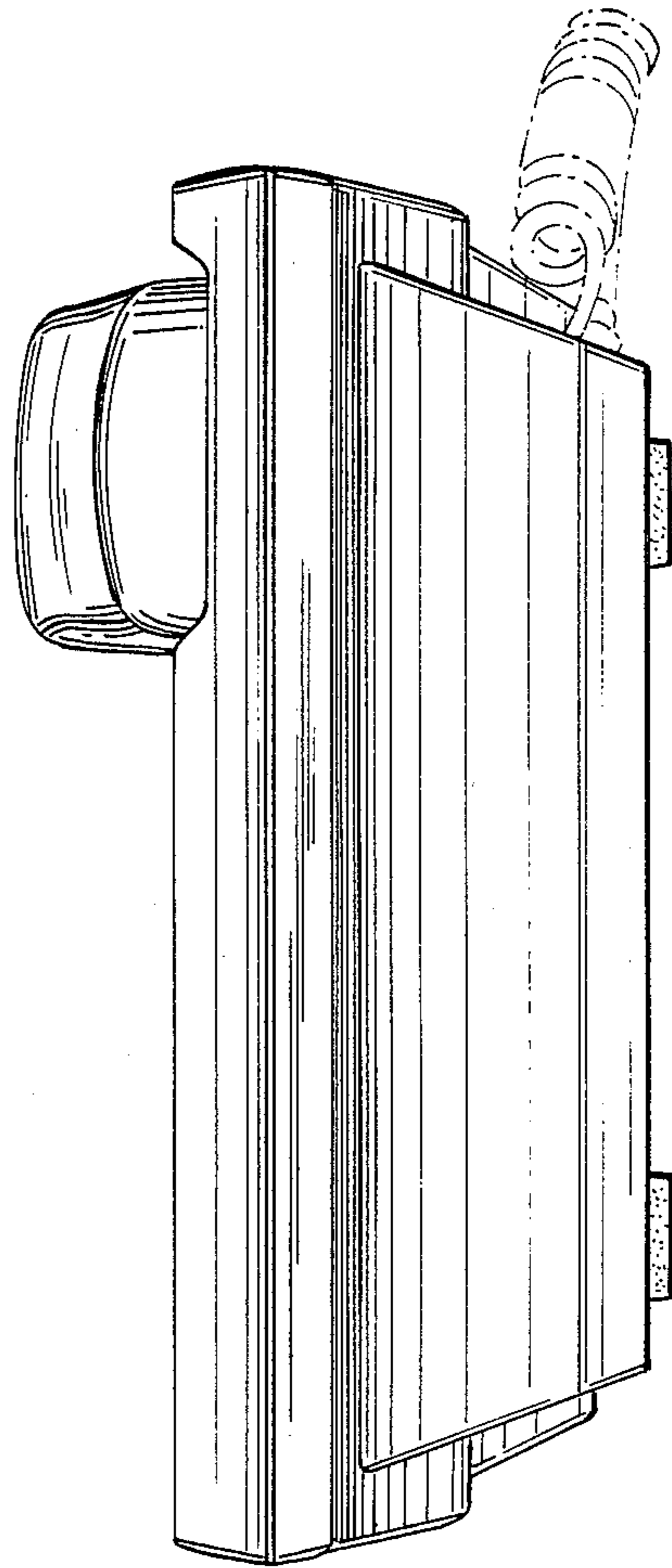

FIG. 2



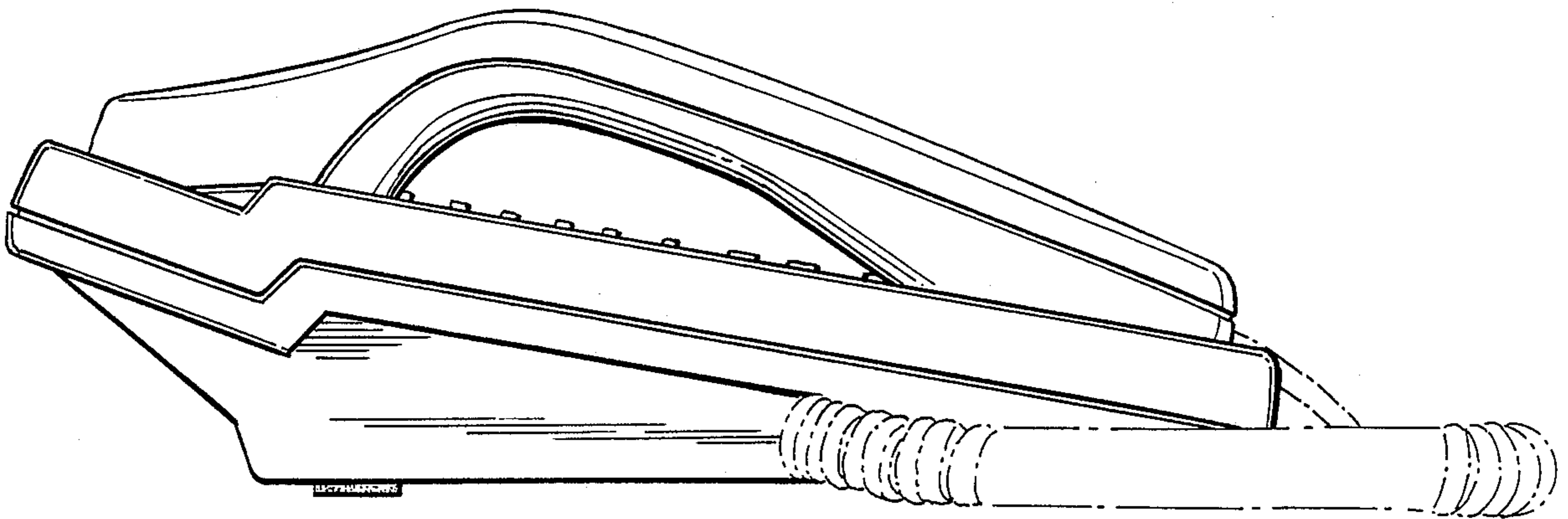

FIG. 3

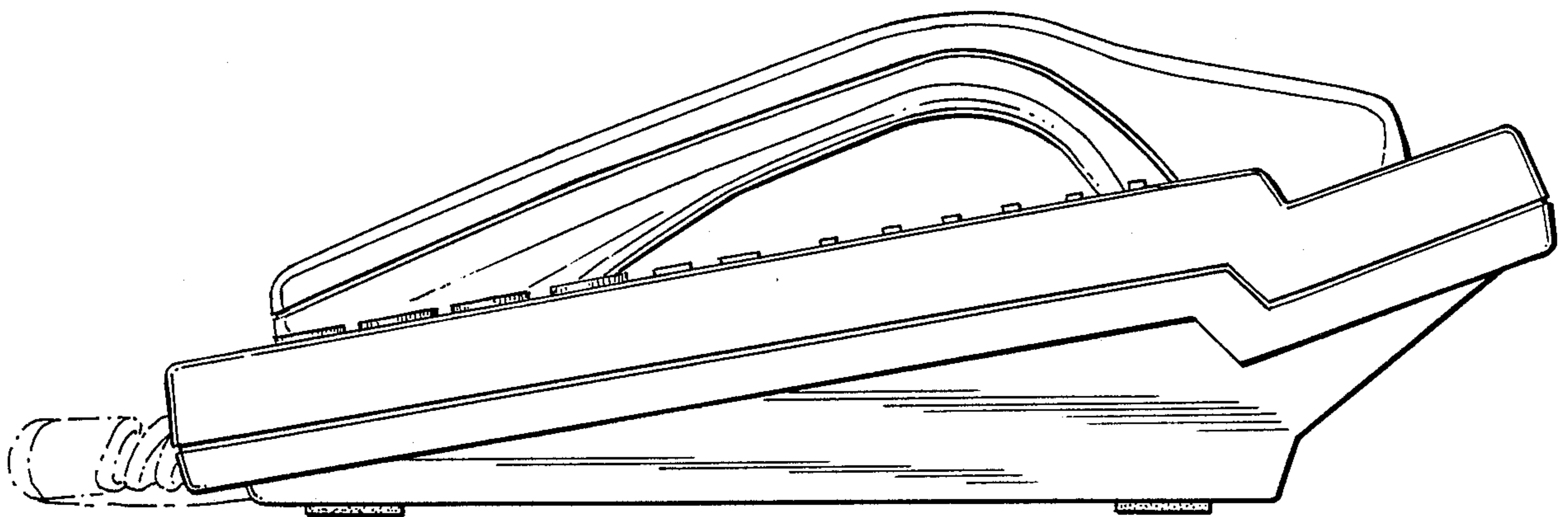

FIG. 4

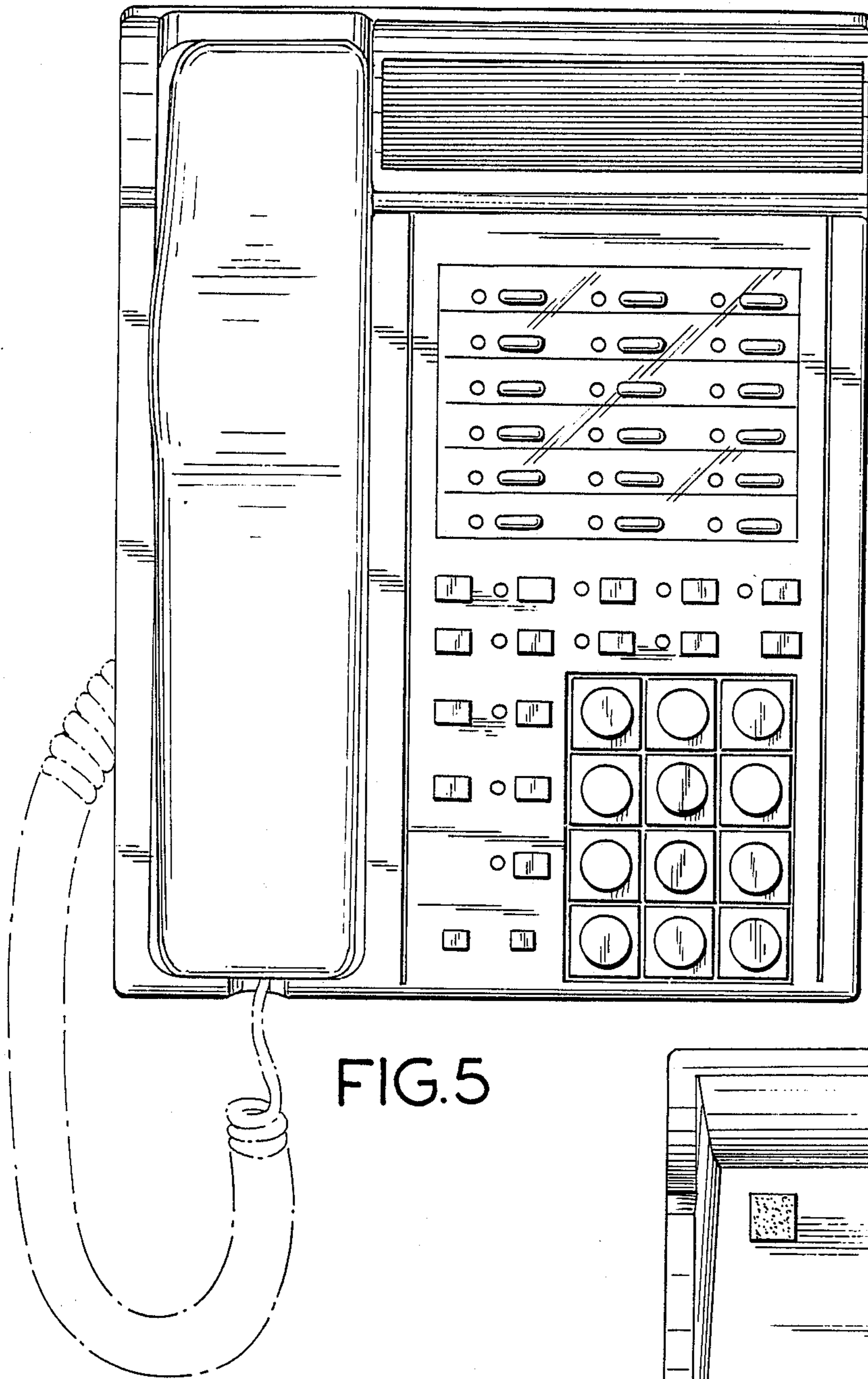

FIG. 5

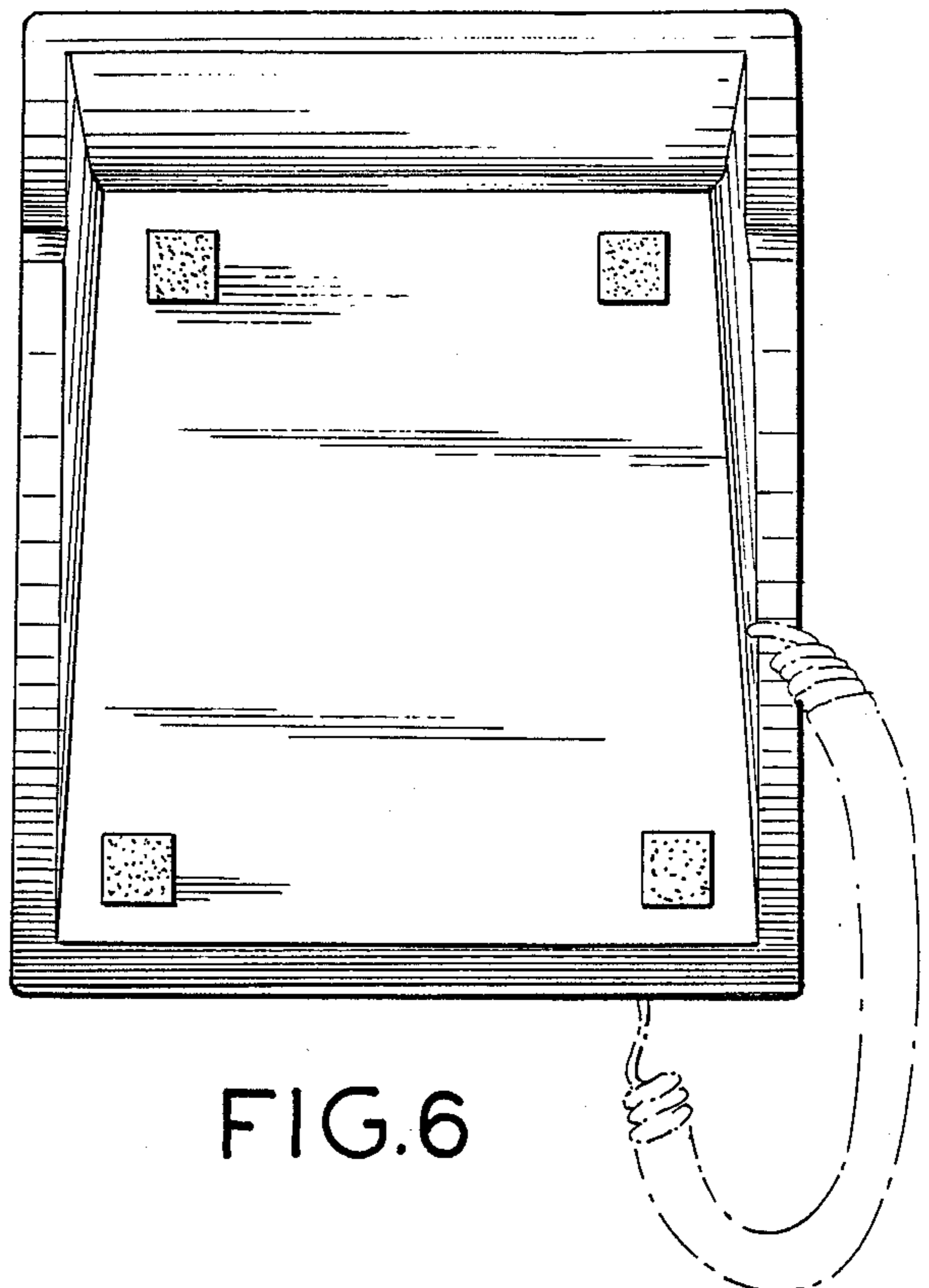

FIG. 6

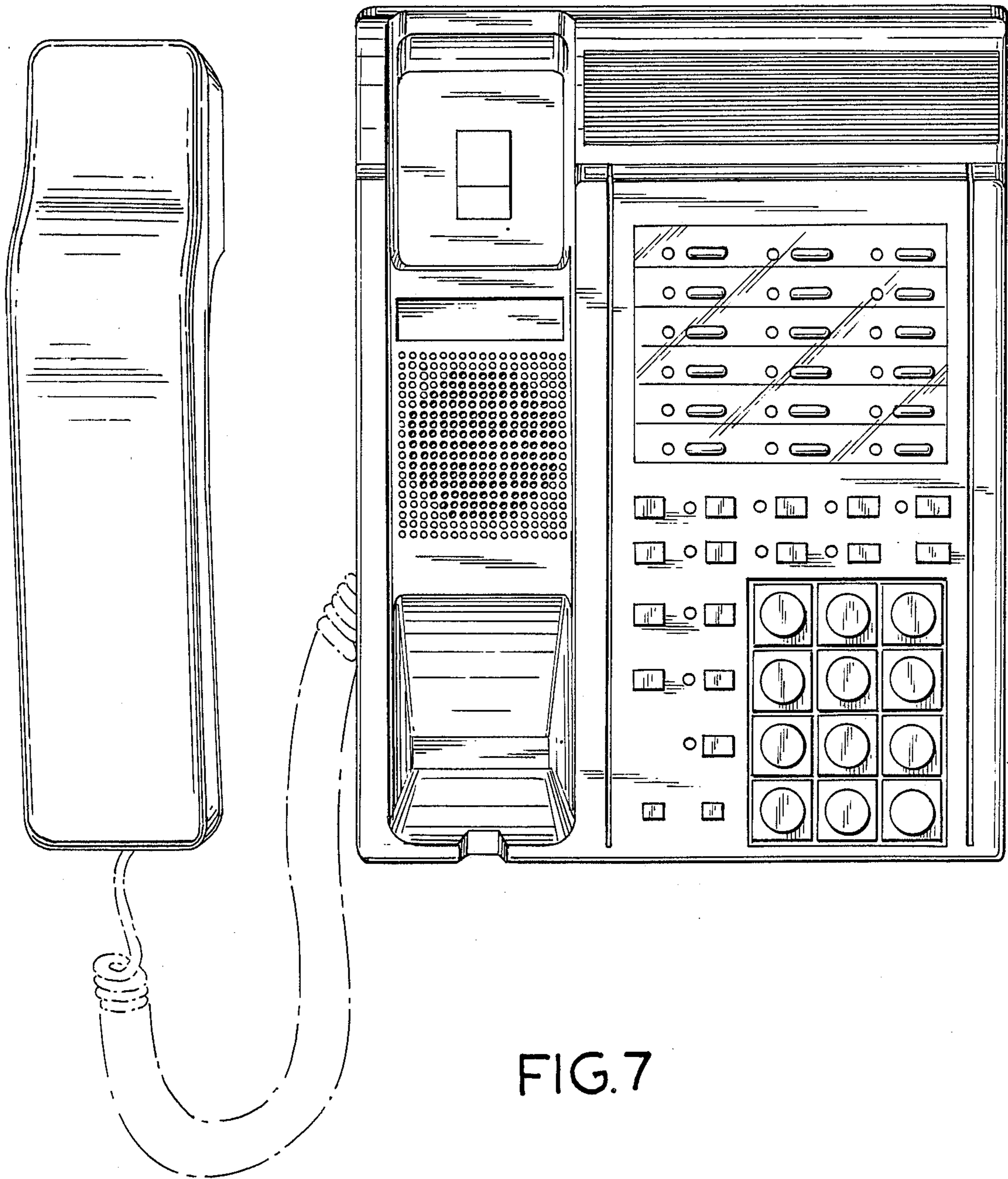

FIG. 7



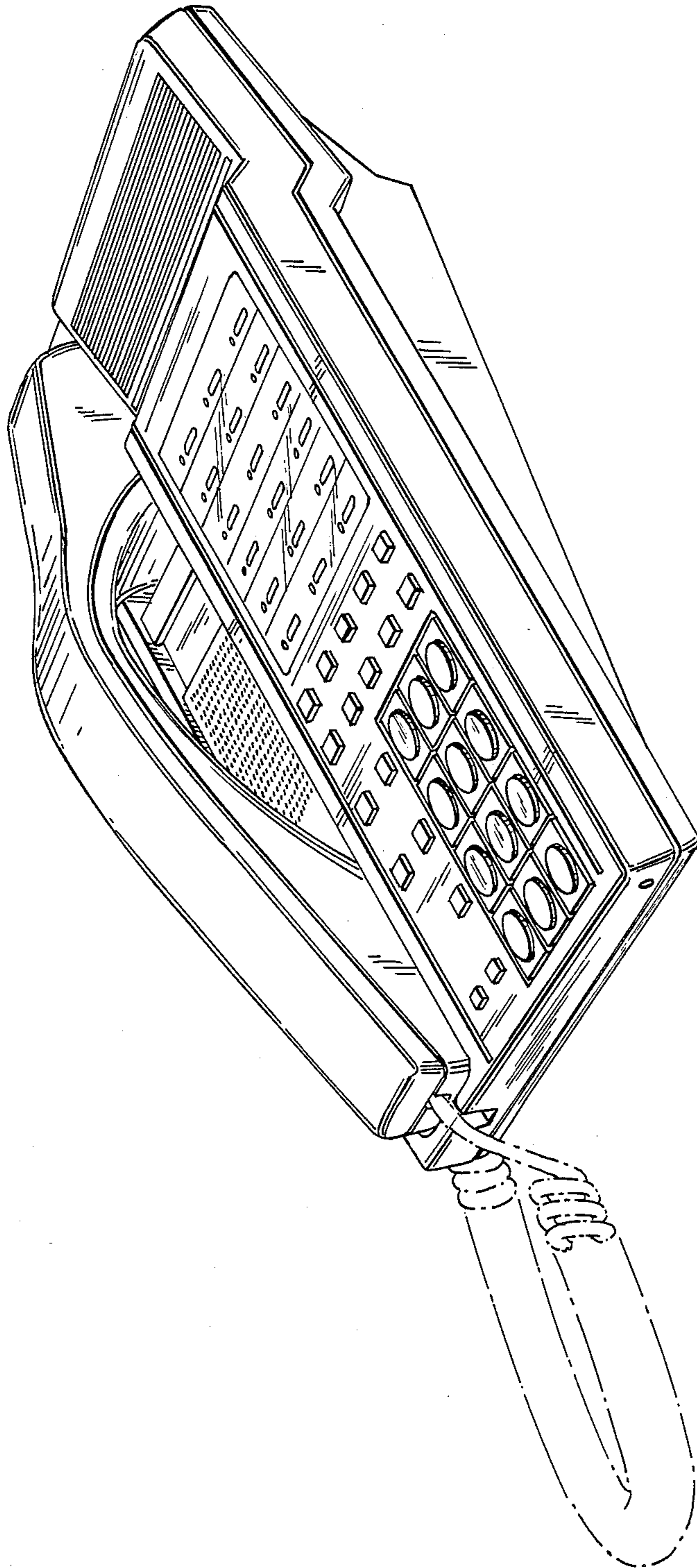

FIG.8

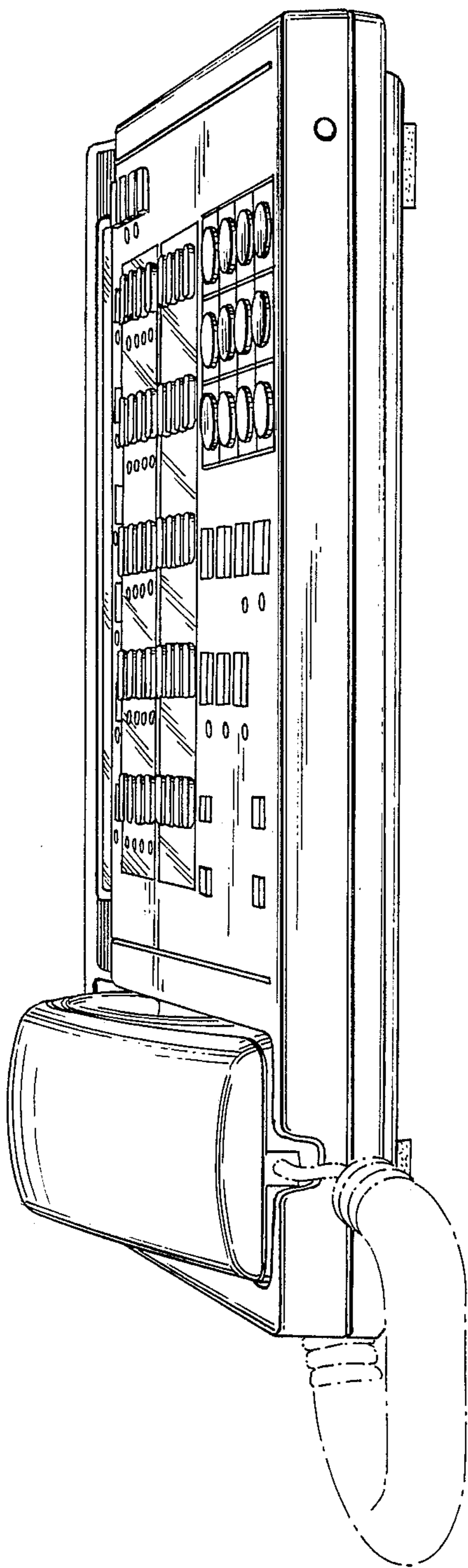

FIG. 9

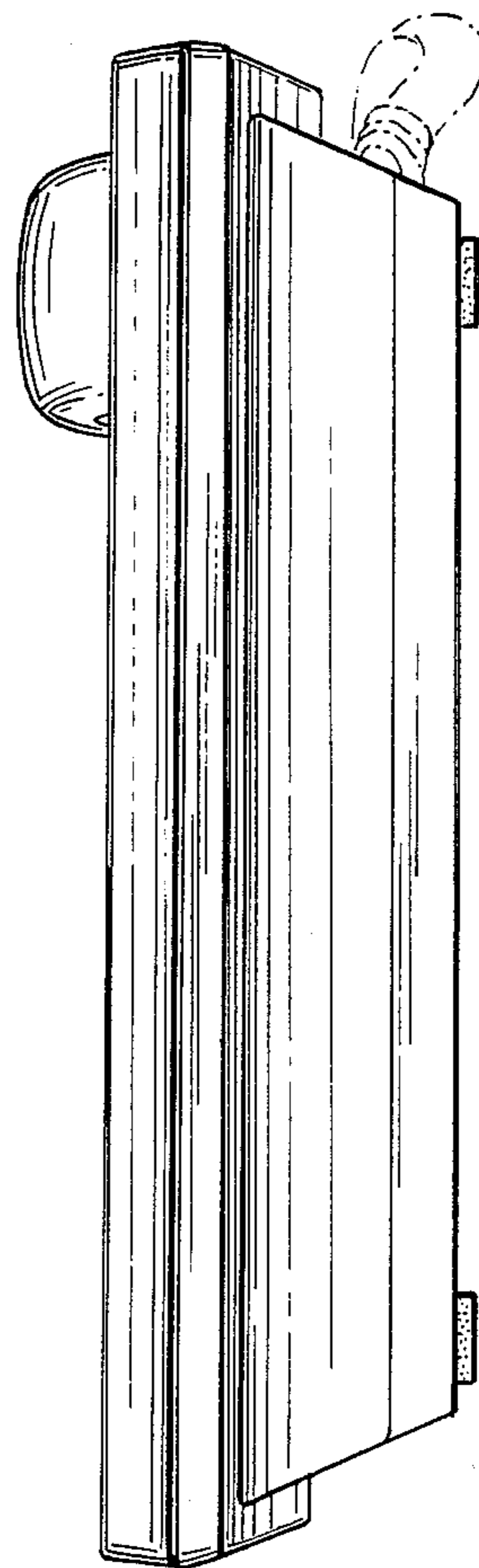

FIG. 10

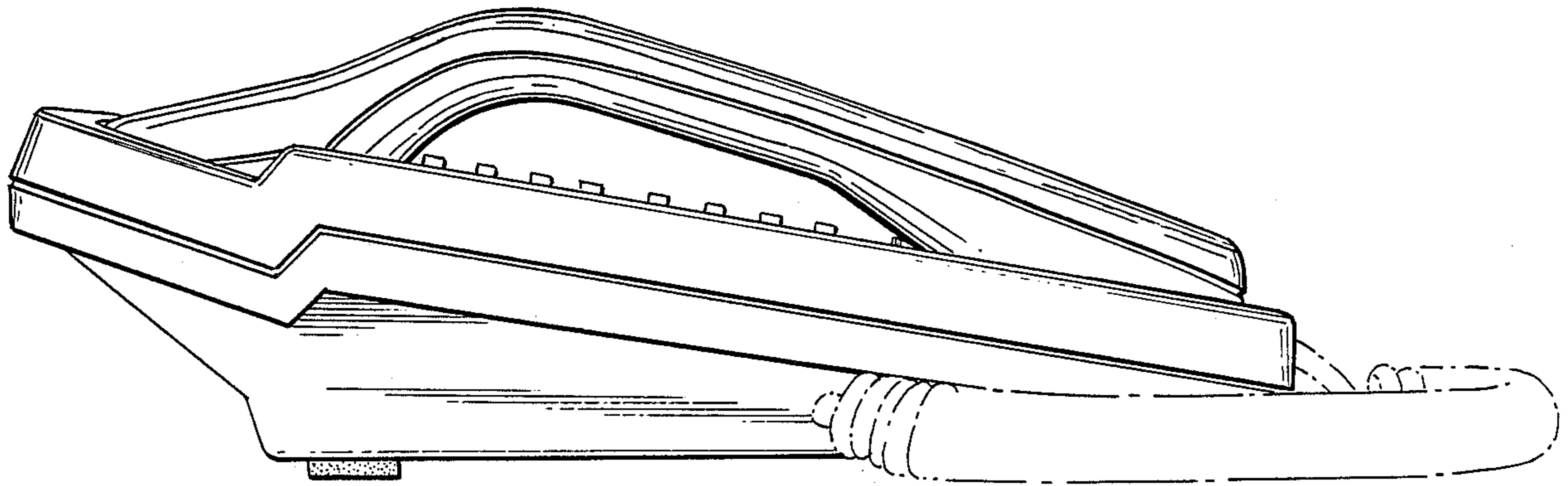

FIG. 11

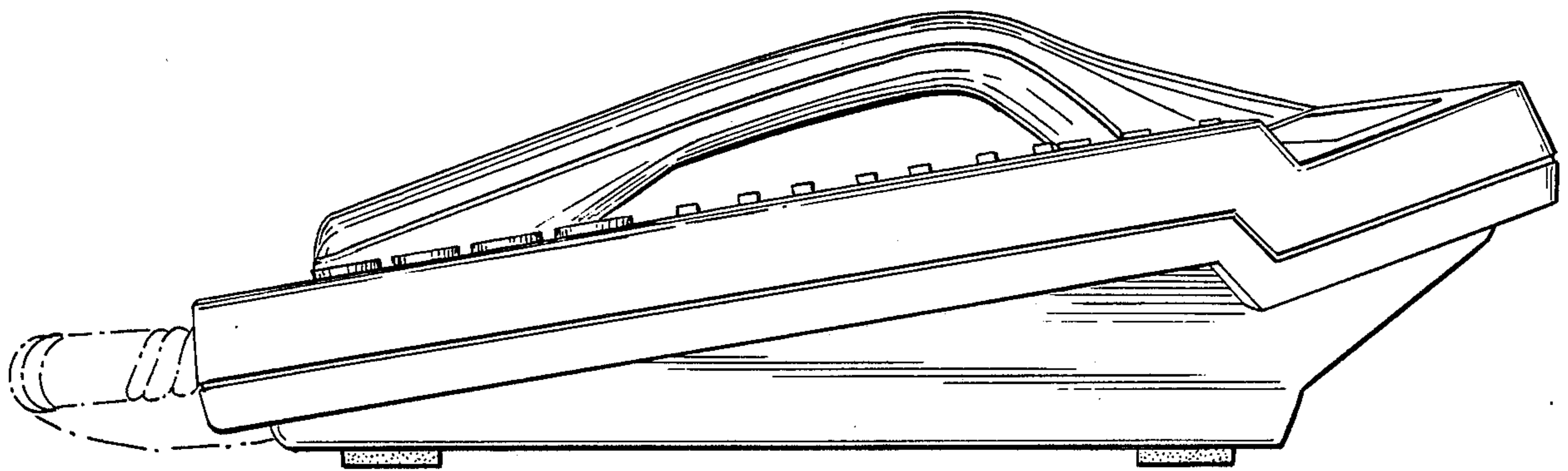

FIG. 12



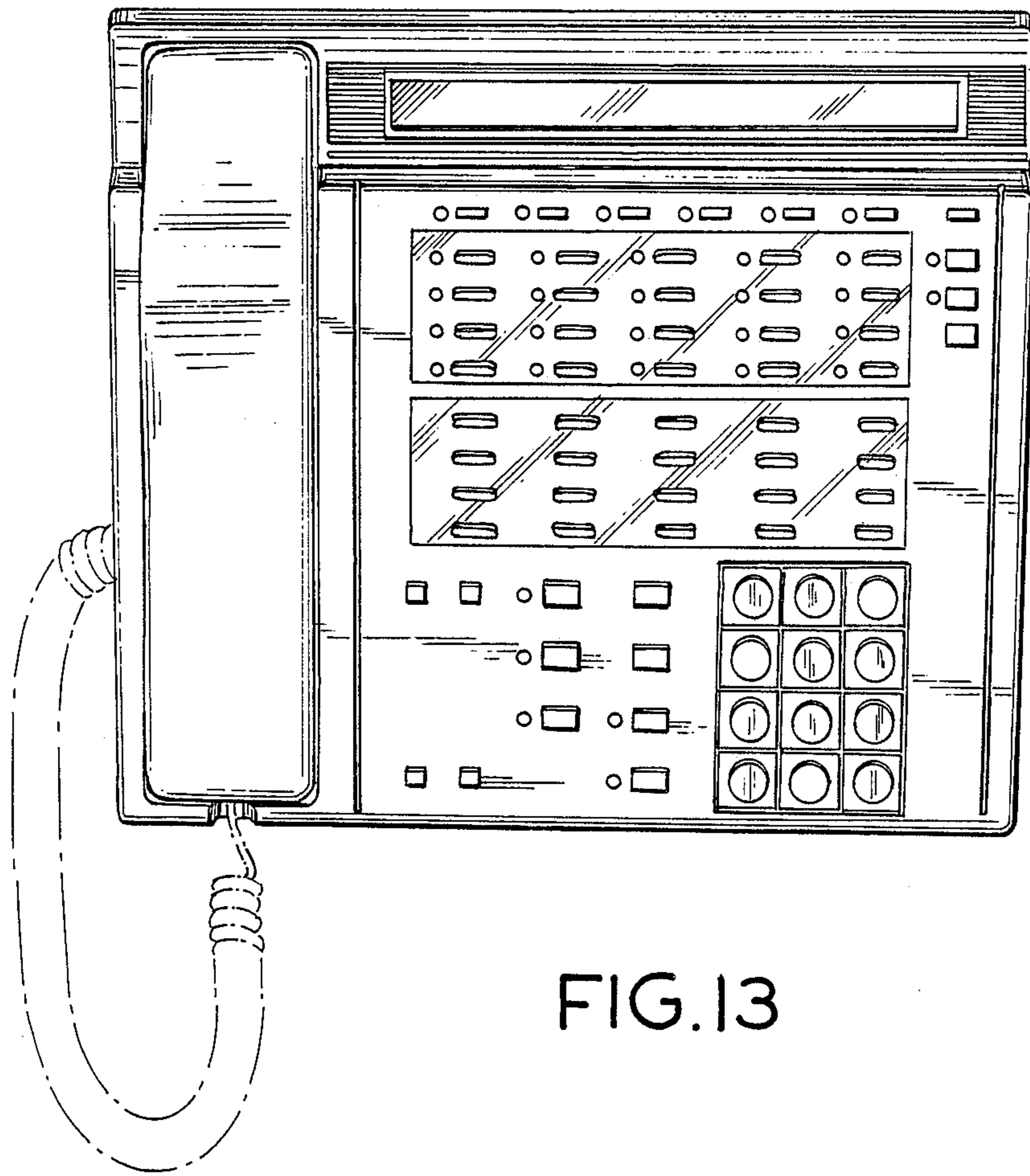

FIG. 13

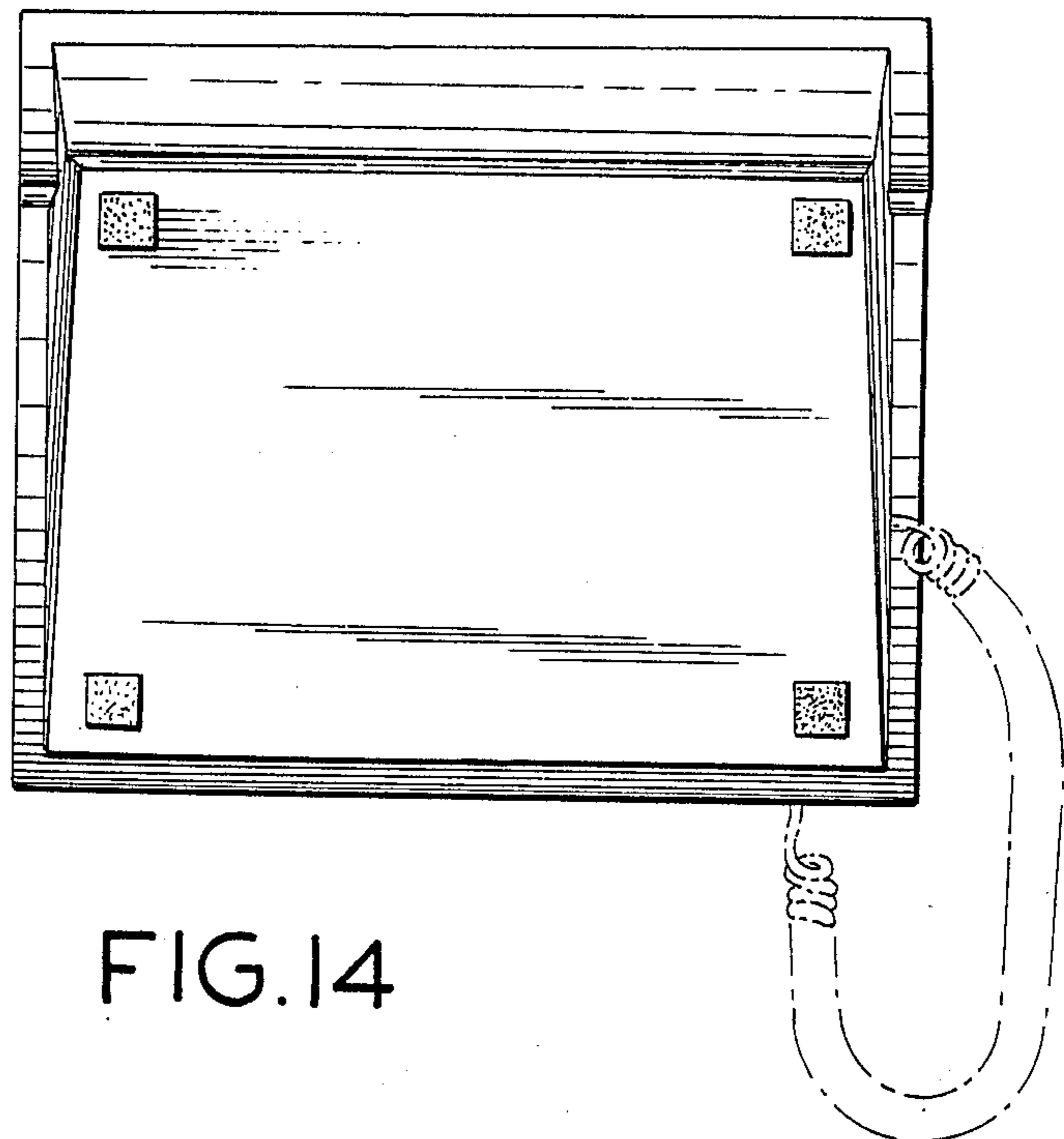

FIG. 14

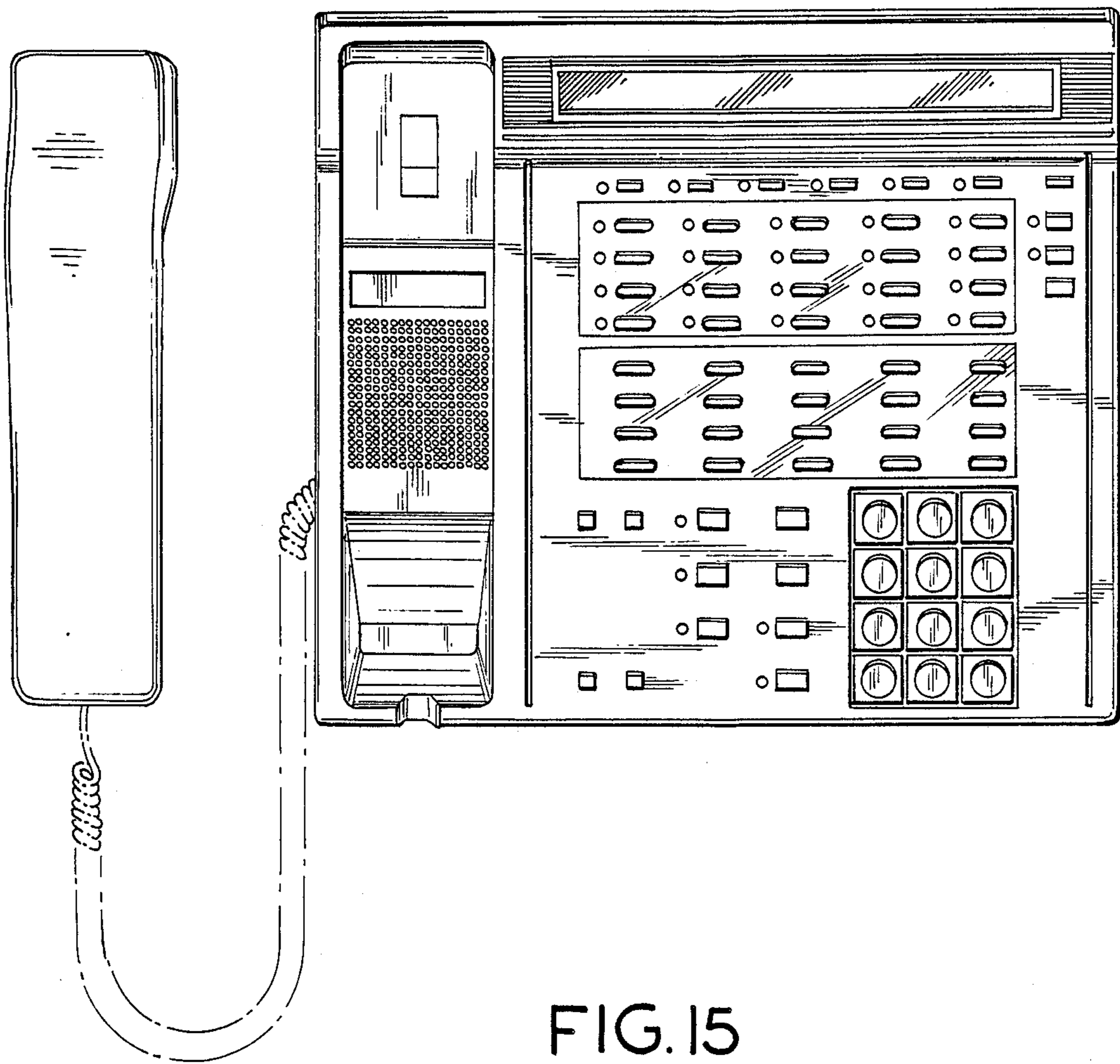

FIG. 15

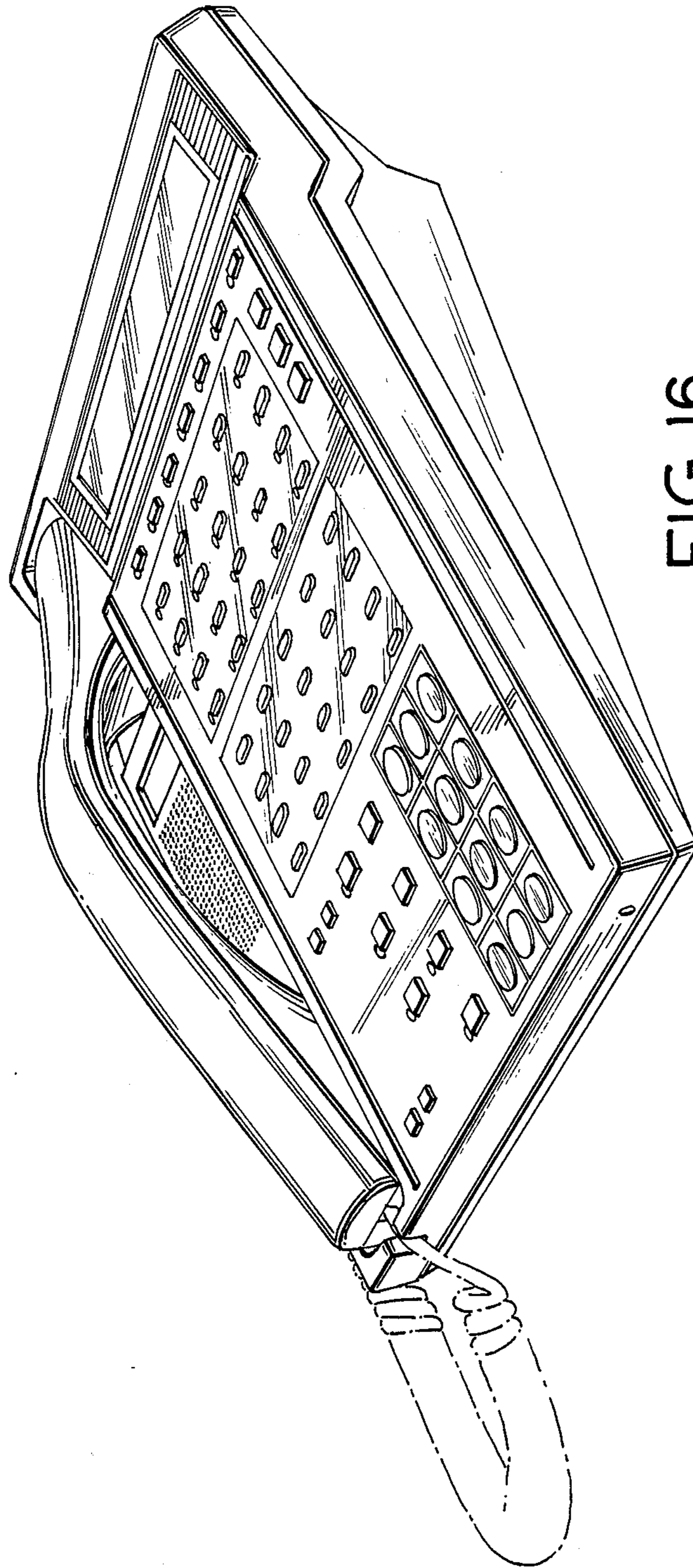

FIG. 16