

[54] COMBINED DISPLAY RACK AND HOLDER

D. 286,600 11/1986 Meyer et al. D6/573

[76] Inventor: Steven Kruzel, 1543 N. Prospect Rd., Ypsilanti, Mich. 48197

Primary Examiner—Carmen H. Vales
Attorney, Agent, or Firm—James M. Deimen

[**] Term: 14 Years

[57] CLAIM

[21] Appl. No.: 806,550

The ornamental design for a combined display rack and holder, as shown and described.

[22] Filed: Dec. 9, 1985

[52] U.S. Cl. D6/449

DESCRIPTION

[58] Field of Search D6/449, 475, 573, 574; 211/13

FIG. 1 is a front elevational view of a combined display rack and holder showing my new design; FIG. 2 is a rear elevational view thereof; FIG. 3 is a right side elevational view thereof; FIG. 4 is a left side elevational view thereof; FIG. 5 is a top plan view thereof; FIG. 6 is a bottom plan view thereof; and FIG. 7 is a perspective view thereof.

[56] References Cited

U.S. PATENT DOCUMENTS

- D. 185,897 8/1959 Stark D6/574
- D. 194,581 2/1963 Thompson, Jr. D6/573
- D. 195,668 7/1963 Thompson D6/573

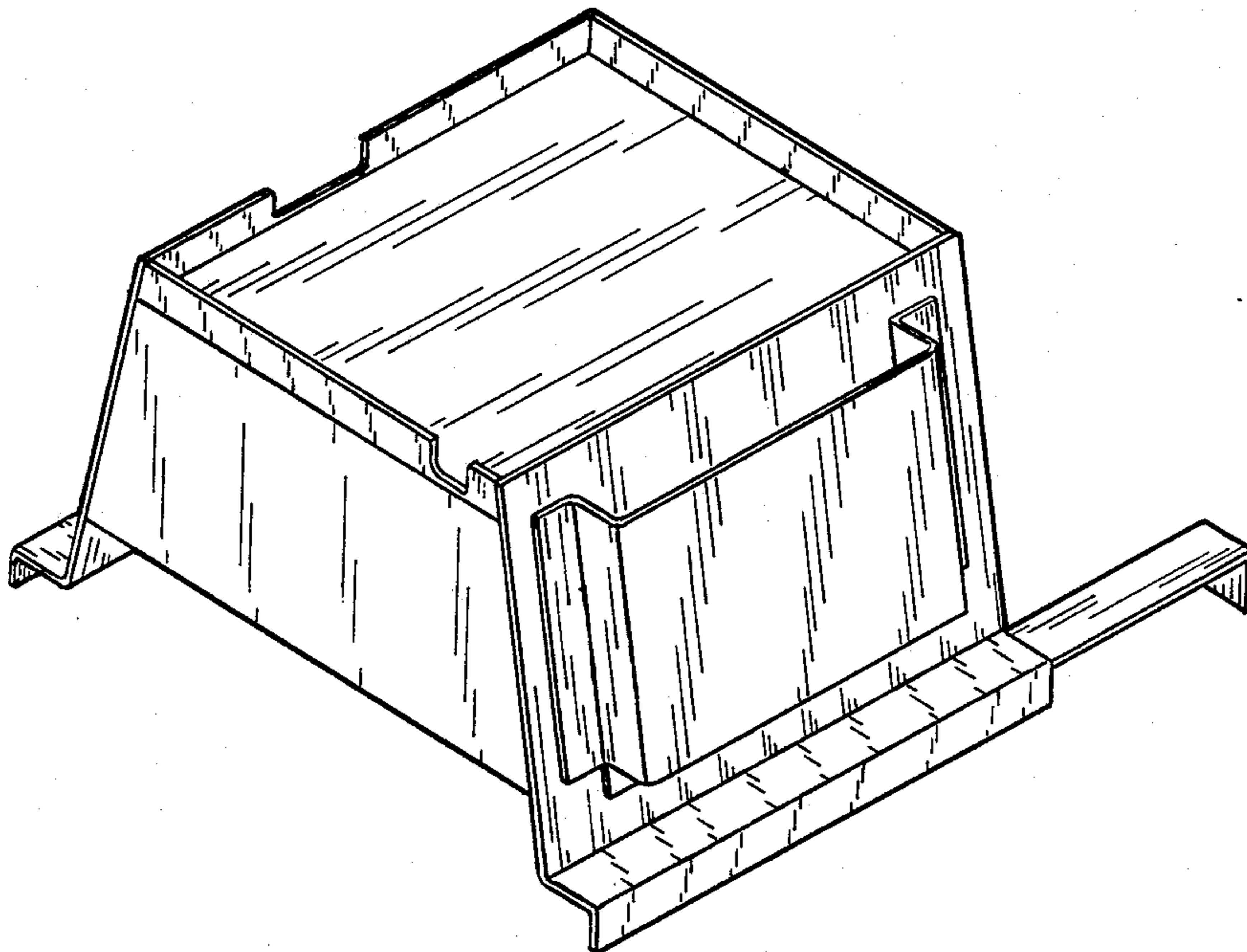

FIG. 1

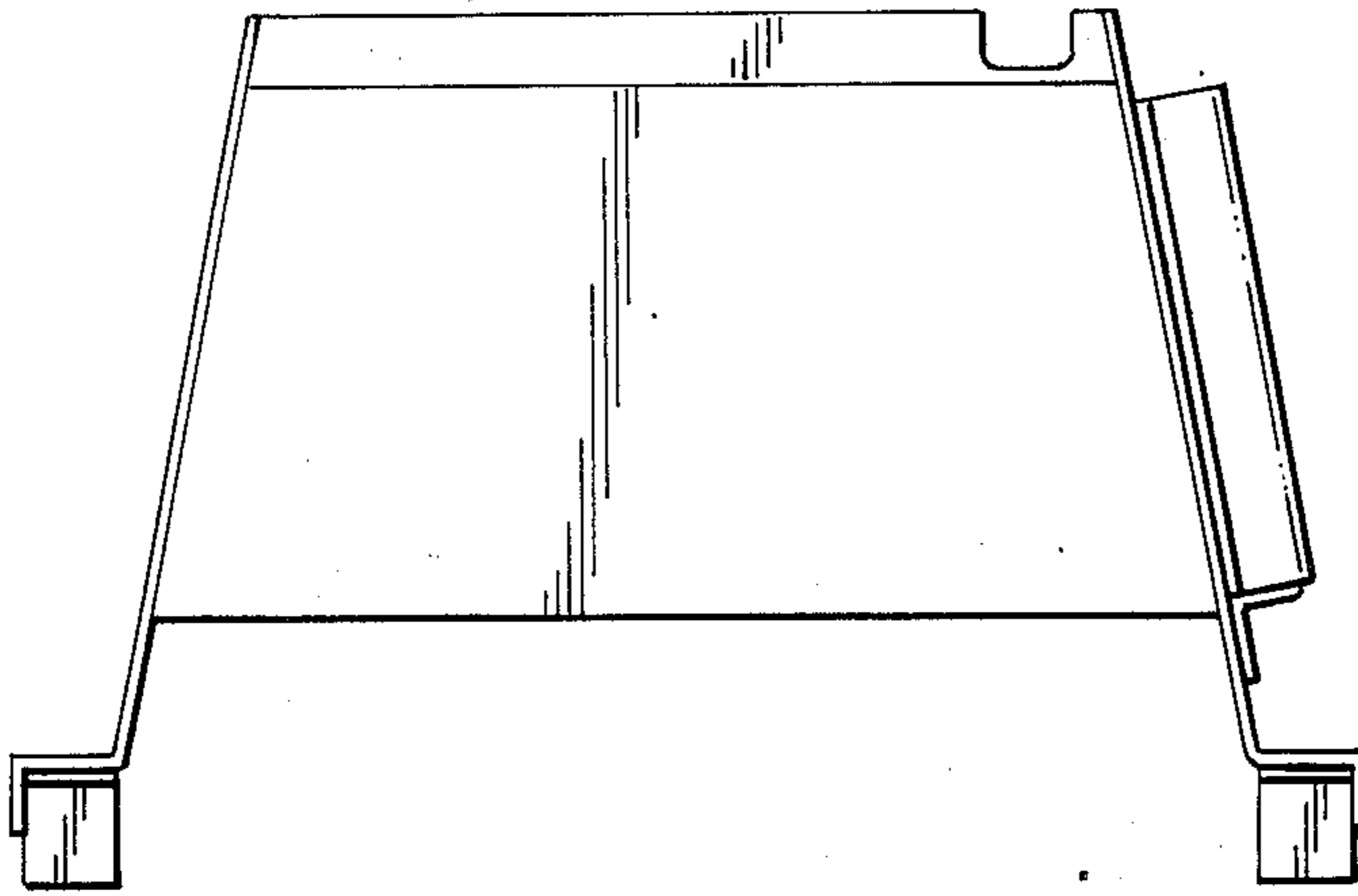

FIG. 2

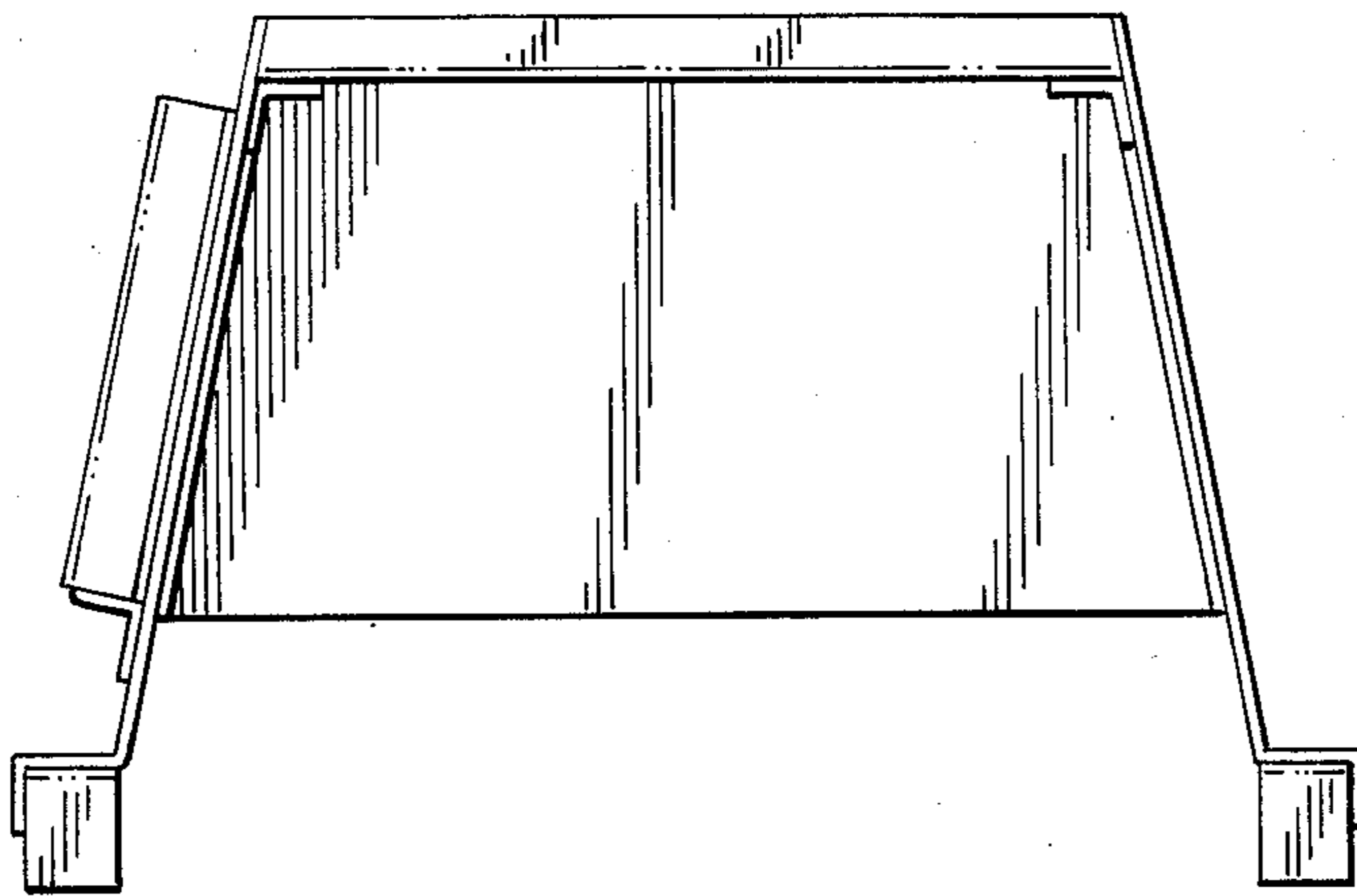

FIG. 3

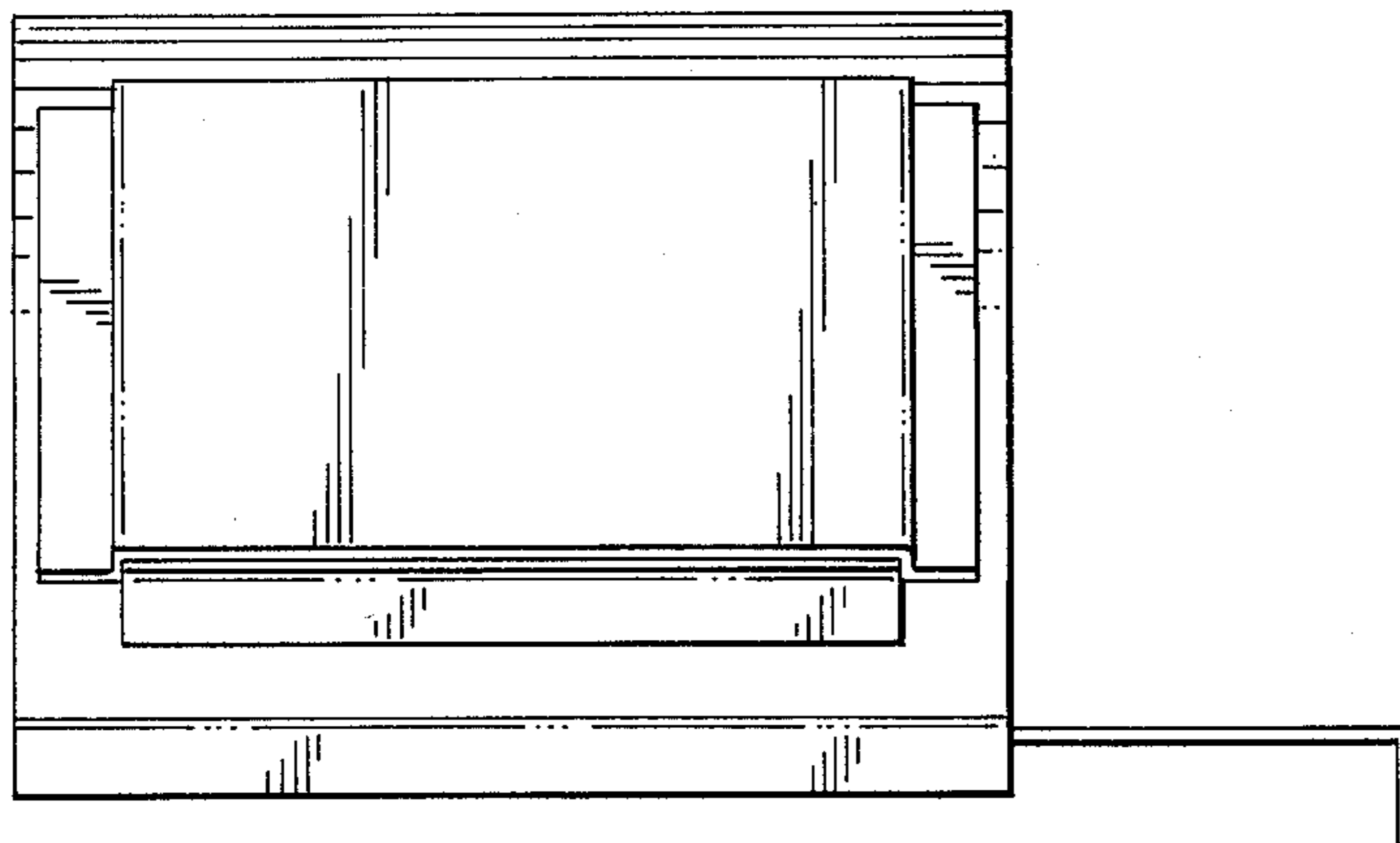

FIG. 4

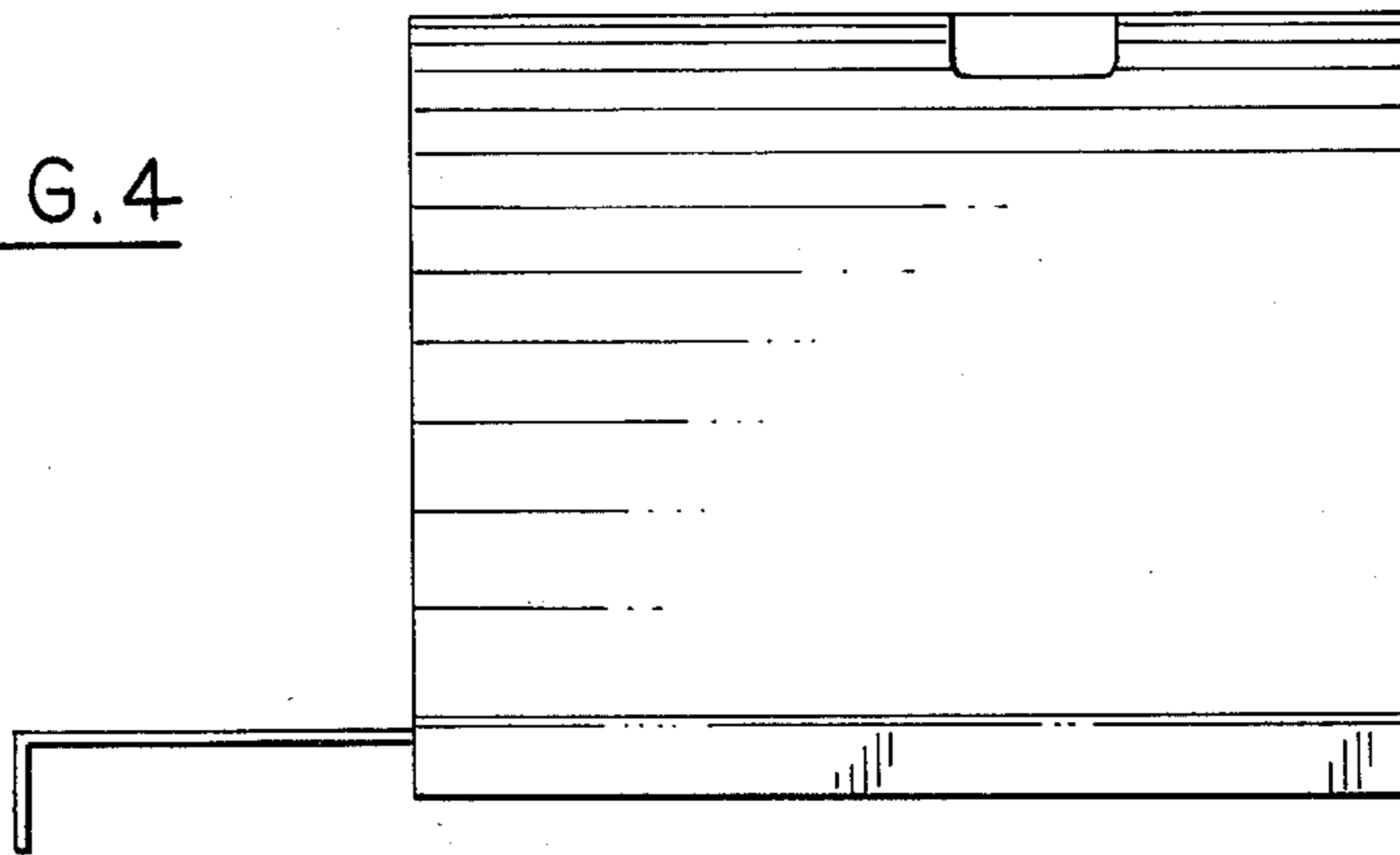

FIG. 5

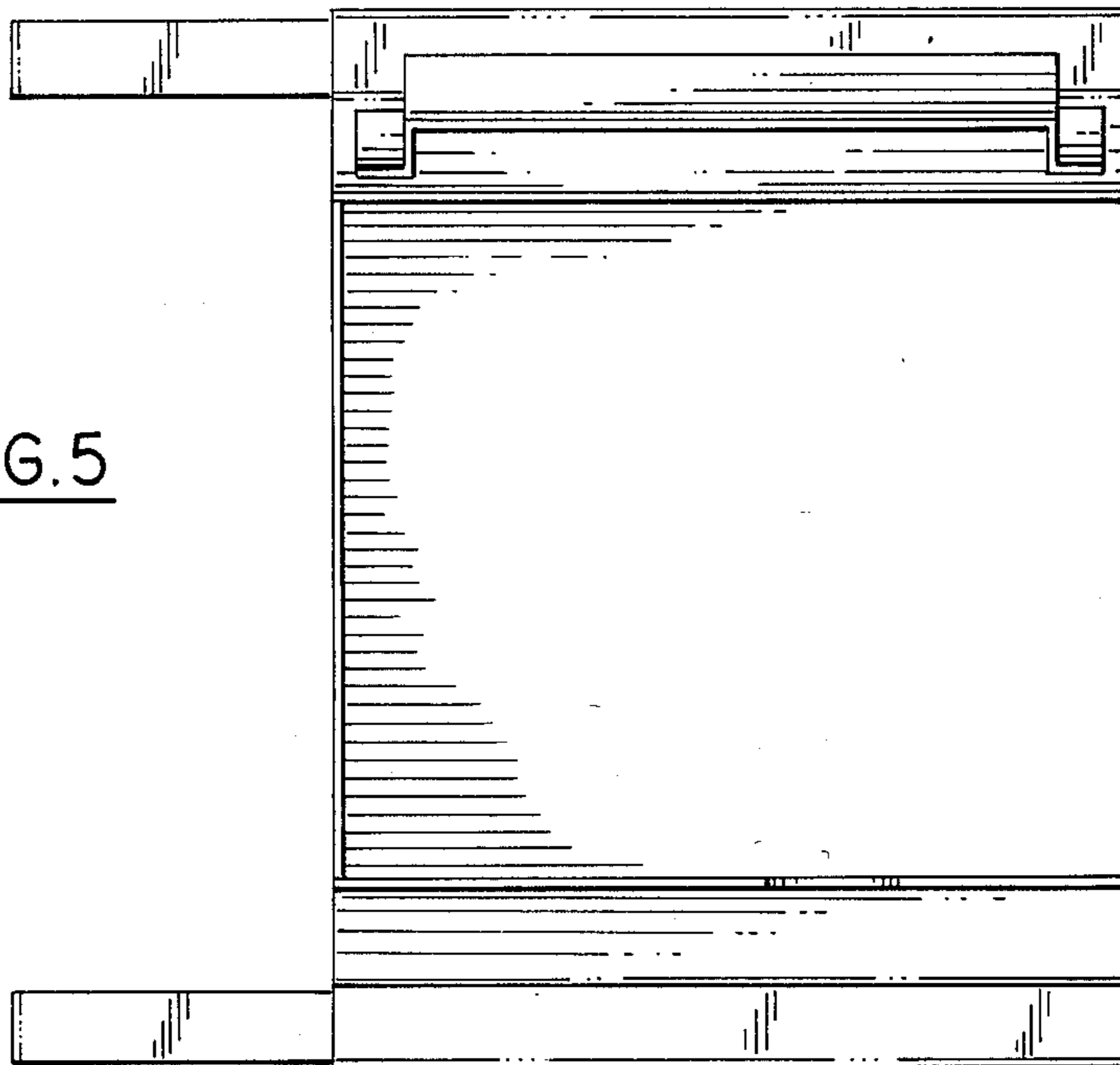

FIG. 6

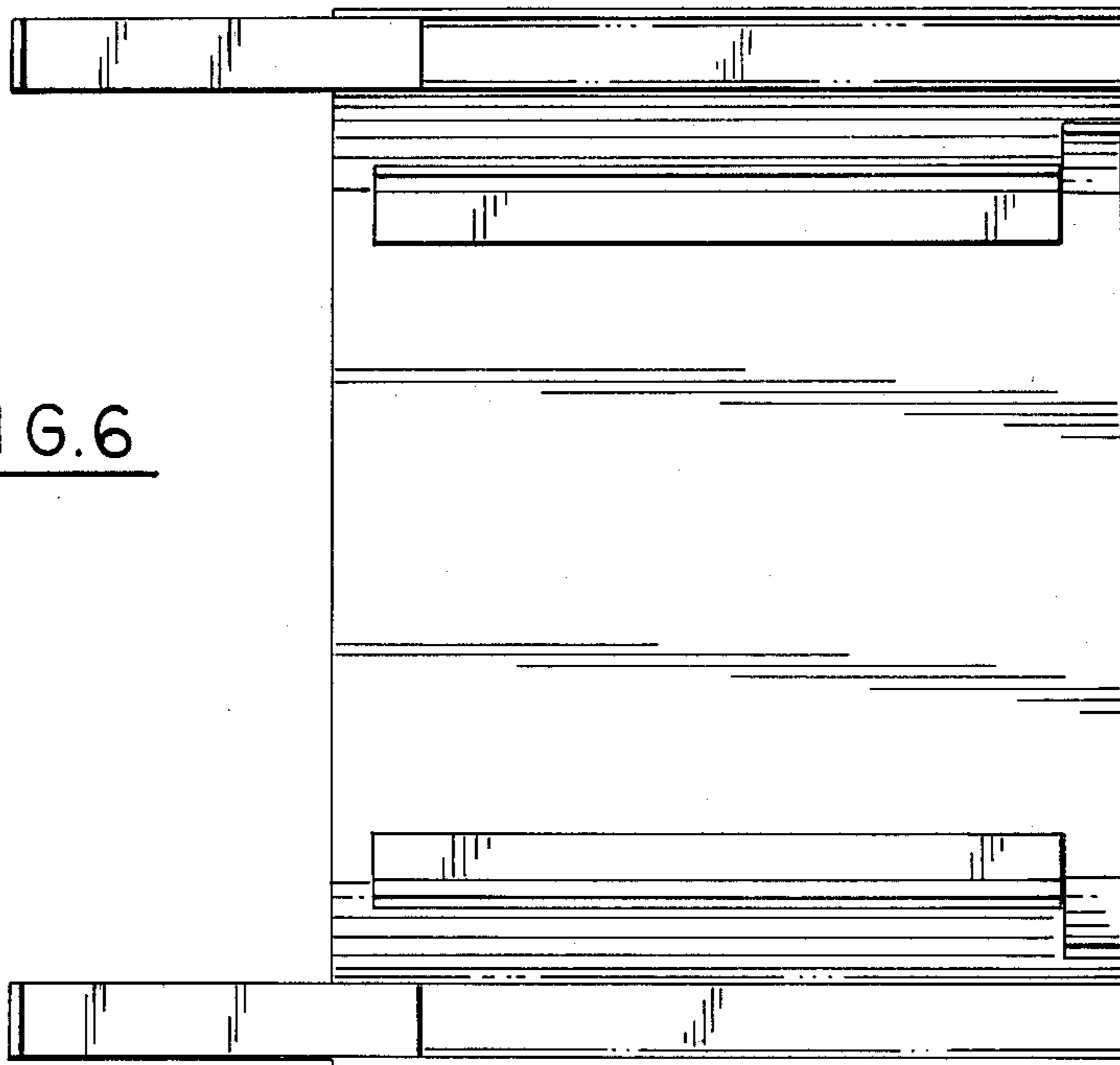

FIG. 7

