

[54] GARMENT HANGER

[75] Inventor: Ronald M. Wilson, Black Rock, Australia

[73] Assignee: Spotless Plastics Limited, Victoria, Australia

[**] Term: 14 Years

[21] Appl. No.: 852,883

[22] Filed: Apr. 15, 1986

[30] Foreign Application Priority Data

Oct. 17, 1985 [AU] Australia 2966/85
[52] U.S. Cl. D6/326
[58] Field of Search D6/315-319, D6/326, 327, 328, 513; 211/13, 113; 223/85, 87, 88, 91, 95, 96, 92, 93

[56] References Cited

U.S. PATENT DOCUMENTS

D. 283,854 5/1986 Marshall D6/318
4,194,274 3/1980 Garrison 223/91

Primary Examiner—B. J. Bullock
Attorney, Agent, or Firm—Scully, Scott, Murphy & Presser

[57] CLAIM

The ornamental design for a garment hanger, as shown and described.

DESCRIPTION

FIG. 1 is a front perspective view of a garment hanger showing my new design;
FIG. 2 is a front perspective view of a second embodiment of the design of FIG. 1, the only difference being an increase in length;
FIG. 3 is a perspective view of a third embodiment of the design of FIG. 1, the only difference being a further increase in length;
FIG. 4 is a rear, bottom perspective view of FIG. 1;
FIG. 5 is as rear, bottom perspective view of FIG. 2;
FIG. 6 is a rear, bottom perspective view of FIG. 3;
FIG. 7 is a front elevational view of FIG. 1;
FIG. 8 is a front elevational view of FIG. 2;
FIG. 9 is a front elevational view of FIG. 3;
FIG. 10 is a left side elevational view of all the embodiments, with the clamping jaw closed;
FIG. 11 is a left side elevational view of all the embodiments with the clamping jaw opened;
FIG. 12 is a fragmentary perspective view of the opened clamping jaw;
FIG. 13 is a fragmentary perspective view of the clamping jaw with the spring clip removed.

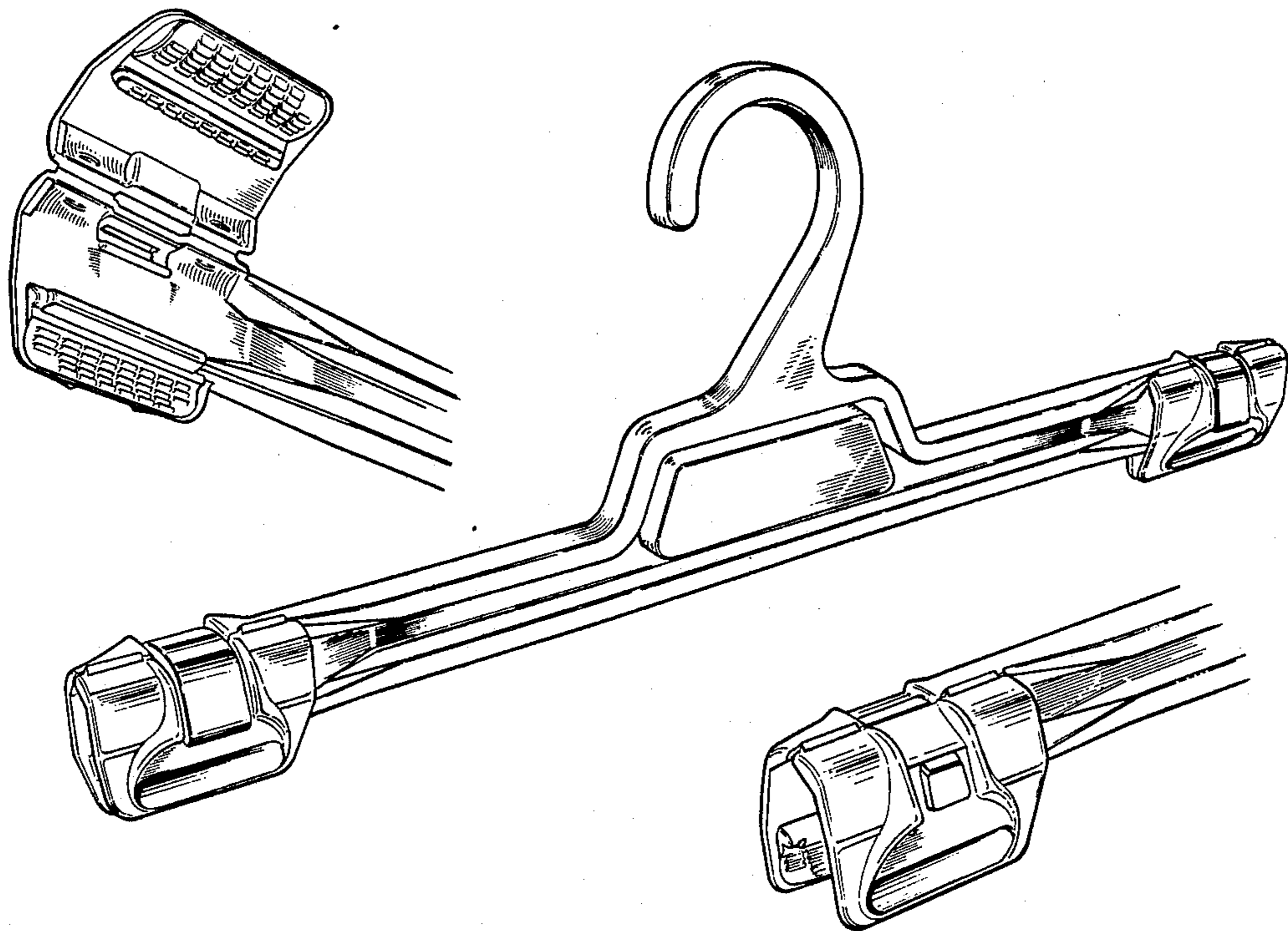

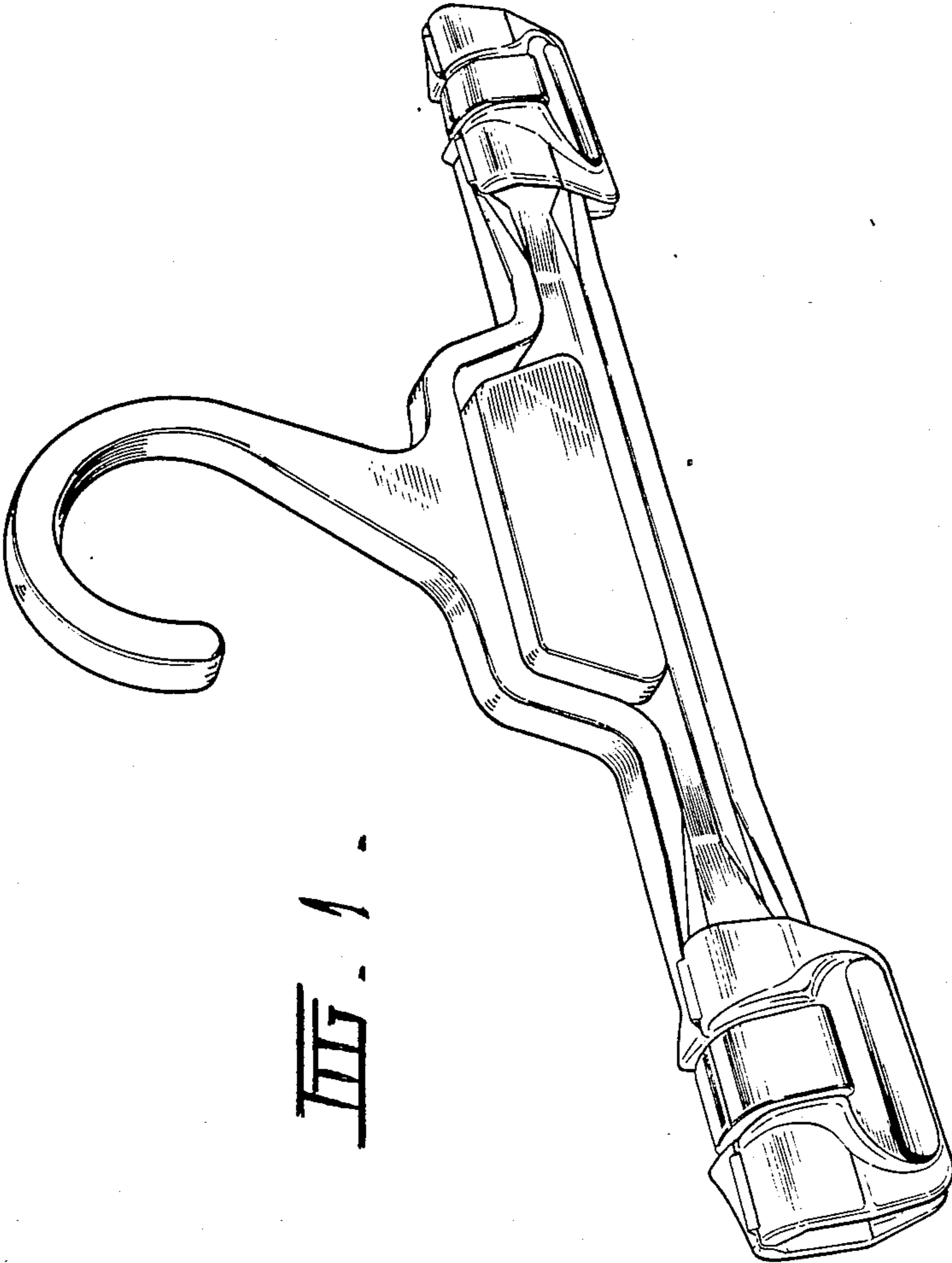

FIG. 1

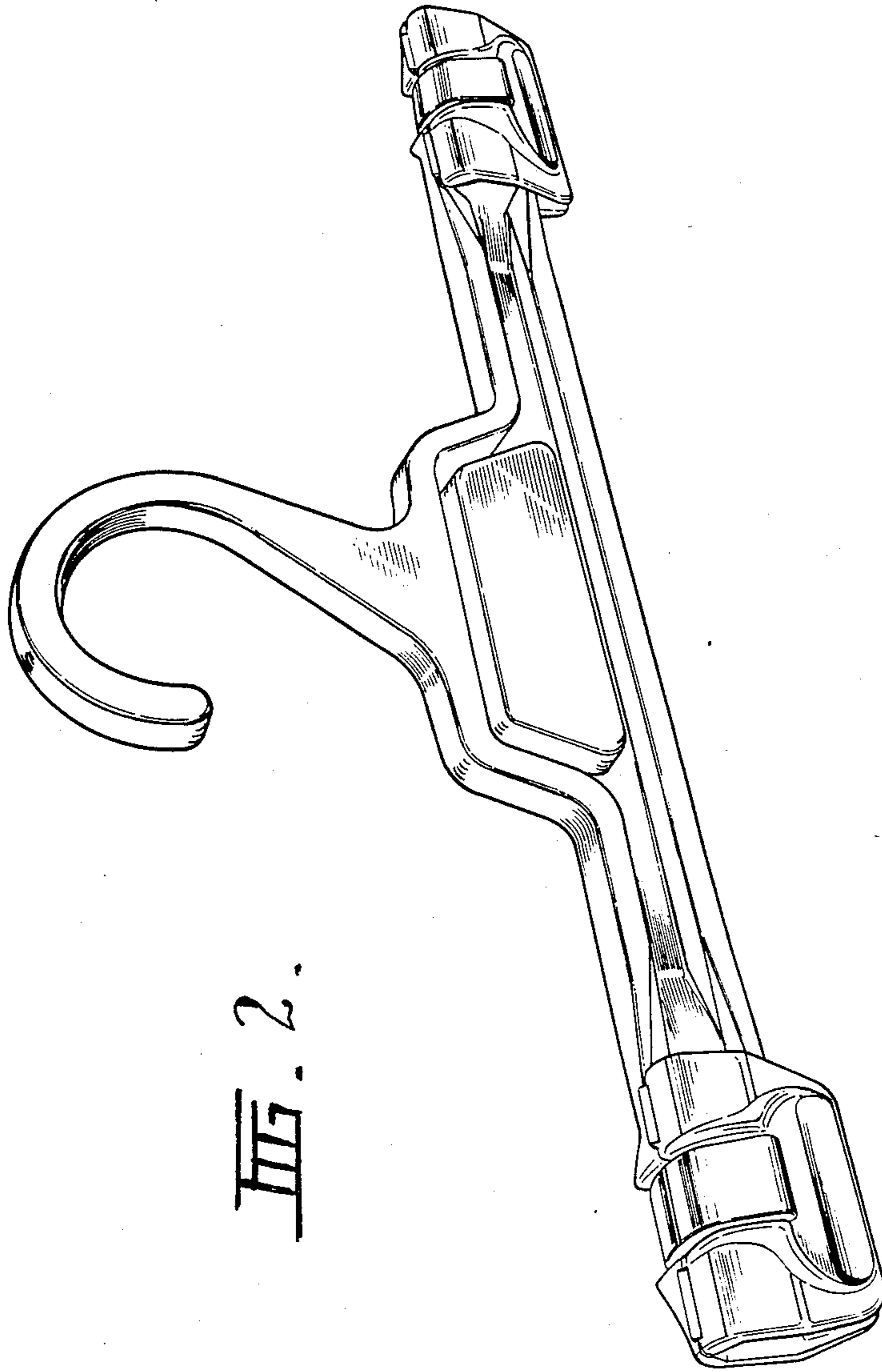

FIG. 2.

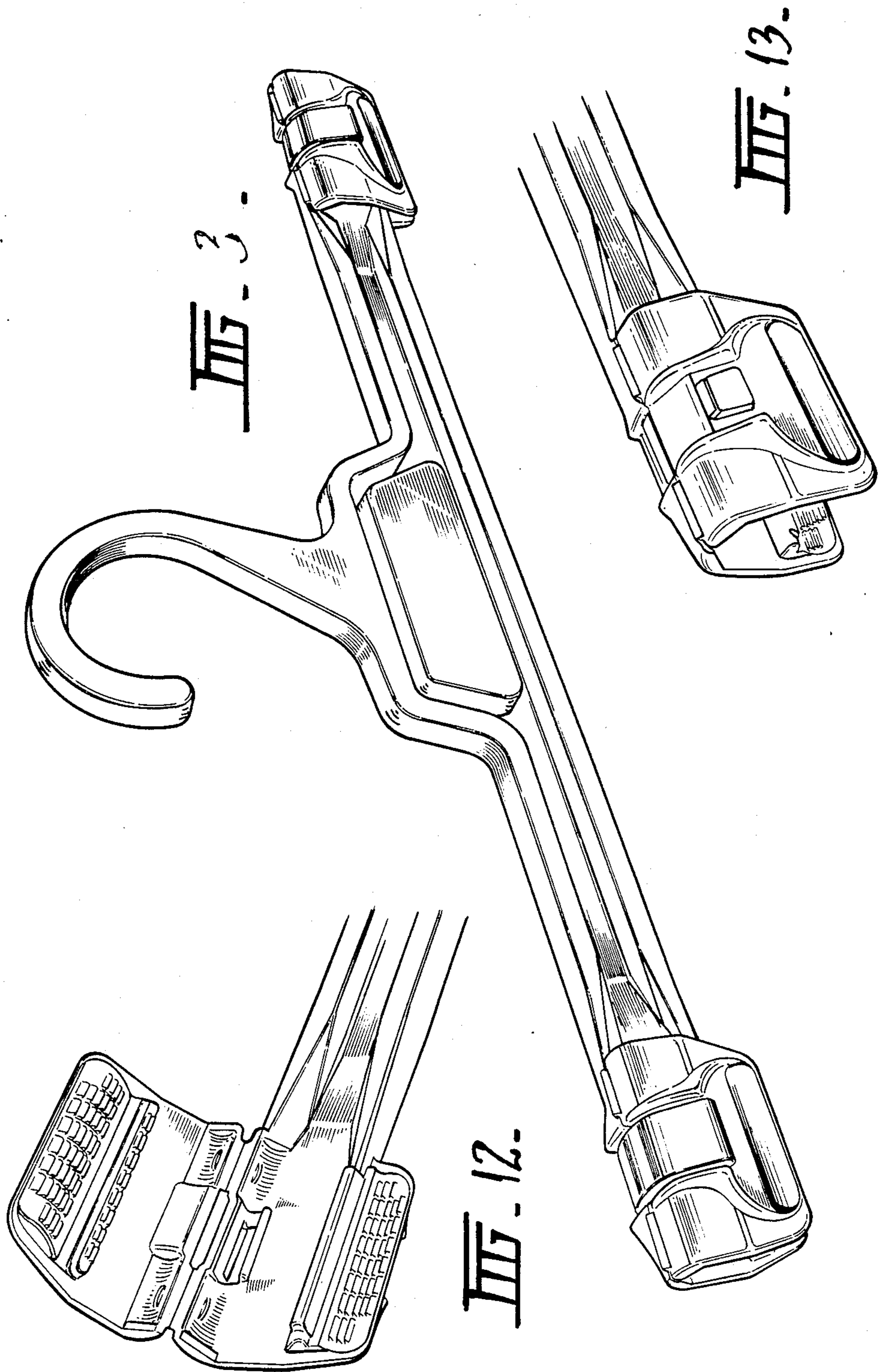
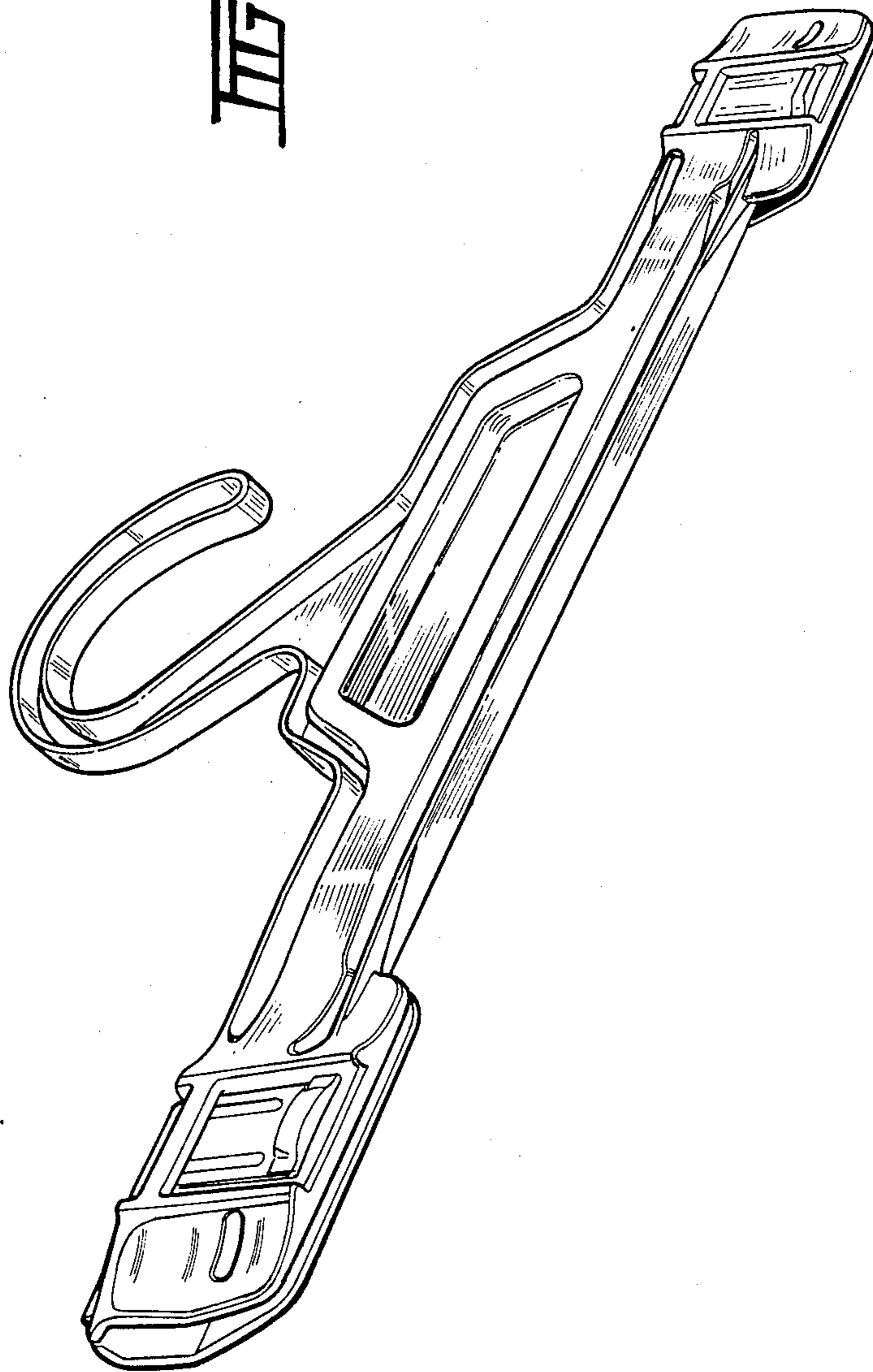
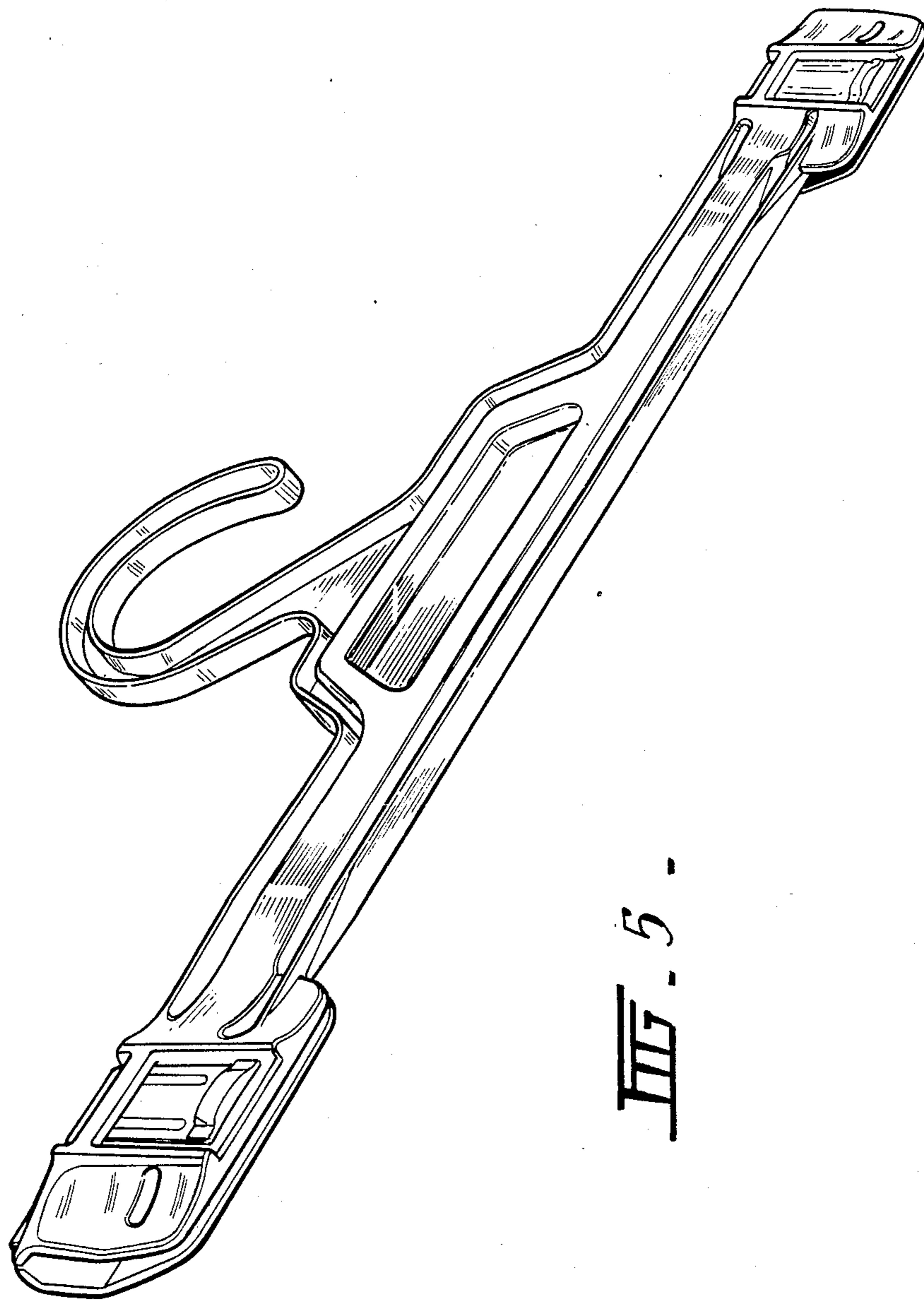

FIG. 4.





III - 5 -

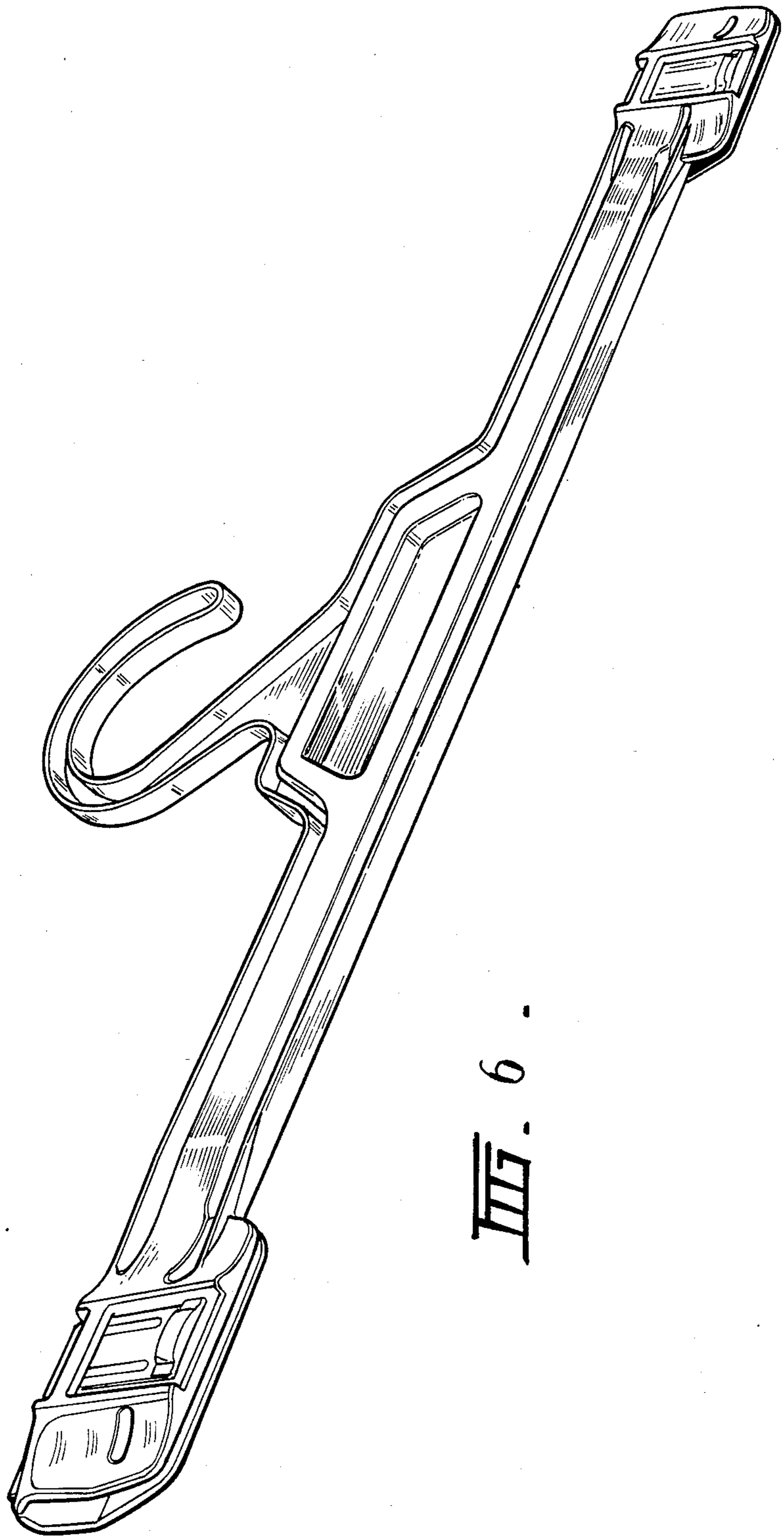

FIG. 6.

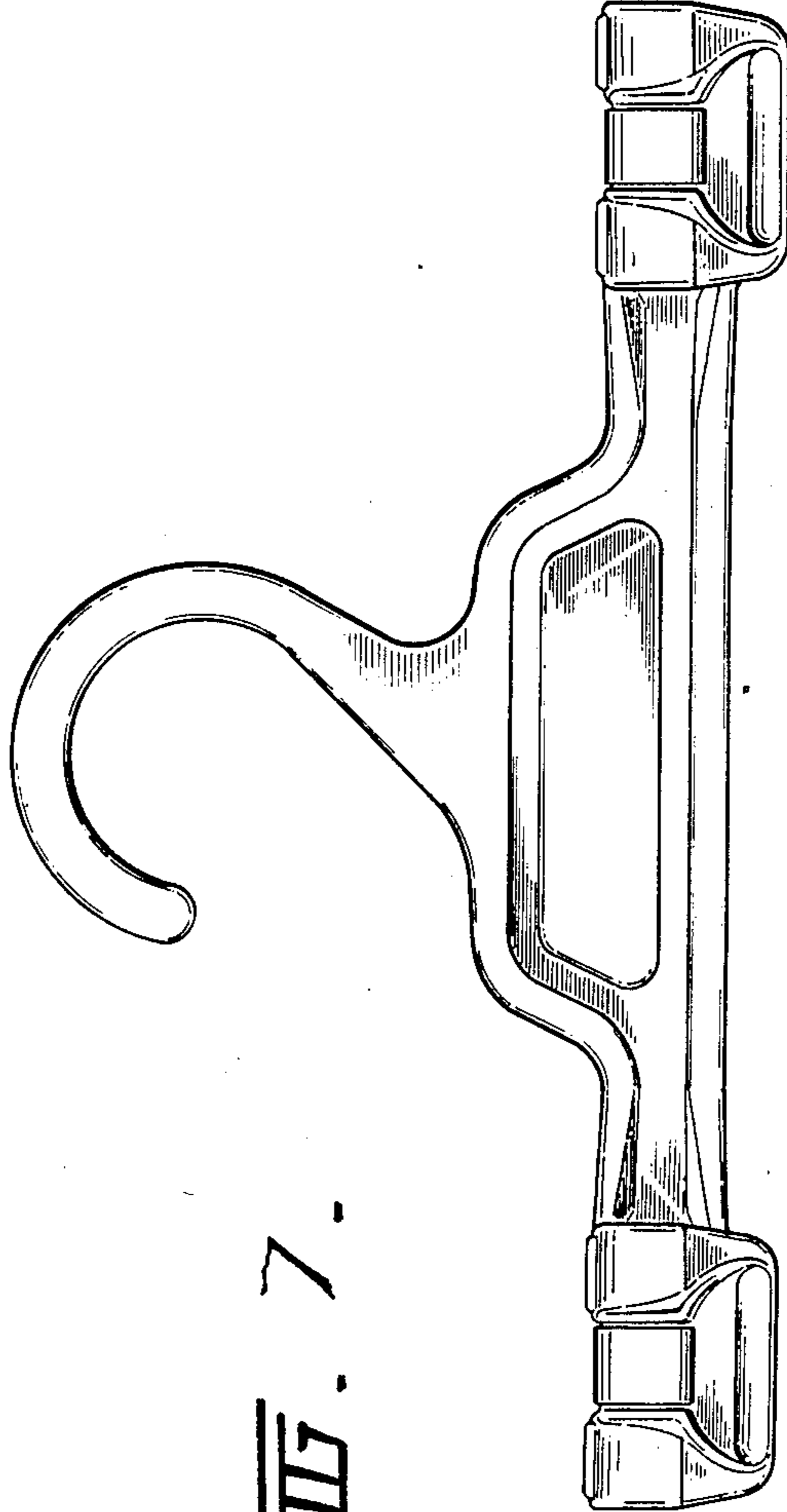

FIG. 7.

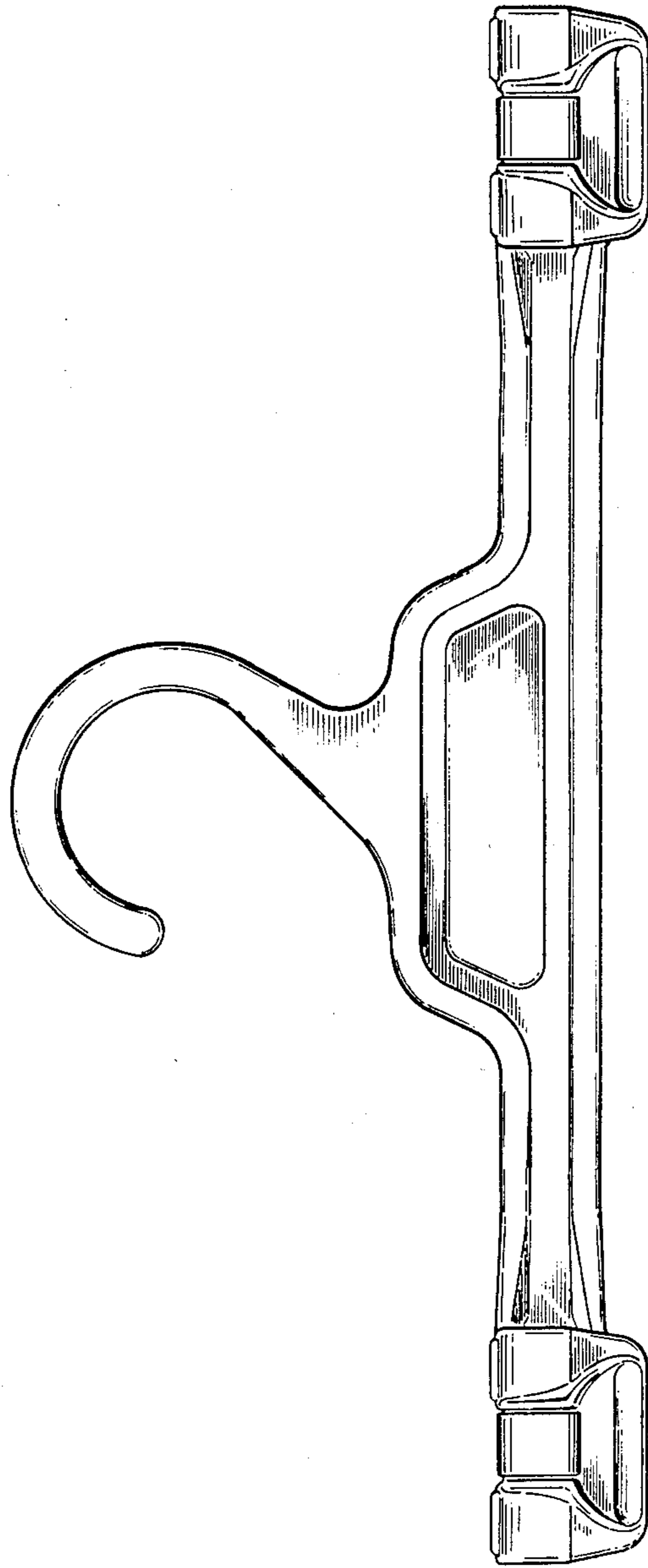
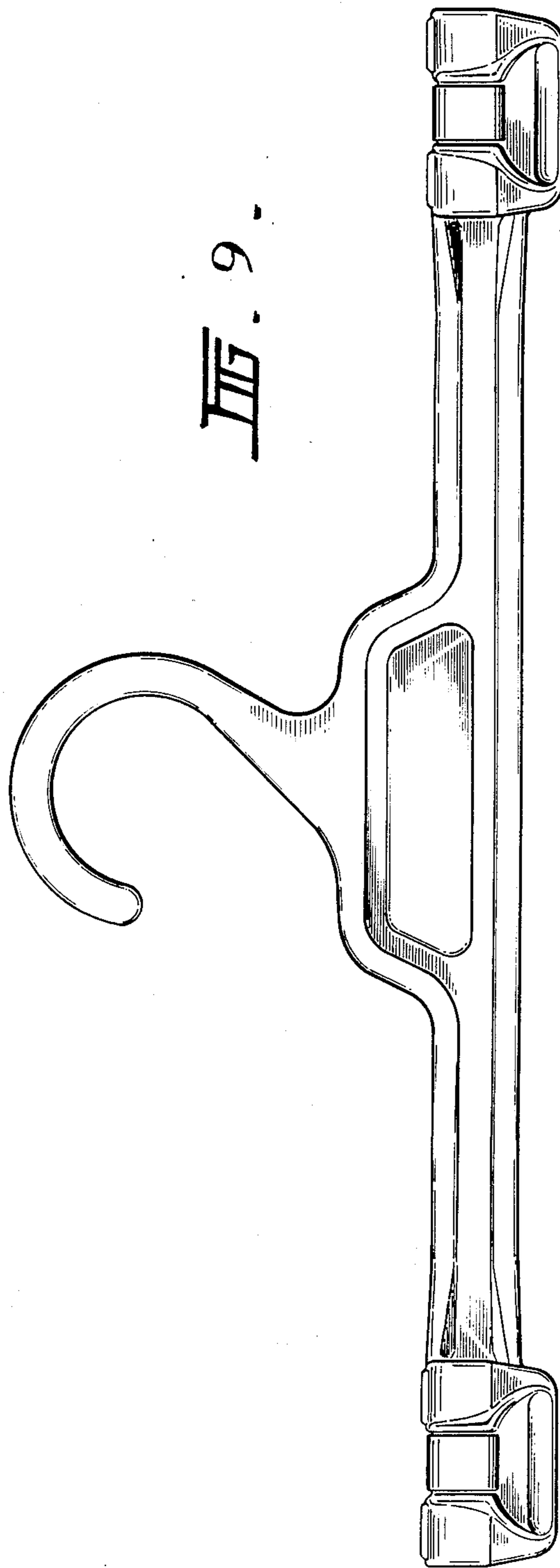

FIG. 8.



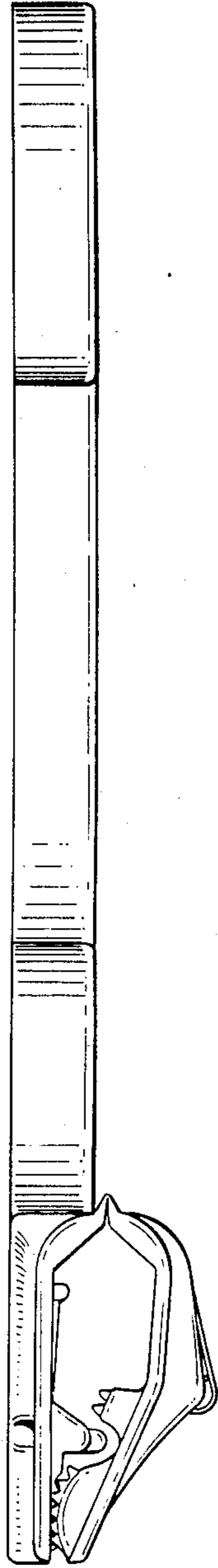

FIG. 10 .

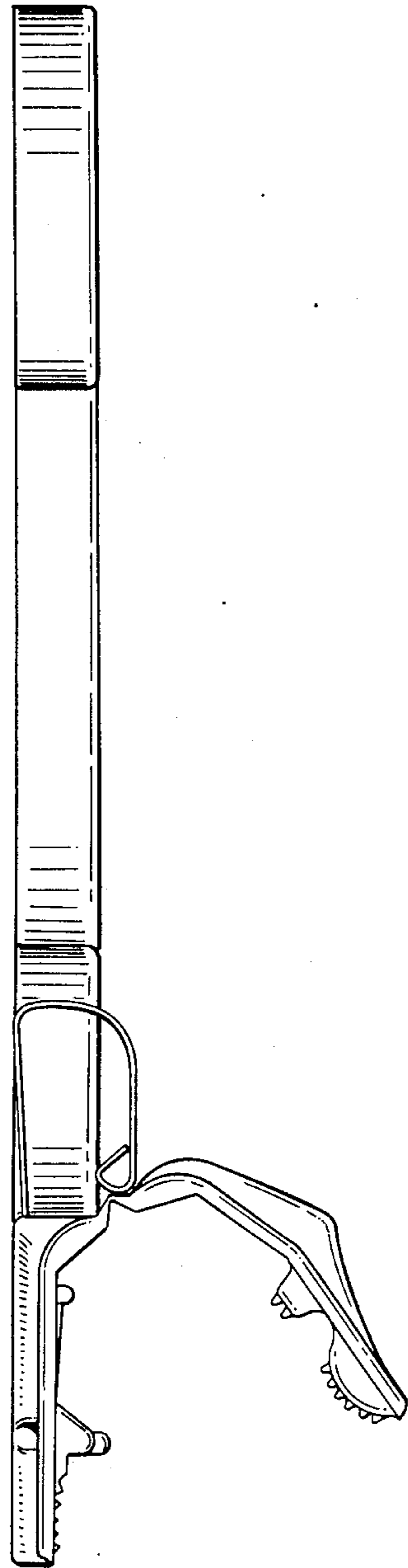

FIG. 11 .