

# United States Patent [19]

Mednick

[11] Patent Number: **Des. 299,006**

[45] Date of Patent: **\*\* Dec. 20, 1988**

- [54] **CLIP**
- [75] **Inventor:** David Mednick, Philadelphia, Pa.
- [73] **Assignee:** Shark Products, Inc., Upland, Pa.
- [\*\*] **Term:** 14 Years
- [21] **Appl. No.:** 932,892
- [22] **Filed:** Nov. 10, 1986
- [52] **U.S. Cl.** ..... D8/388; D8/395; D21/157
- [58] **Field of Search** ..... D8/1, 394-396, D8/388, 391; D21/157; D11/157; D6/417; 248/508; 24/509, 510

D. 270,133	8/1983	Craig	.....	D8/388
D. 275,555	9/1984	Giggey	.....	D8/388
2,840,092	6/1958	Hill	.....	248/508
2,939,468	6/1960	Boyce	.....	248/508

*Primary Examiner*—B. J. Bullock  
*Attorney, Agent, or Firm*—Louis Weinstein

### [57] CLAIM

The ornamental design for a clip, as shown.

### DESCRIPTION

- FIG. 1 is a front, right perspective view of a clip showing my new design;
- FIG. 2 is a rear, left perspective view thereof;
- FIG. 3 is a top plan view thereof.
- FIG. 4 is a bottom plan view thereof.
- FIG. 5 is a rear elevational view thereof.
- FIG. 6 is a front elevational view thereof.
- FIG. 7 is a right side elevational view thereof;
- FIG. 8 is a left side elevational view thereof.

- [56] **References Cited**
- U.S. PATENT DOCUMENTS**
- D. 219,229 11/1970 Noble ..... D21/157
- D. 262,514 1/1982 Gilbert ..... D8/394

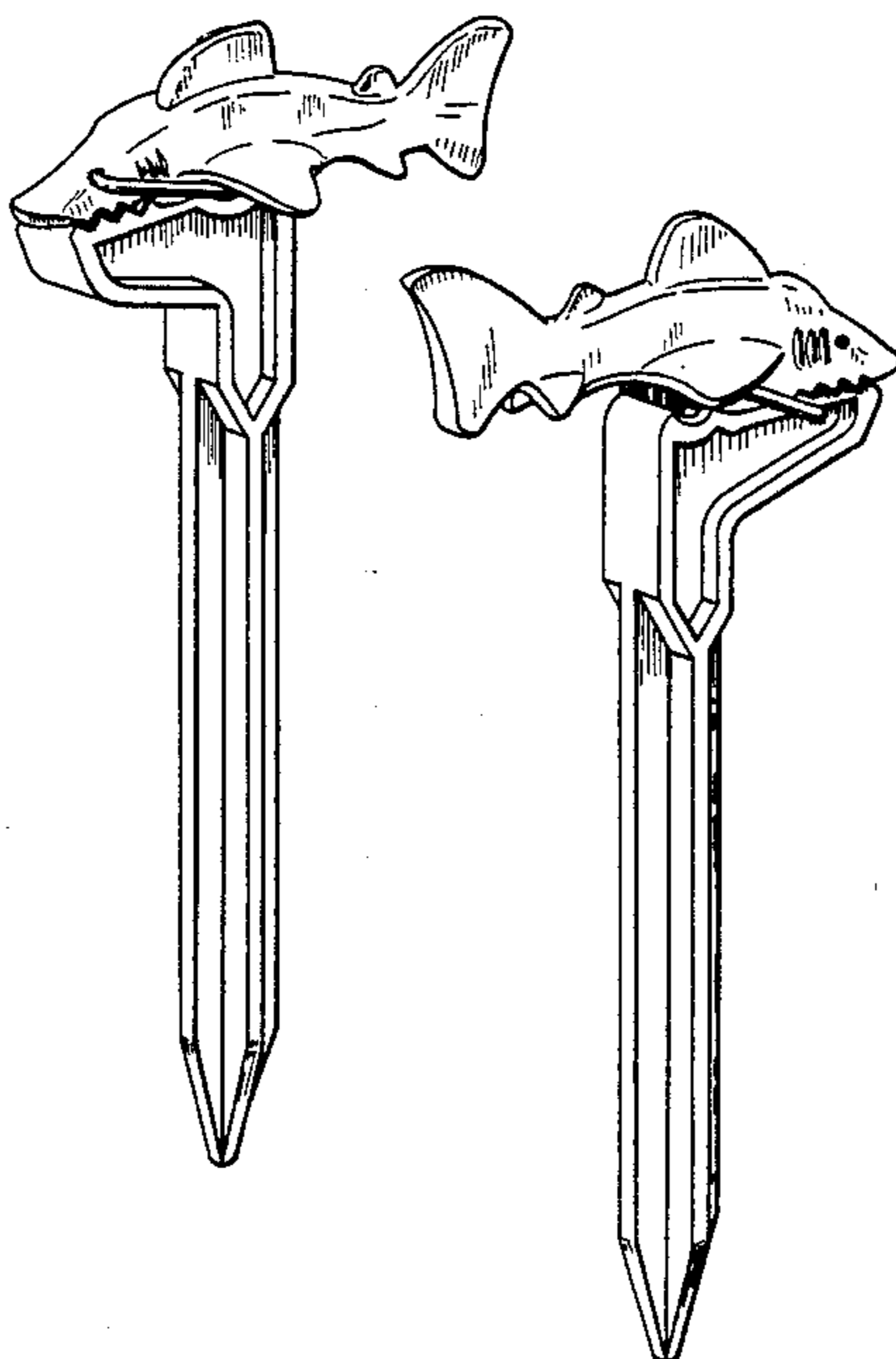

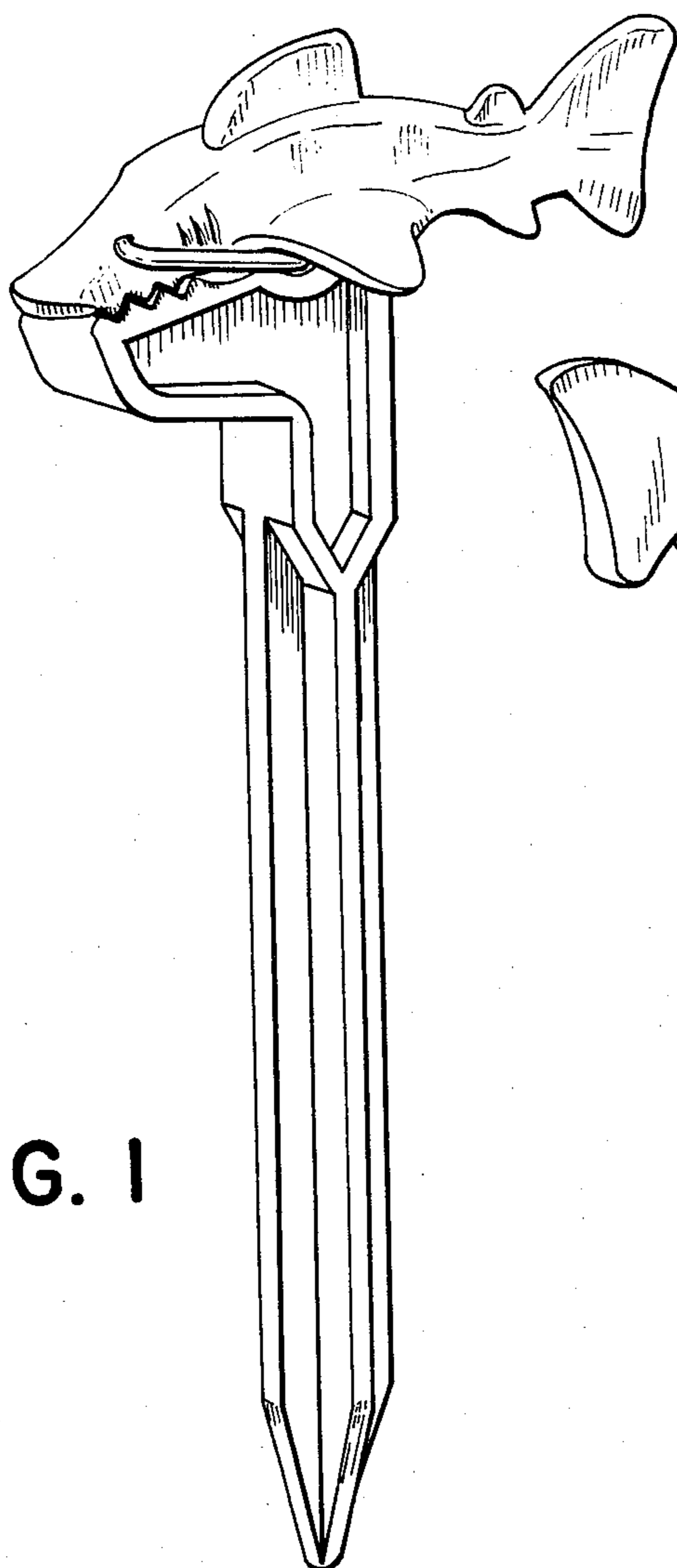

FIG. 1

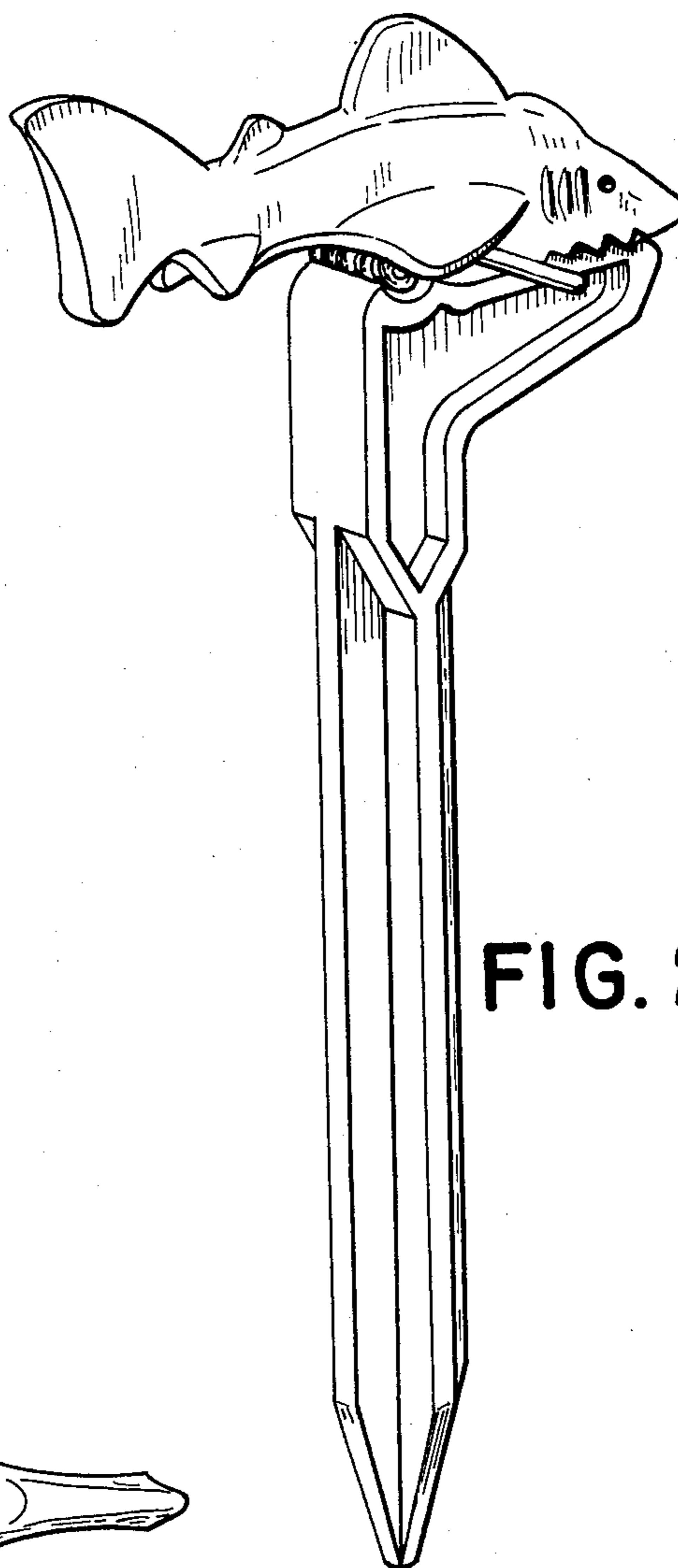

FIG. 2

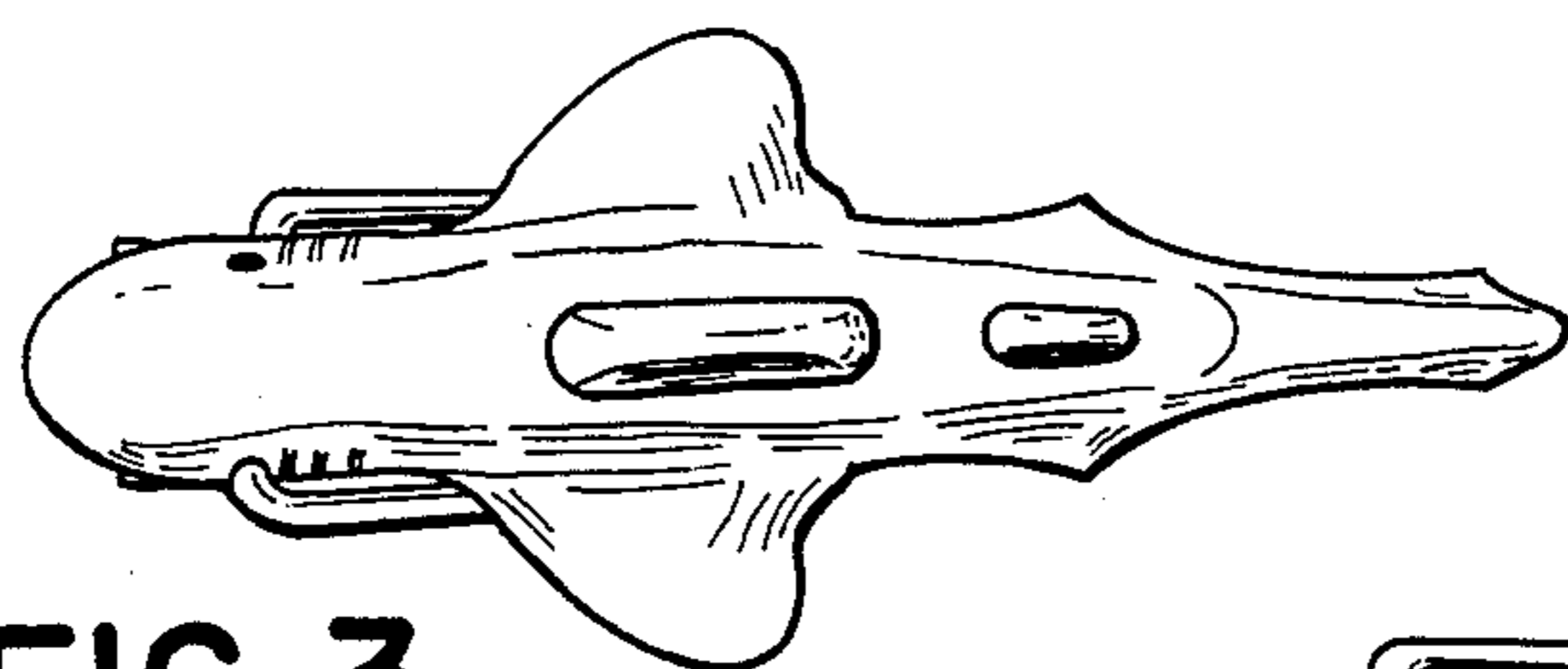

FIG. 3

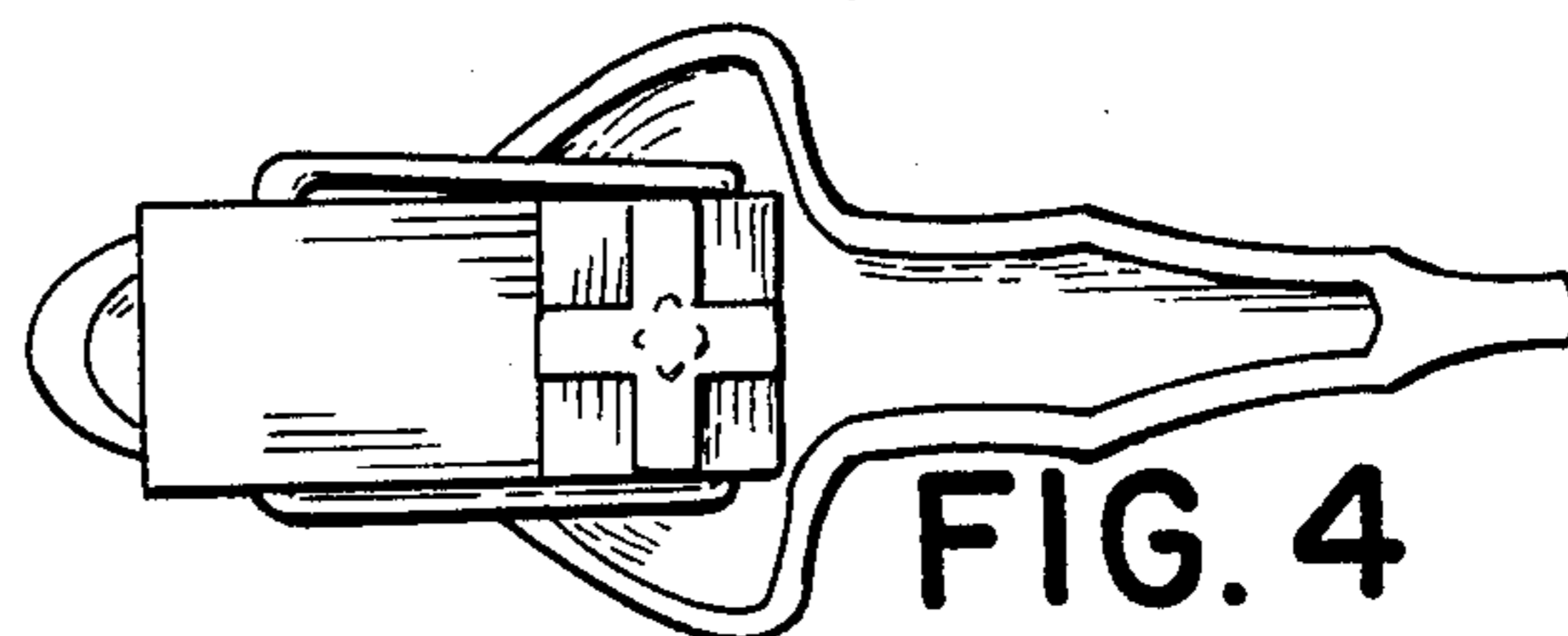

FIG. 4

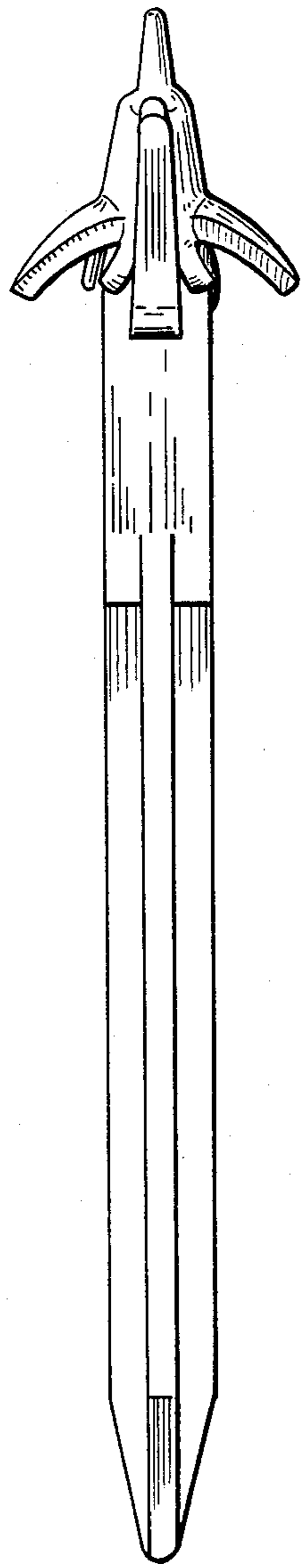

FIG. 5

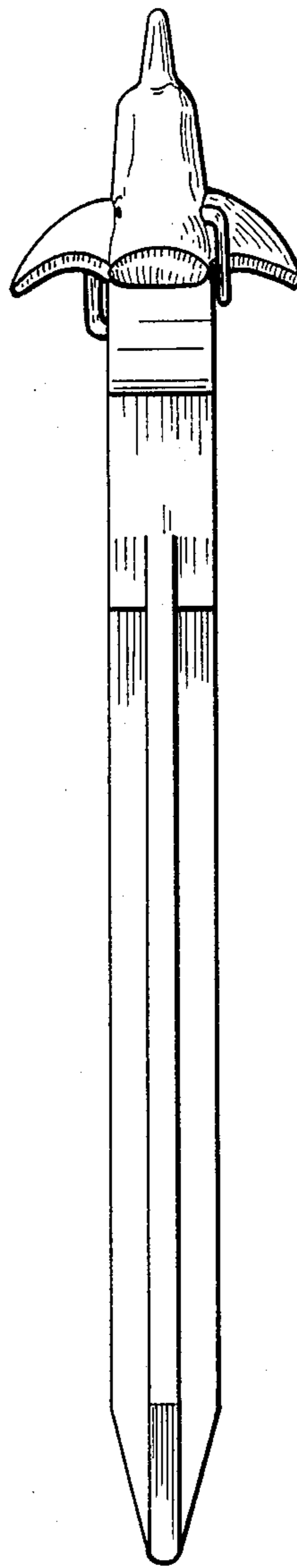

FIG. 6

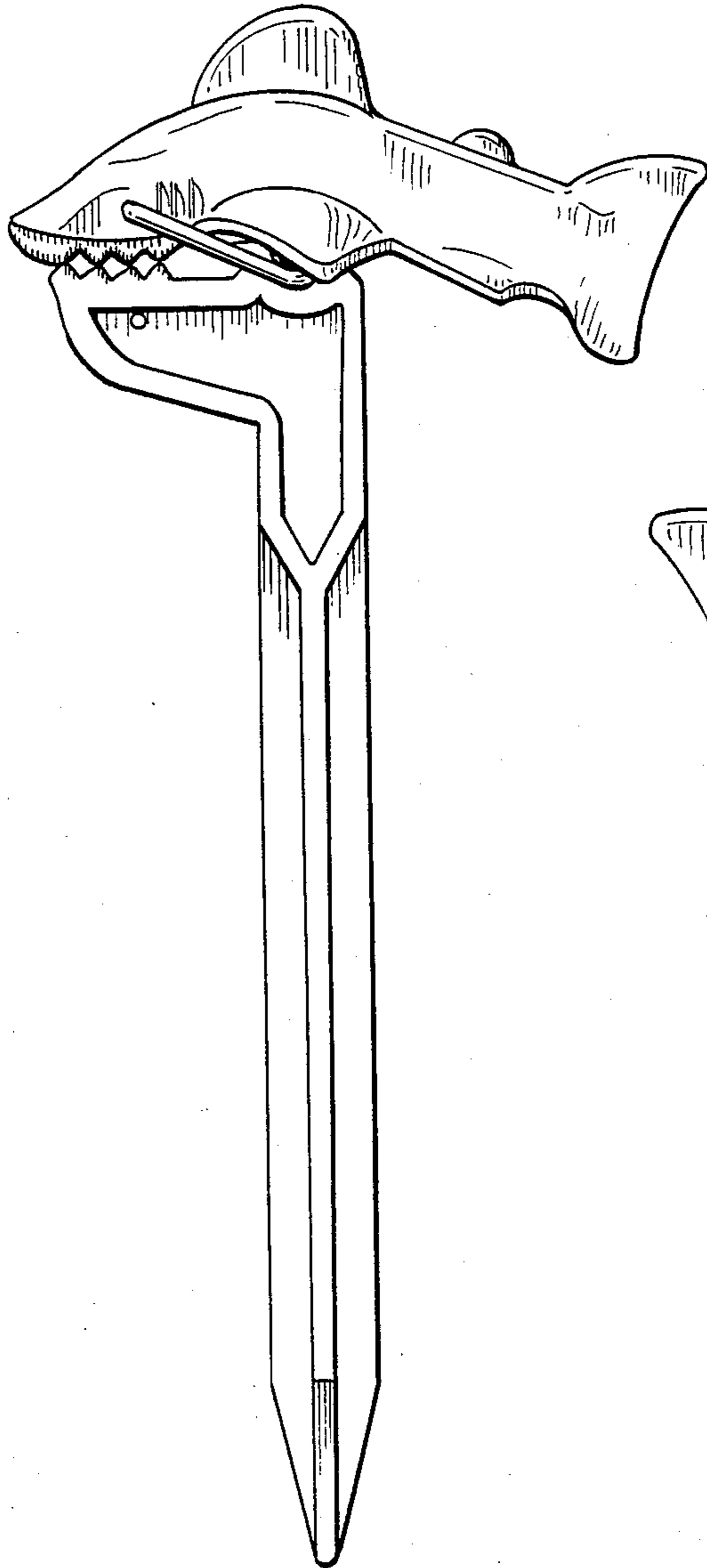

FIG. 7

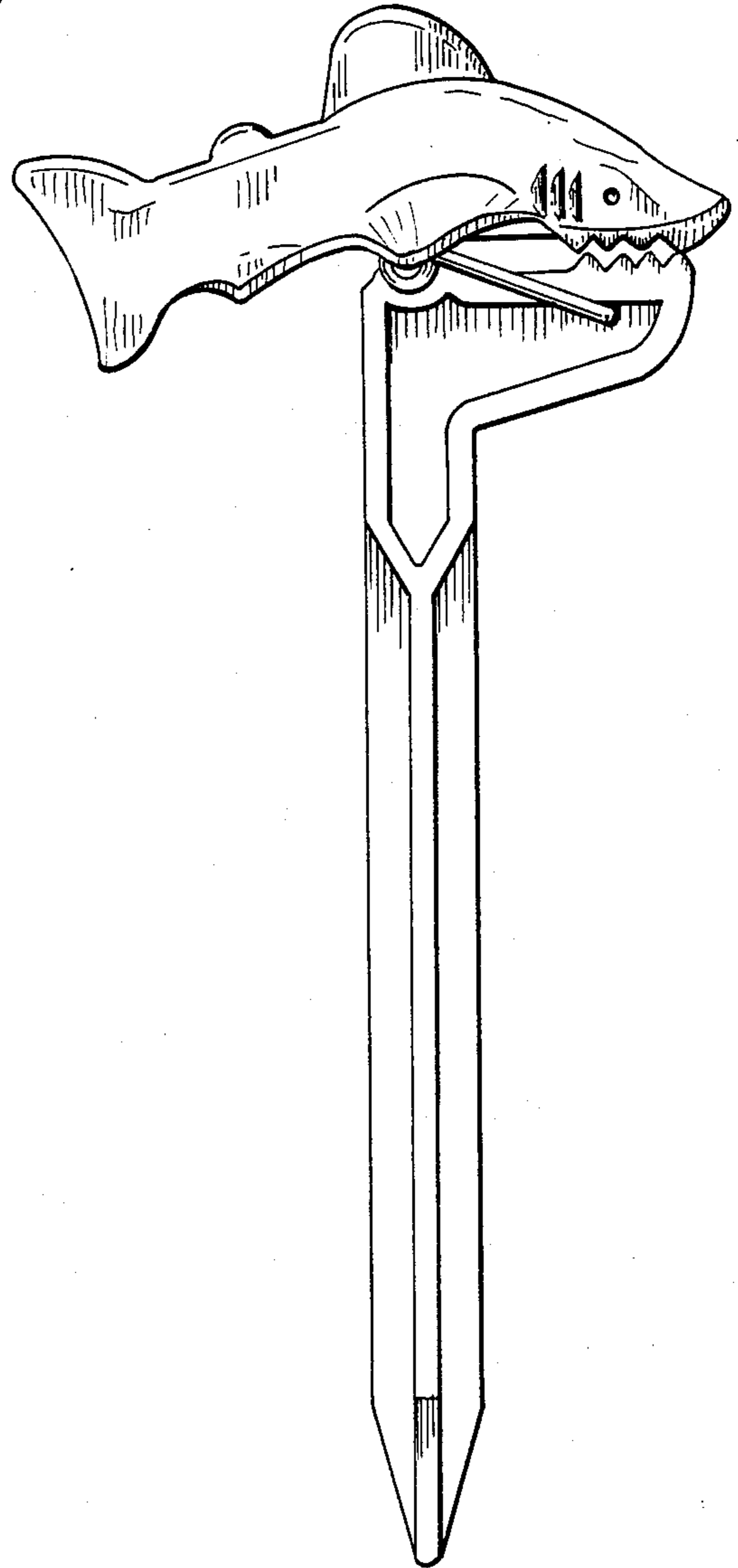

FIG. 8