

[54] **MOTOR VEHICLE CLEANING AND RESTORATION BUILDING**

[76] **Inventor: Judson L. Smith, 5432 Lighthouse La., Tempe, Ariz. 85283**

[**] **Term: 14 Years**

[21] **Appl. No.: 743,631**

[22] **Filed: Jun. 11, 1985**

[52] **U.S. Cl. D25/31; D25/25**

[58] **Field of Search D25/1, 31, 32, 25**

[56] **References Cited**

U.S. PATENT DOCUMENTS

D. 157,449 2/1950 Tesch D25/32 X

D. 248,570 7/1978 Smith et al. D25/31

*Primary Examiner—A. Hugo Word
Attorney, Agent, or Firm—Woodard, Emhardt,
Naughton Moriarty & McNett*

[57] **CLAIM**

The ornamental design for a motor vehicle cleaning and restoration building, as shown and described.

DESCRIPTION

FIG. 1 is a front elevational view of the motor vehicle cleaning and restoration building showing my new design;

FIG. 2 is a rear elevational view thereof;

FIG. 3 is a side elevational view thereof as seen from the right-side in FIG. 2;

FIG. 4 is a top plan view thereof.

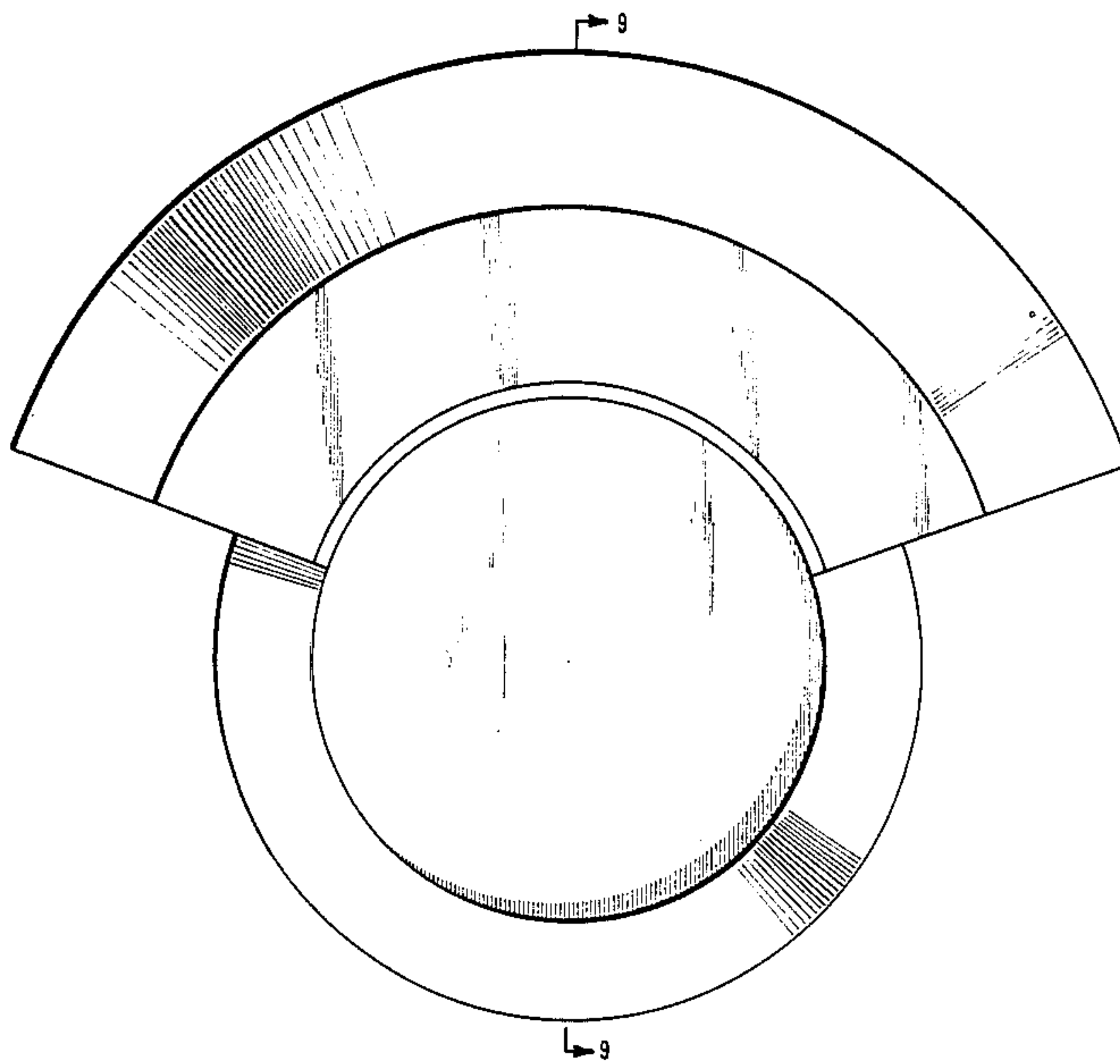
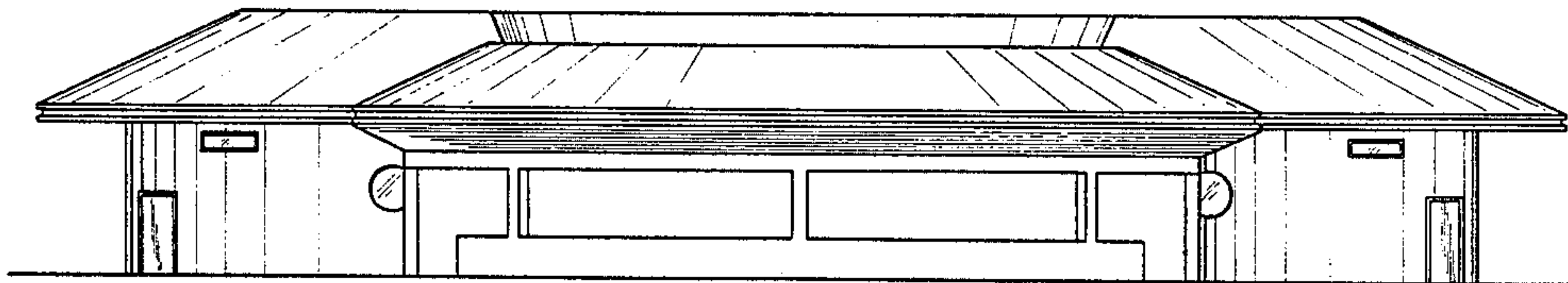

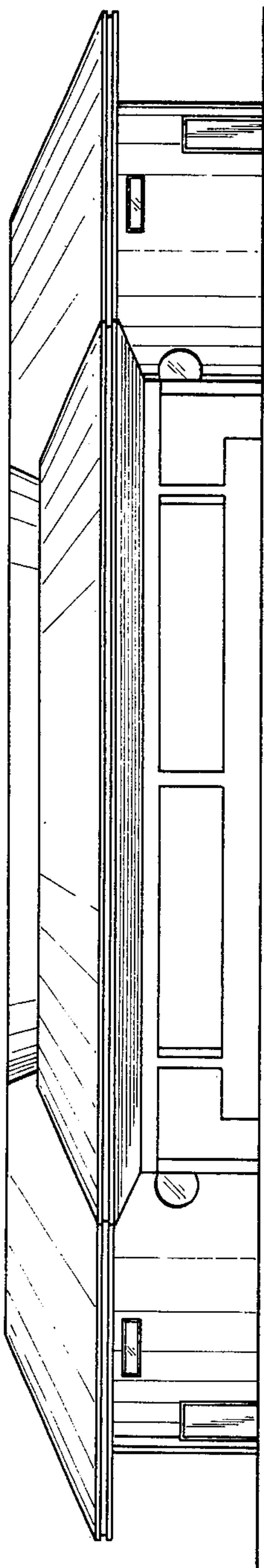

Fig. 1

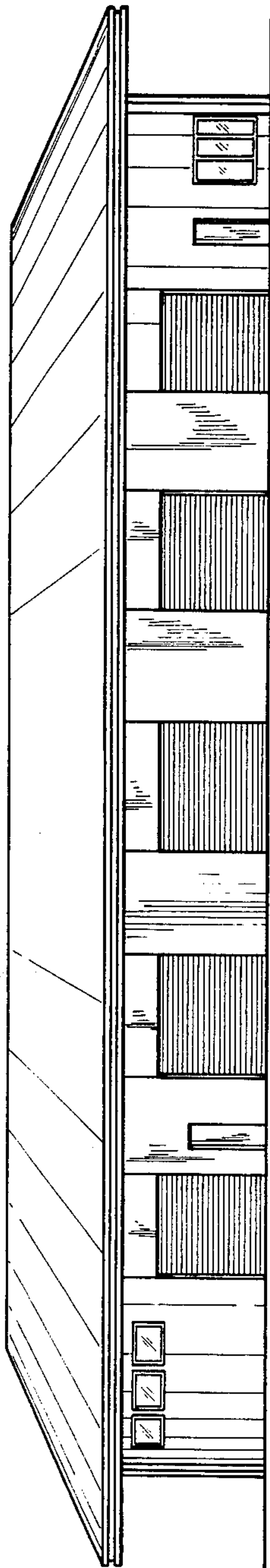

Fig. 2

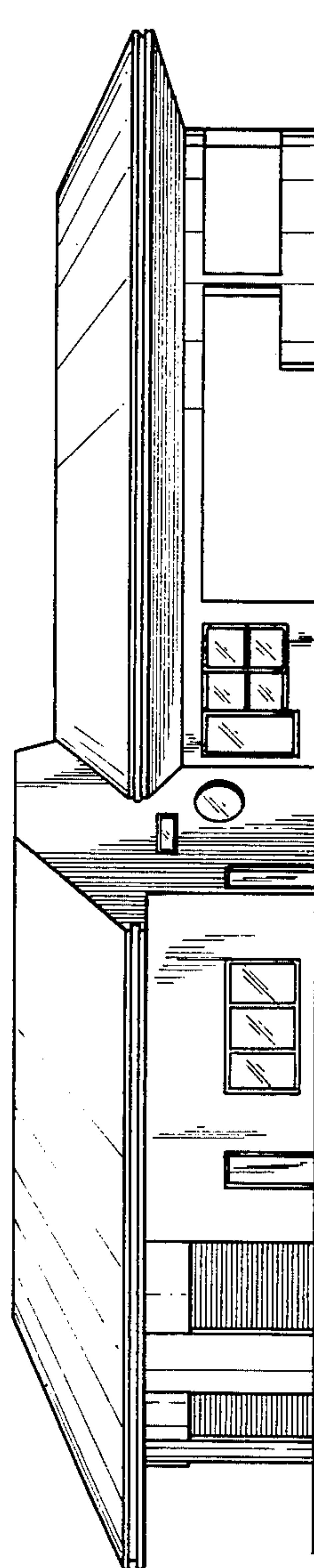
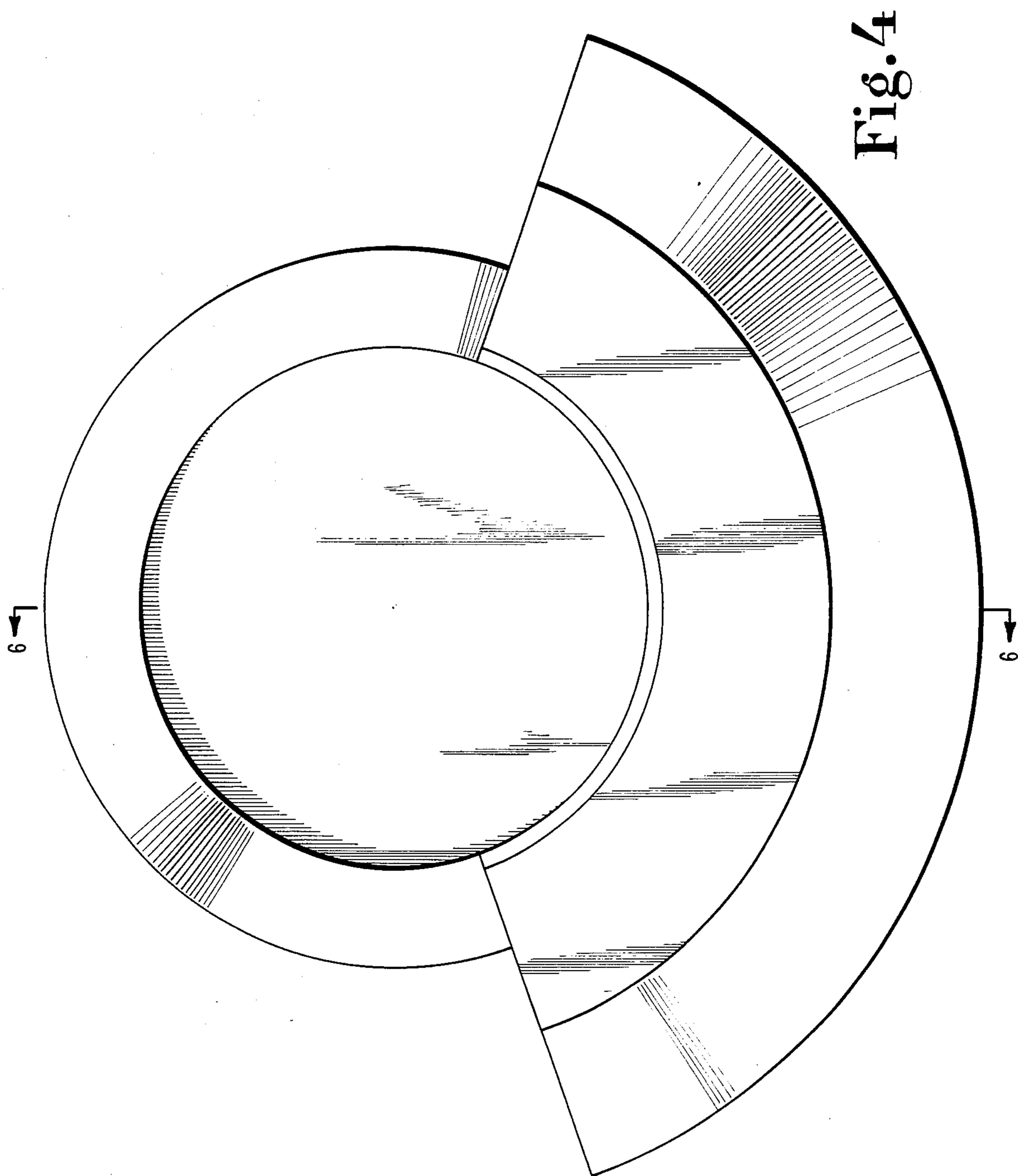

Fig. 3



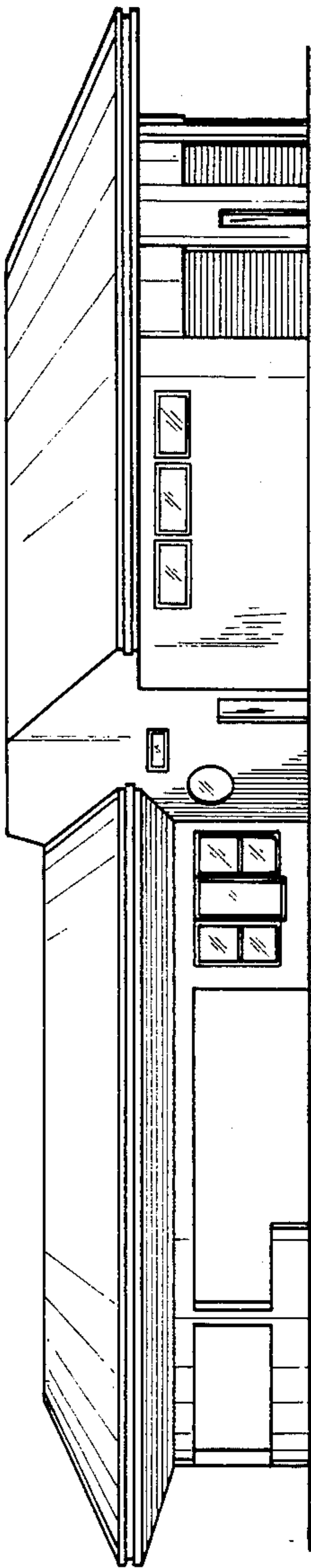

Fig. 5

UNITED STATES PATENT AND TRADEMARK OFFICE
CERTIFICATE OF CORRECTION

PATENT NO. : Des. 298,971
DATED : December 13, 1988
INVENTOR(S) : Judson L. Smith

It is certified that error appears in the above-identified patent and that said Letters Patent is hereby corrected as shown below:

Add the description of Fig. 5 as follows:

--FIG. 5 is a side elevational view thereof as seen from the left side in FIG. 2.--

**Signed and Sealed this
Ninth Day of May, 1989**

Attest:

DONALD J. QUIGG

Attesting Officer

Commissioner of Patents and Trademarks