

[54] DESK ORGANIZER

[76] Inventor: Raymond P. Roberts, P.O. Box 1117, Tulsa, Okla. 74101

[\*\*] Term: 14 Years

[21] Appl. No.: 807,014

[22] Filed: Nov. 29, 1985

[52] U.S. Cl. .... D19/78; D10/2

[58] Field of Search ..... D19/757, 86; D10/175; 206/214, 51.3, 37.4, 525, 526; 220/20; 221/92

[56] References Cited

U.S. PATENT DOCUMENTS

- D. 102,468 12/1936 McCoy ..... D19/78
- D. 113,519 2/1939 Meyer ..... D19/85
- D. 114,472 4/1939 Sandor ..... D19/92

- D. 151,959 12/1948 Bowers ..... D19/85
- D. 290,973 7/1987 O'Neil ..... D19/75

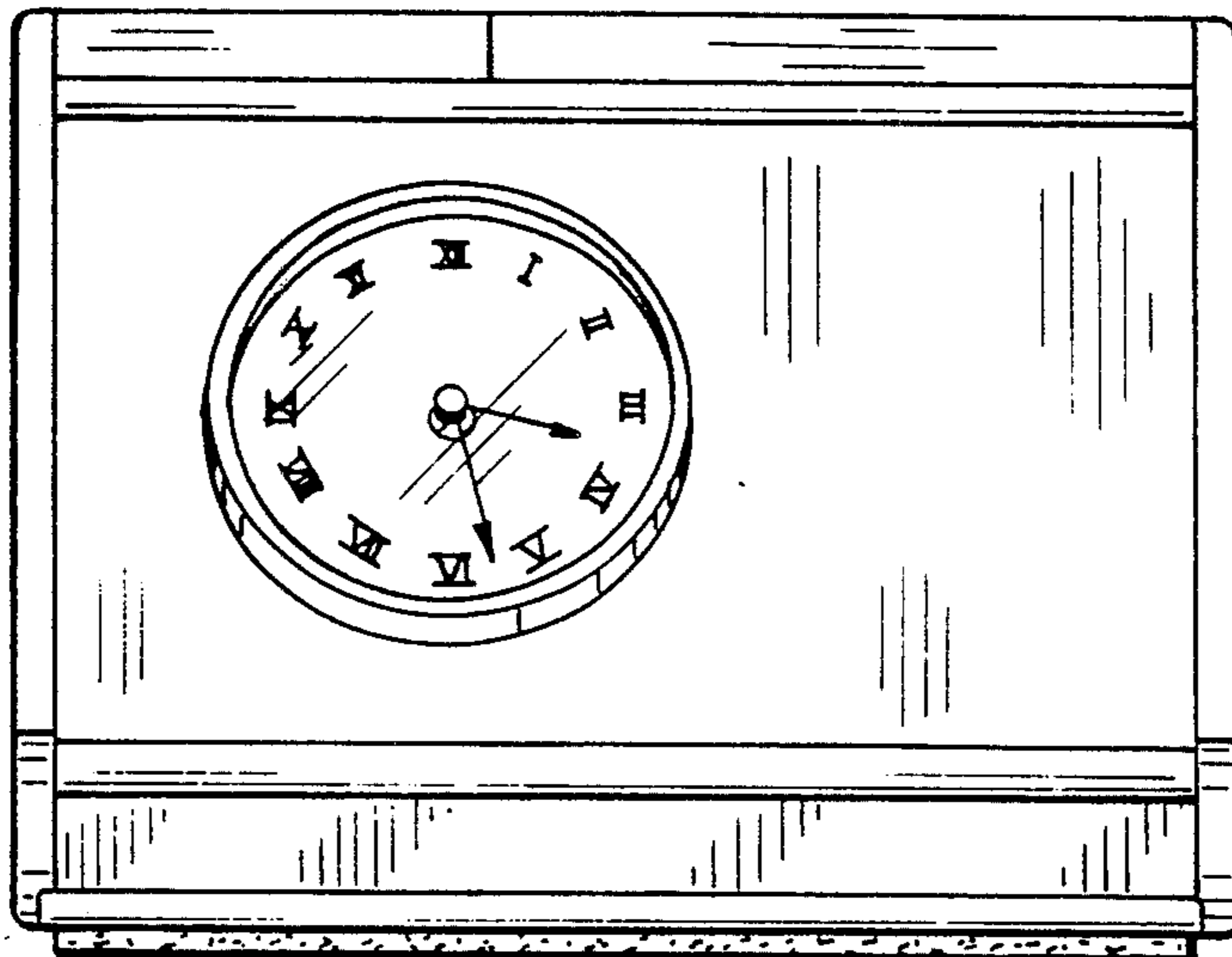
Primary Examiner—Charles A. Rademaker  
Attorney, Agent, or Firm—Head & Johnson

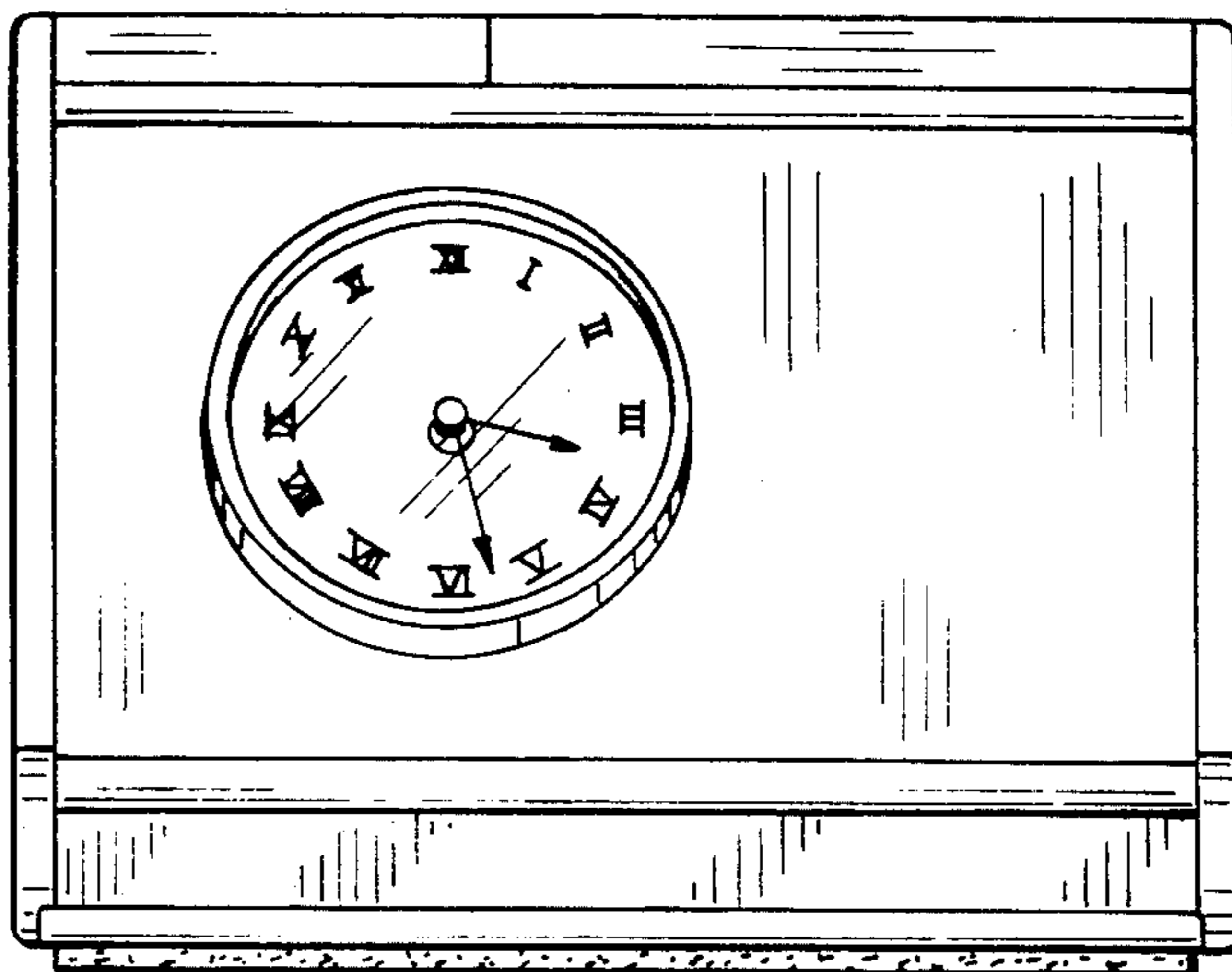
[57] CLAIM

The ornamental design for a desk organizer, substantially as shown and described.

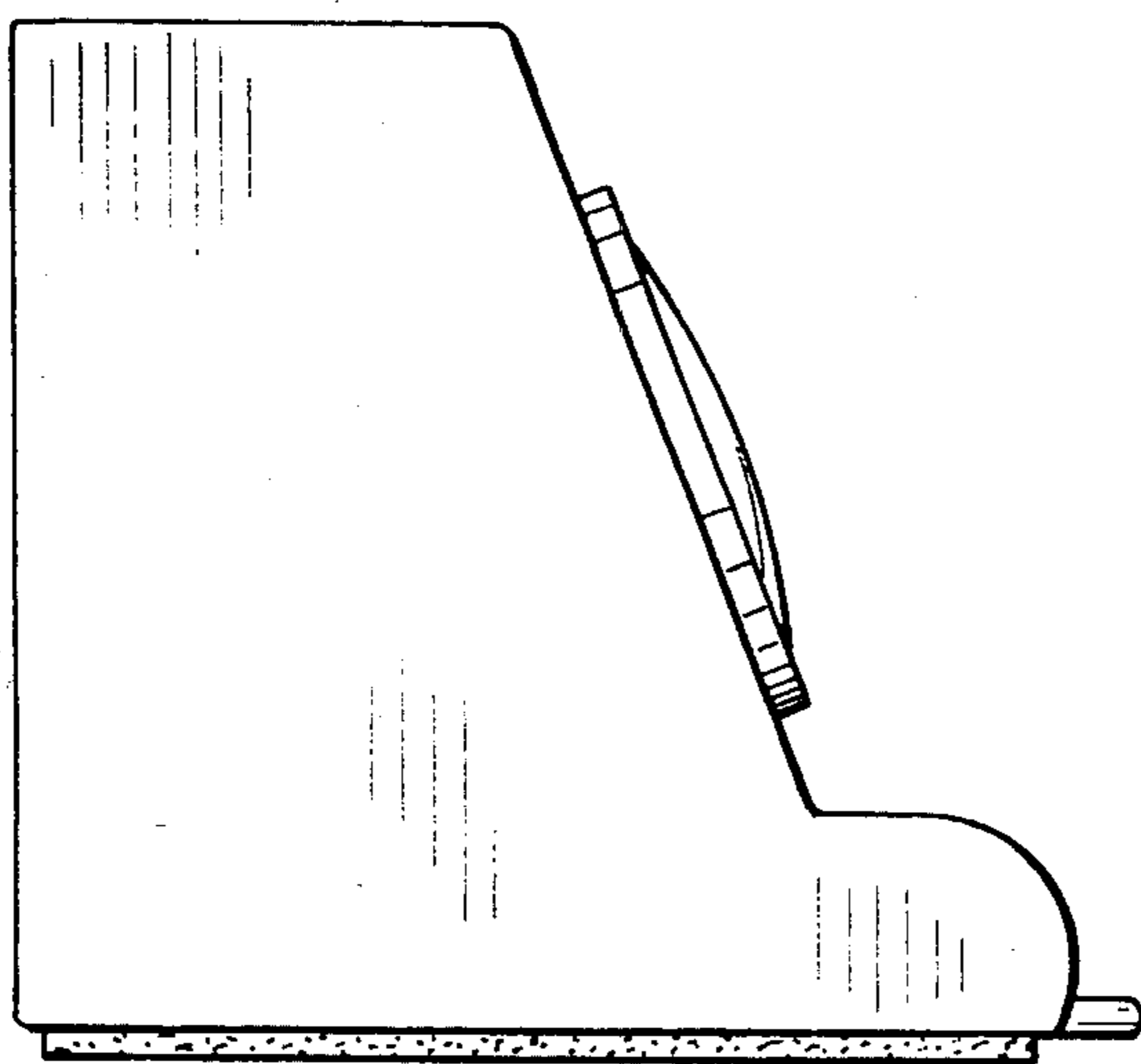
DESCRIPTION

FIG. 1 is a front elevational view of a desk organizer showing my new design;  
 FIG. 2 is a side elevational view thereof;  
 FIG. 3 is a rear elevational view thereof;  
 FIG. 4 is a top plan view thereof;  
 FIG. 5 is a bottom plan view thereof;  
 FIG. 6 is a perspective view thereof.

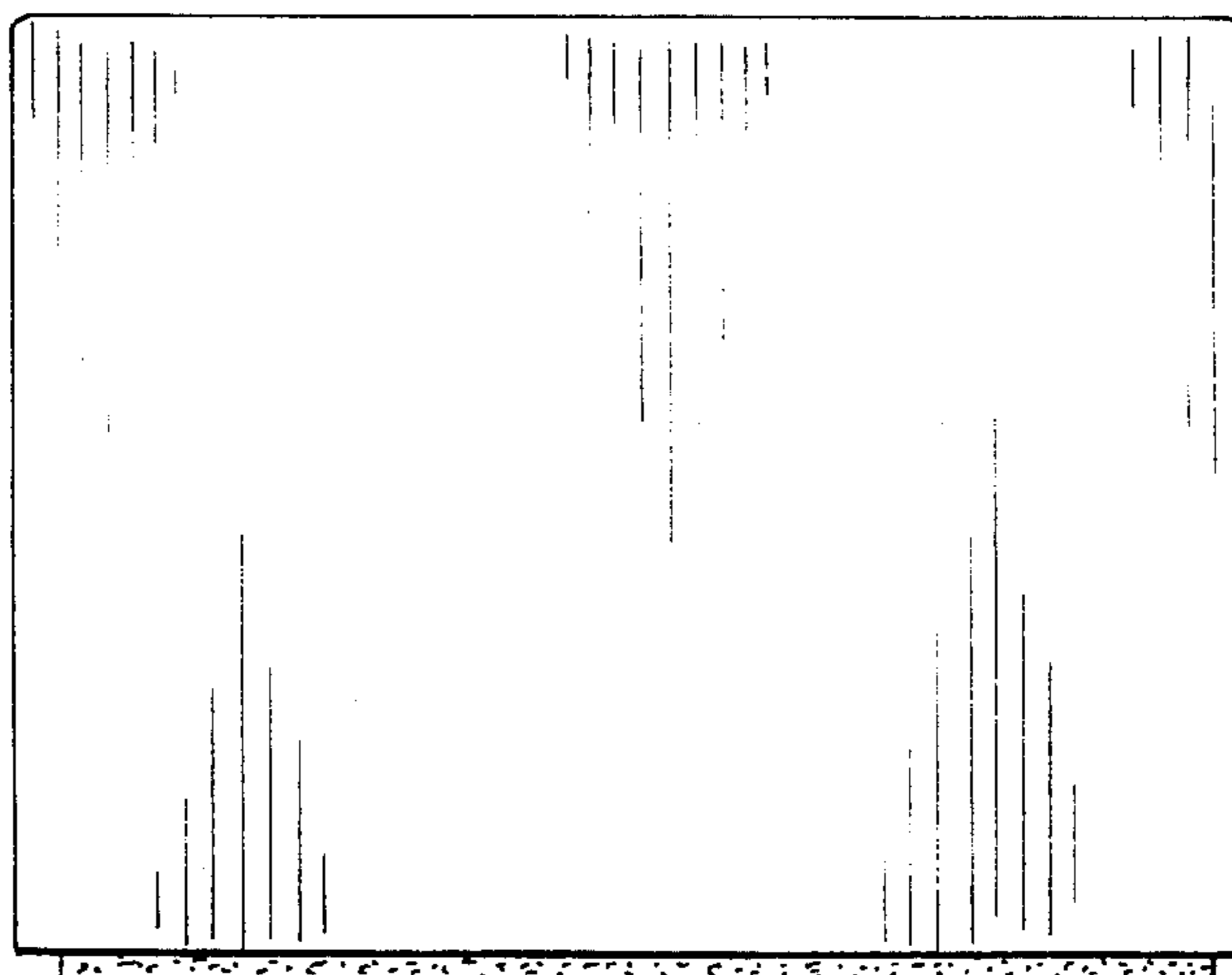




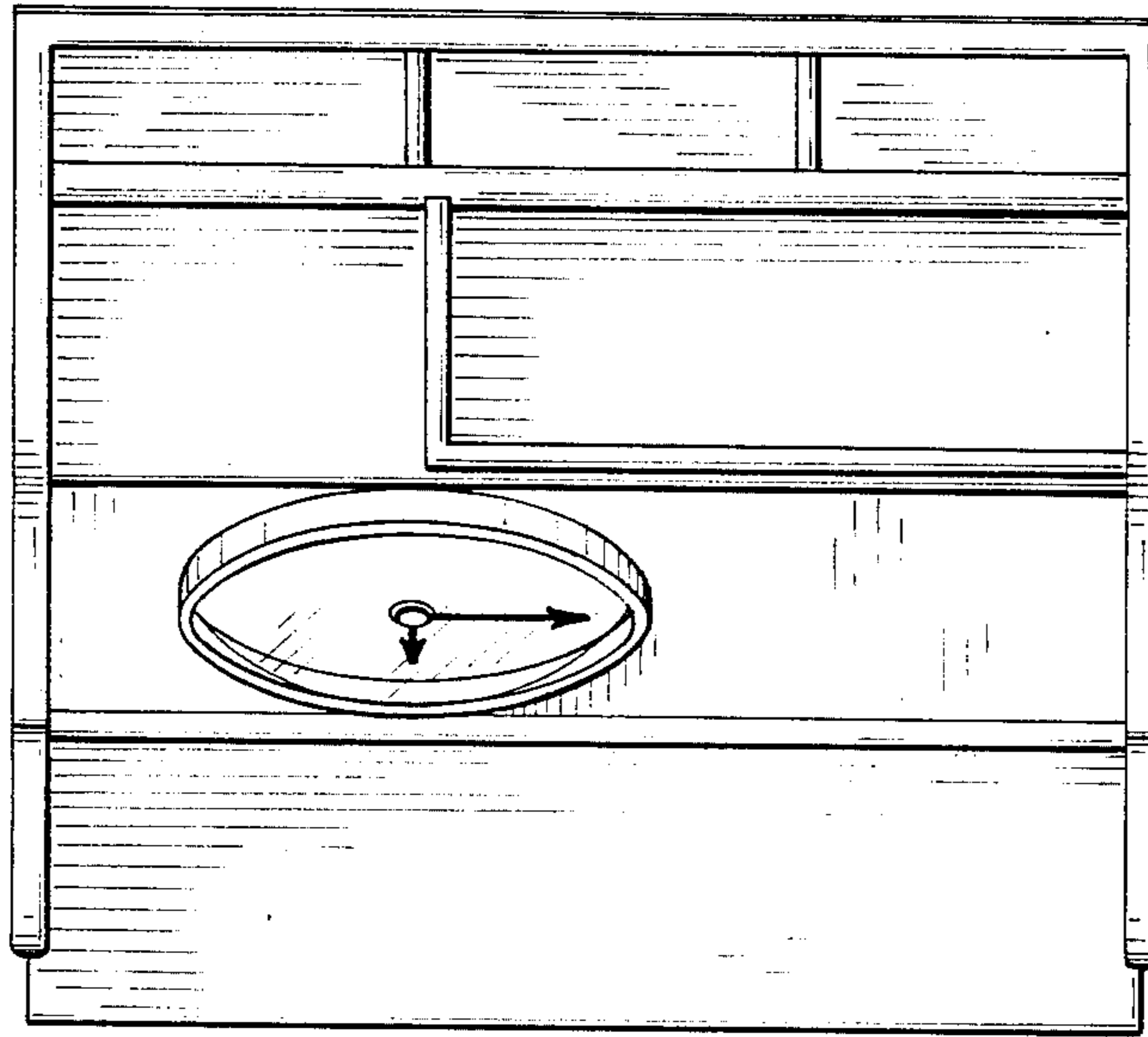
*Fig. 1*



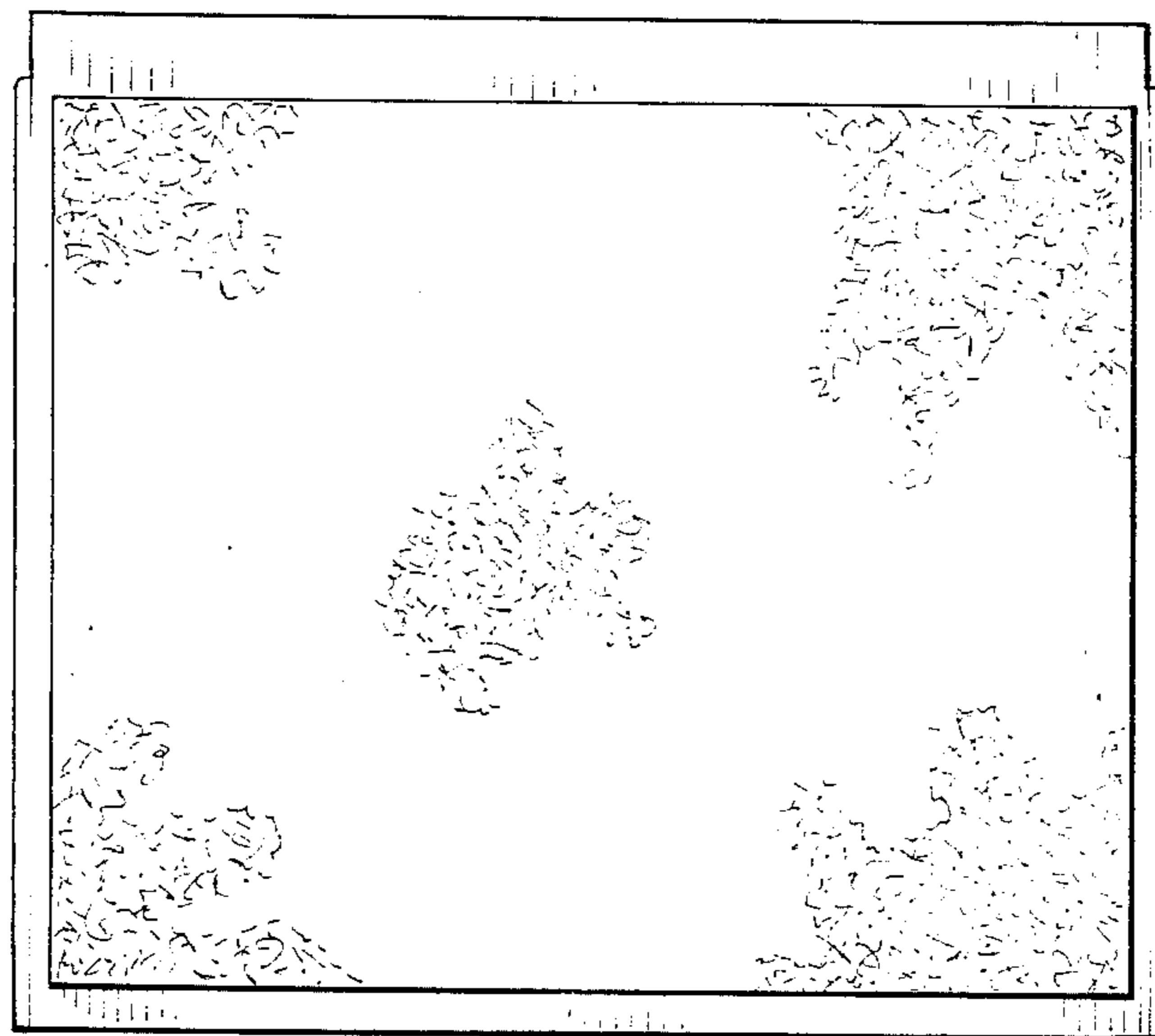
*Fig. 2*



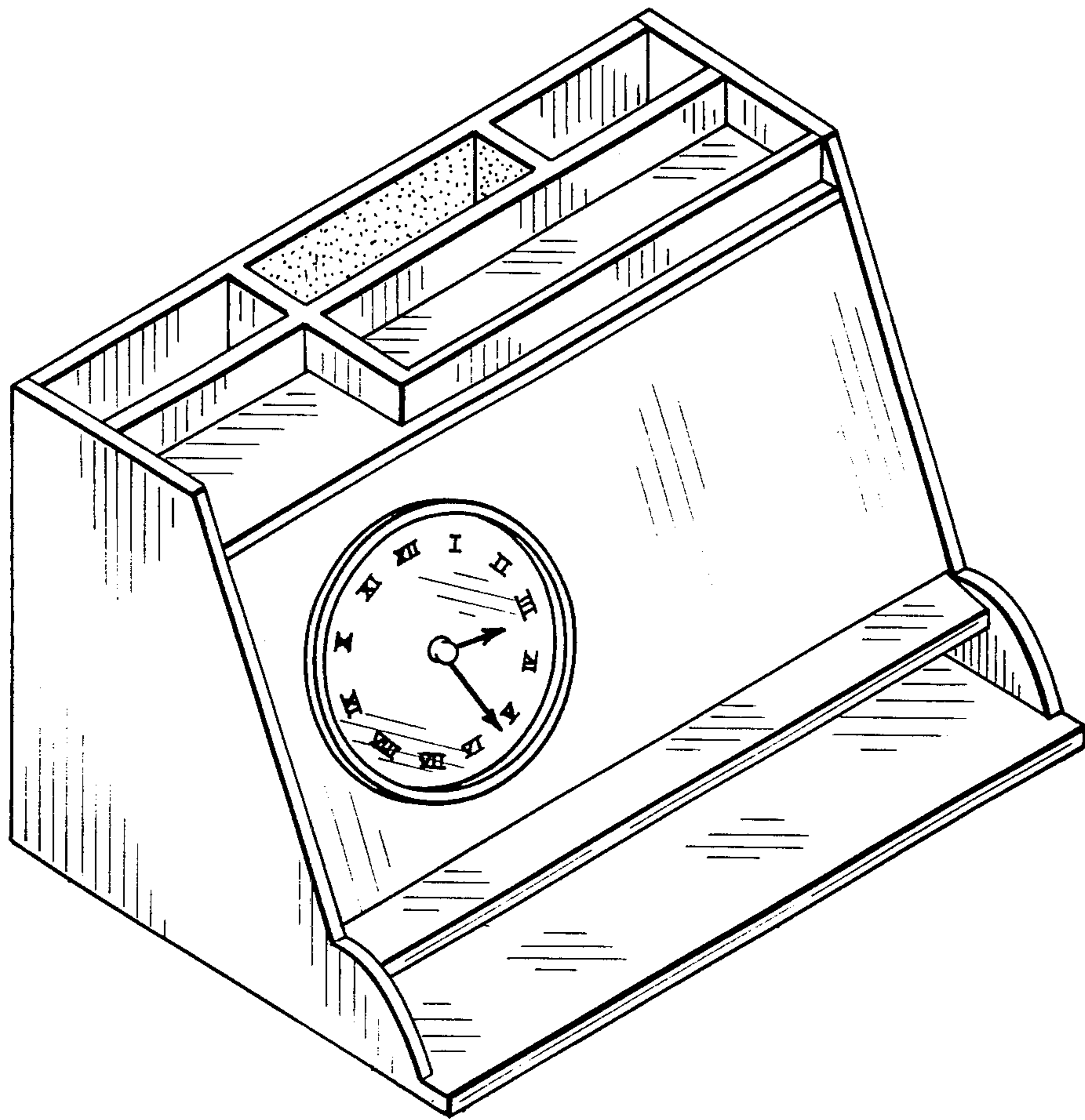
*Fig. 3*



*Fig. 4*



*Fig. 5*



*Fig. 6*