

[54] MINIATURE RECHARGEABLE POCKET LAMP

4,357,648 11/1982 Nelson ..... 362/184 X

[76] Inventor: Waldemar Witte, Steinbergerstrasse 2, 7157 Murrhardt, Fed. Rep. of Germany

Primary Examiner—Susan J. Lucas  
Attorney, Agent, or Firm—Sughrue, Mion, Zinn, Macpeak & Seas

[\*\*] Term: 14 Years

[57] CLAIM

[21] Appl. No.: 850,902

The ornamental design for a miniature rechargeable pocket lamp, as shown and described.

[22] Filed: Apr. 8, 1986

DESCRIPTION

[52] U.S. Cl. .... D26/46

[58] Field of Search ..... D26/37-50; 362/157, 158, 183-191, 194-208, 103

FIG. 1 is a perspective view of a miniature rechargeable pocket lamp showing my new design; FIG. 2 is an exploded, perspective view thereof, with a clip mounted plug detached therefrom; FIG. 3 is a top plan view thereof; FIG. 4 is a front elevational view thereof; FIG. 5 is a side elevational view thereof, the opposite side being a mirror image thereof; FIG. 6 is a rear elevational view thereof; and FIG. 7 is a bottom plan view thereof.

[56] References Cited

U.S. PATENT DOCUMENTS

- D. 210,905 4/1968 Kahn ..... D26/37
- 1,552,404 9/1925 Allen ..... D26/38 X
- 2,528,701 11/1950 Mitchell ..... D26/37 X
- 2,679,575 5/1954 Haberstump ..... 362/194 X

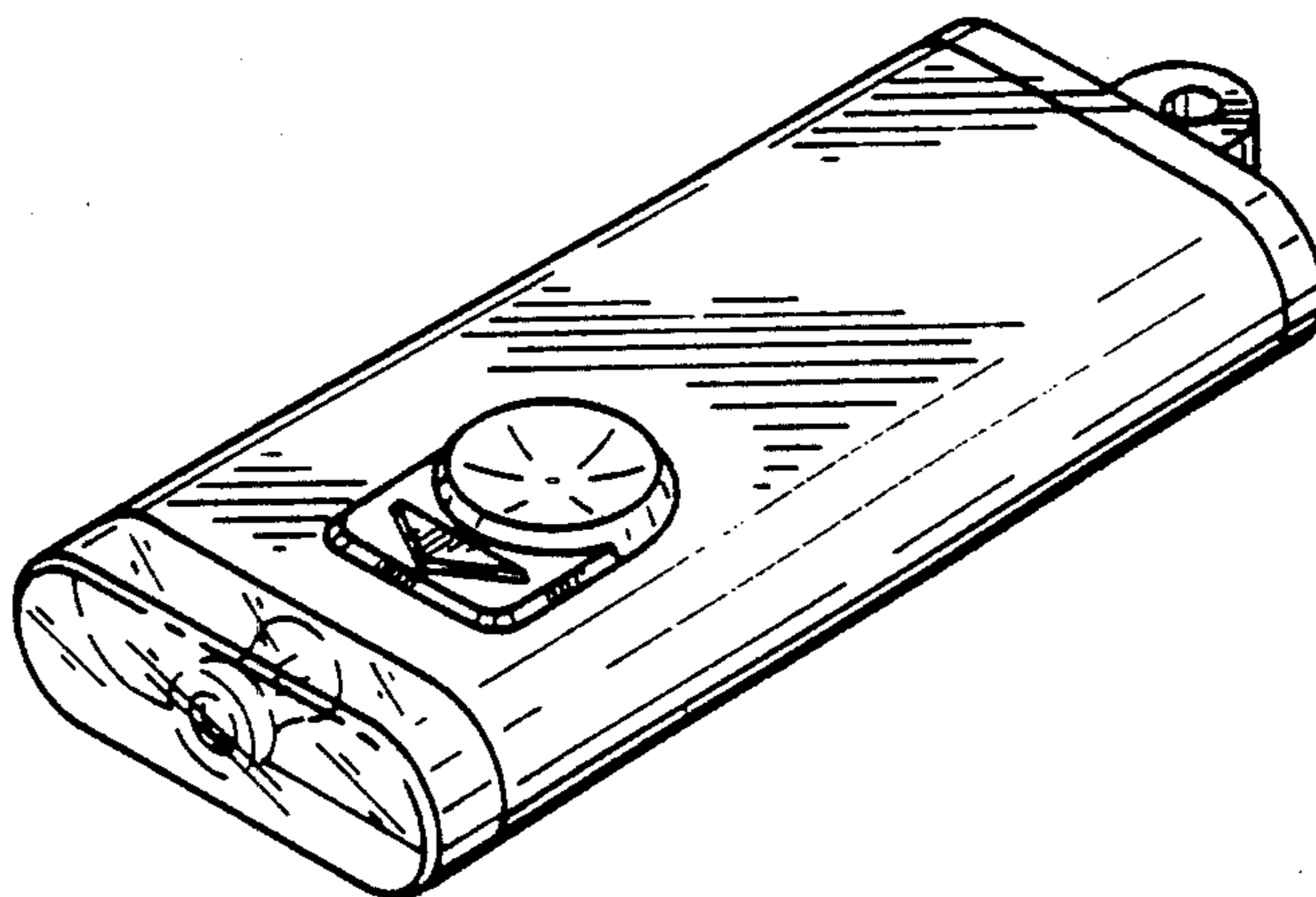

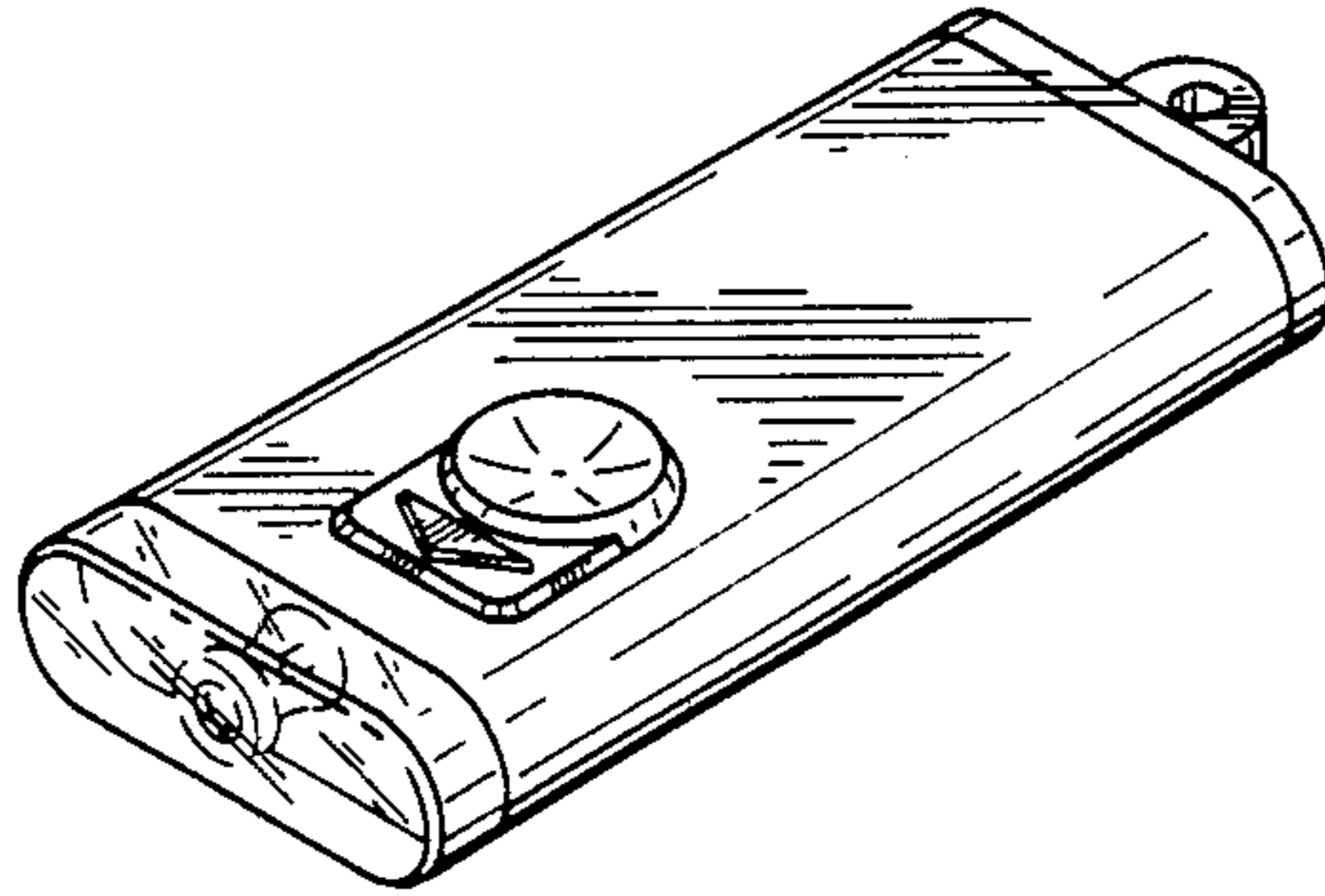

FIG. 1

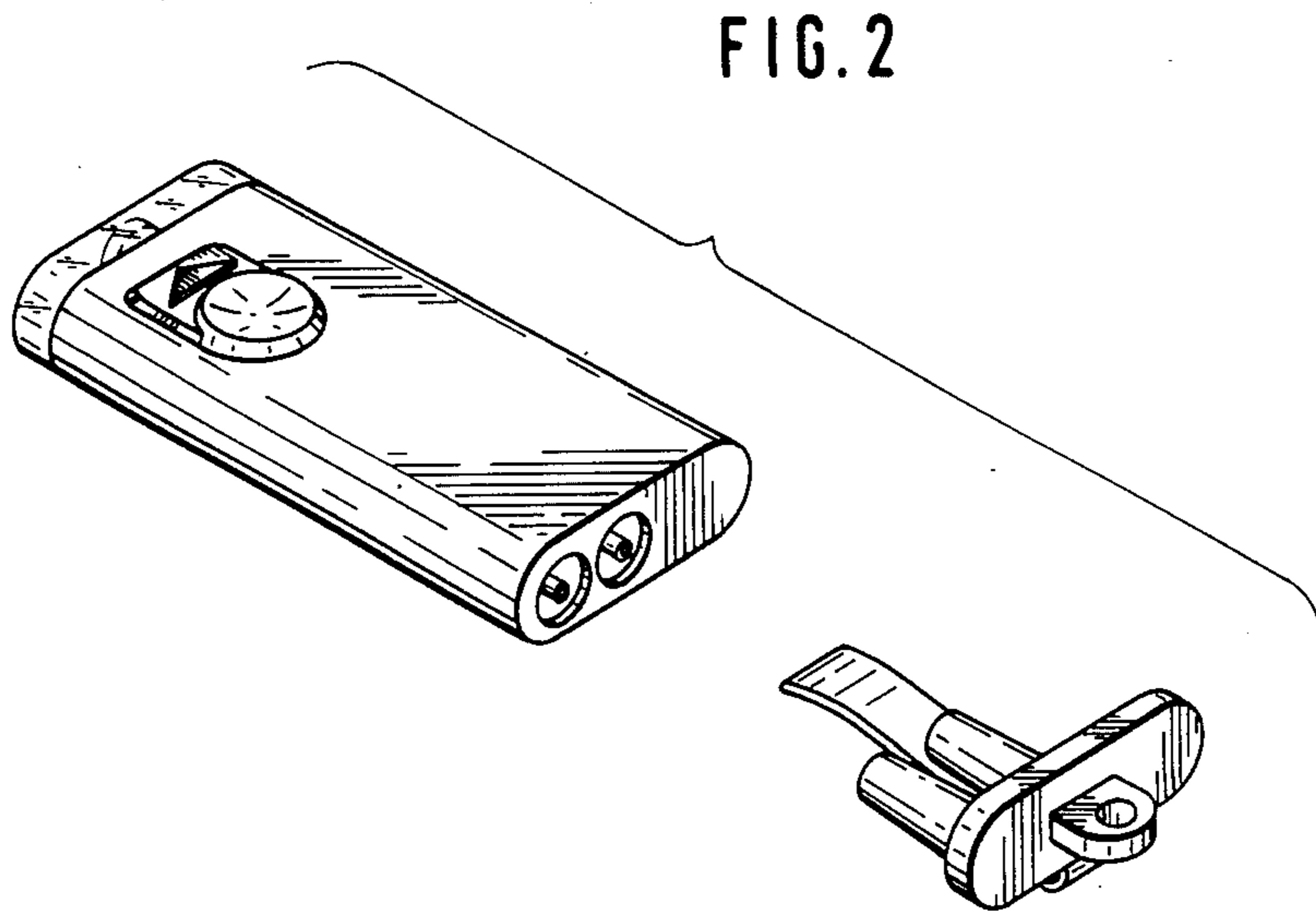

FIG. 2

FIG. 3

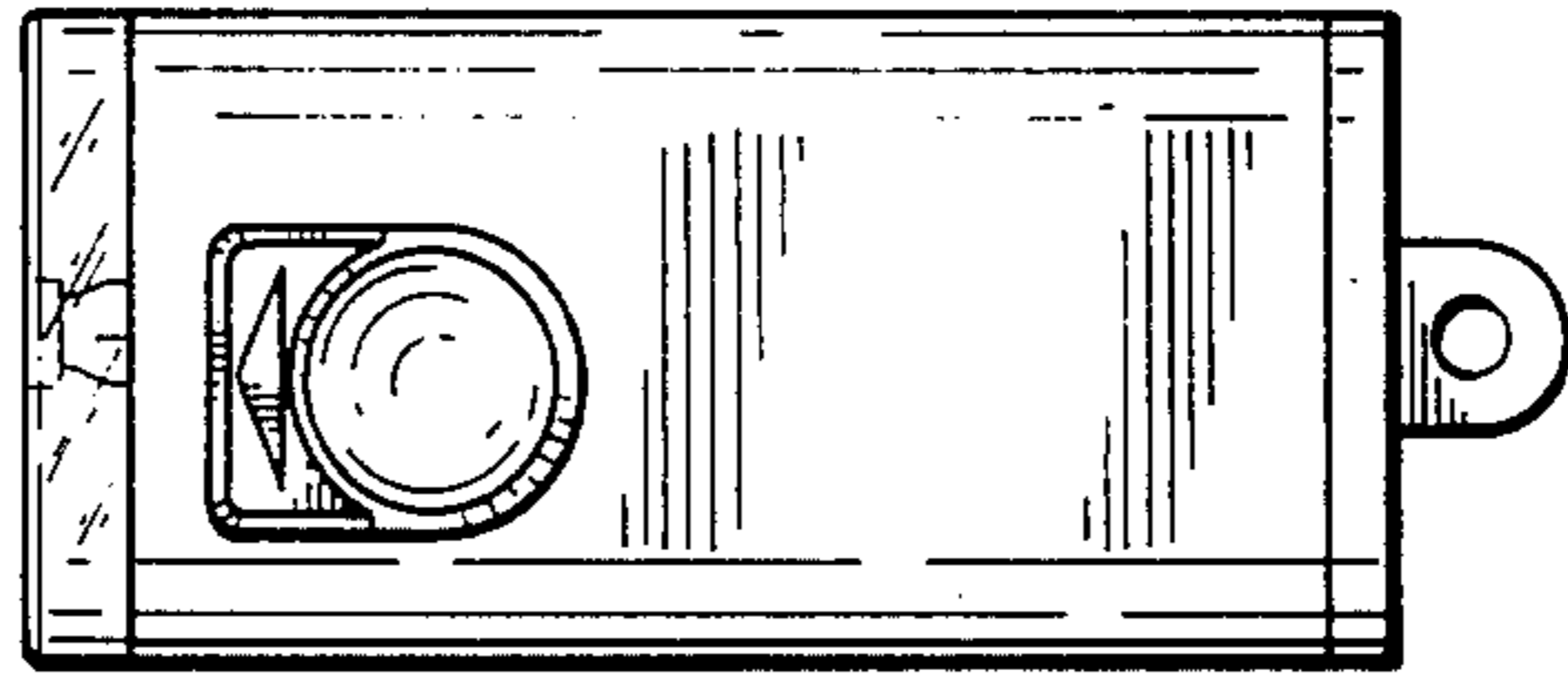

FIG. 4

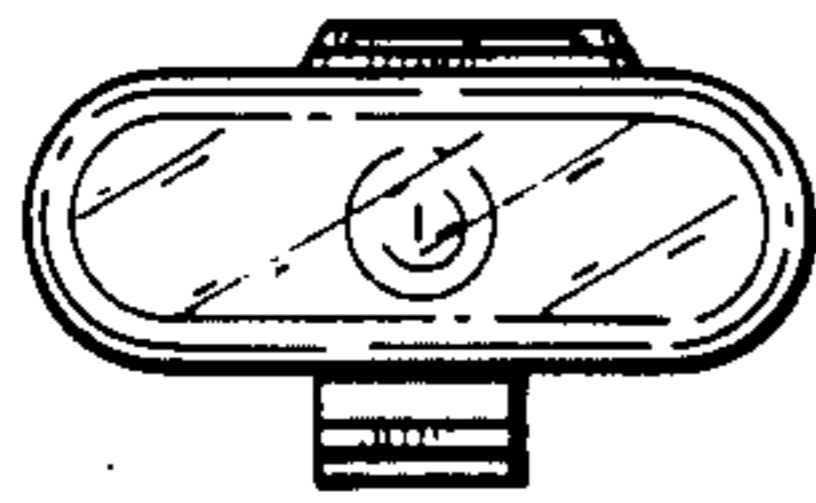

FIG. 5

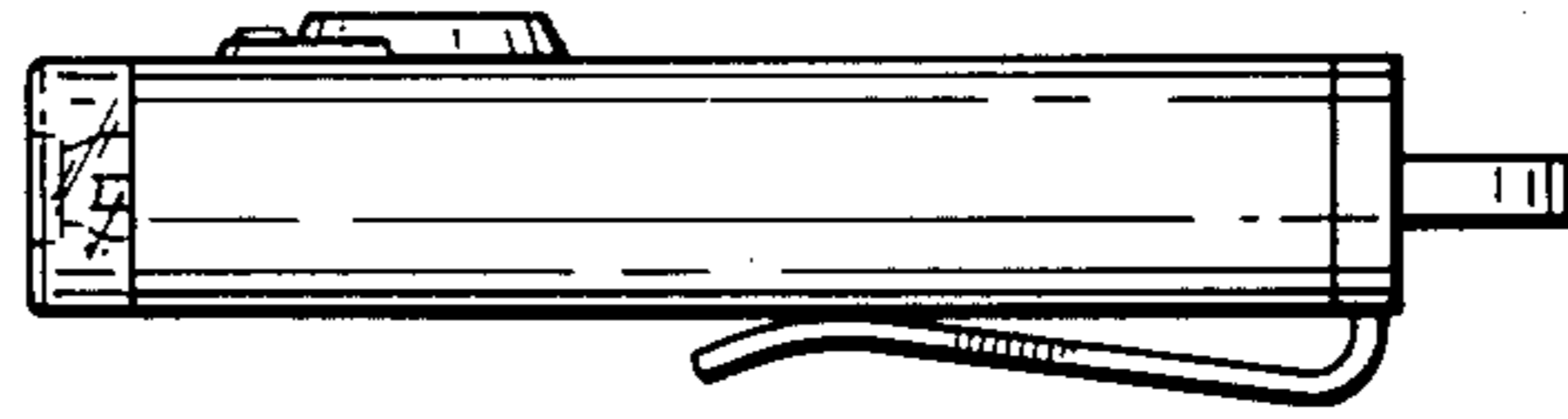

FIG. 6

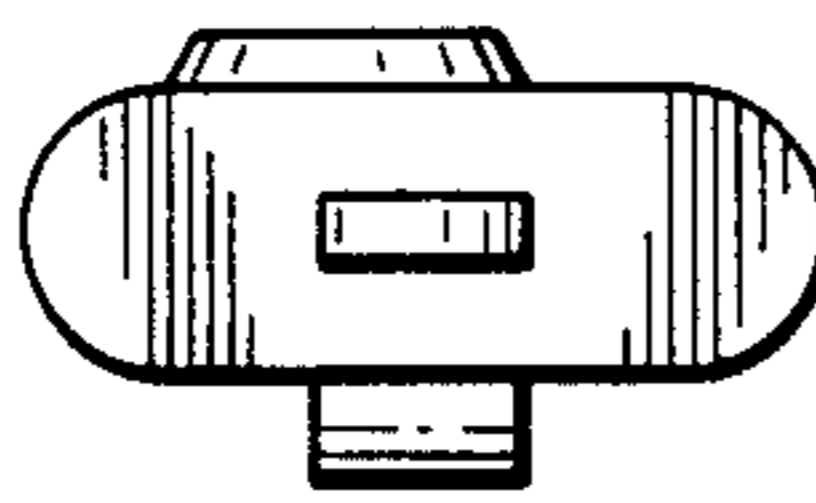

FIG. 7

