

United States Patent [19]

Lanoue

[11] Patent Number: **Des. 298,849**

[45] Date of Patent: **** Dec. 6, 1988**

[54] CAP FOR SAP COLLECTING UNIT

4,688,829 8/1987 Shioda et al. 285/156

[75] Inventor: Michel Lanoue, Ste-Foy, Canada

Primary Examiner—James R. Largen
Attorney, Agent, or Firm—Jean H. Dubuc

[73] Assignee: Les Industries Provinciales LTEE, St. Damien, Canada

[57] **CLAIM**

[**] Term: 14 Years

The ornamental design for a cap for sap collecting unit, as shown and described.

[21] Appl. No.: 784,944

DESCRIPTION

[22] Filed: Oct. 7, 1985

[52] U.S. Cl. D23/260

[58] Field of Search D23/259-269;
285/38

FIG. 1 is a top, perspective view of a cap for sap collecting unit showing my new design;

FIG. 2 is a side elevational view thereof;

FIG. 3 is a side elevational view thereof, at 90° from the view shown in FIG. 2;

FIG. 4 is a top plan view thereof;

FIG. 5 is a bottom plan view thereof; and

FIG. 6 is a cross-sectional view thereof taken along line 6—6 in FIG. 4.

[56] **References Cited**

U.S. PATENT DOCUMENTS

D. 240,928 8/1976 Motivier et al. D23/238

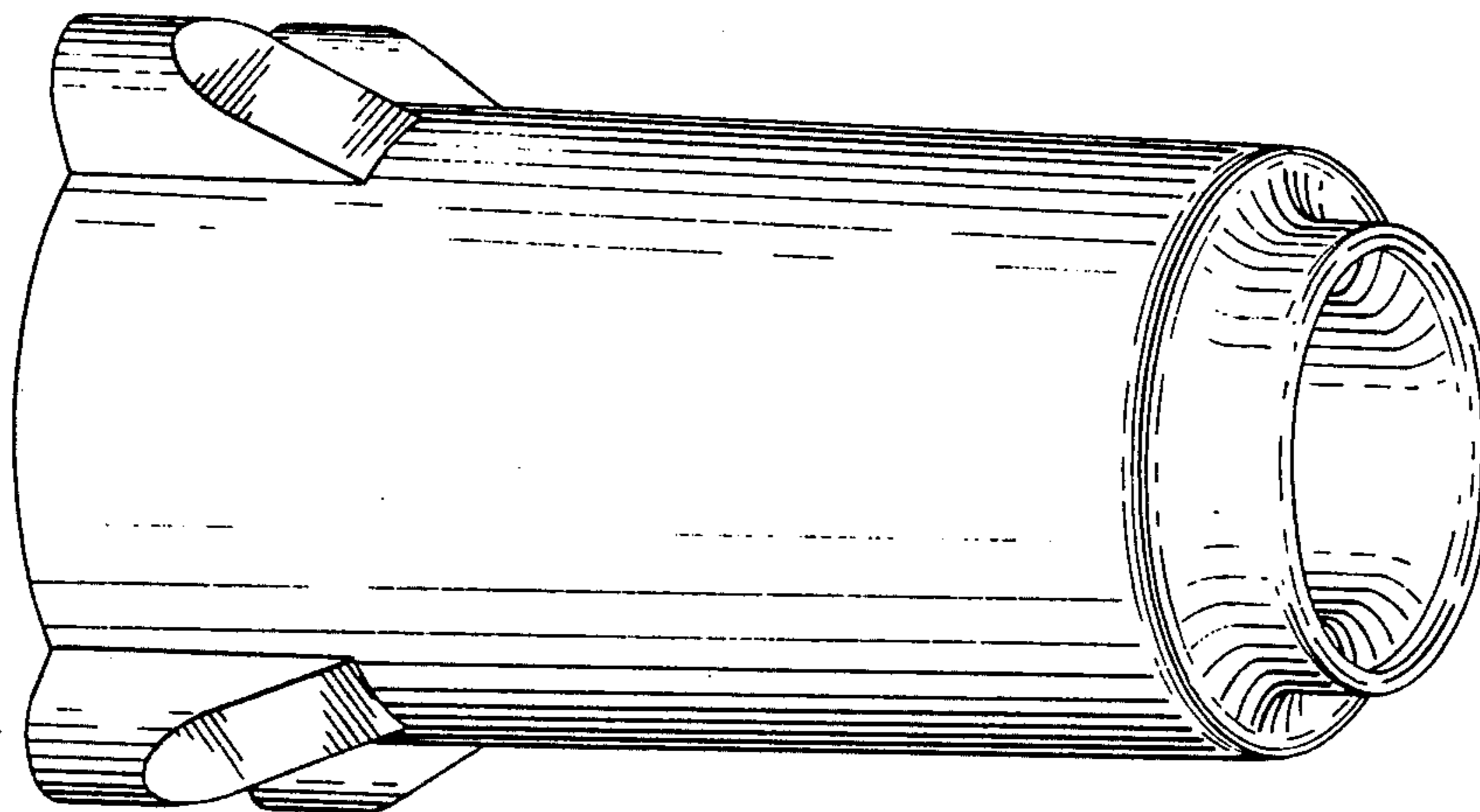

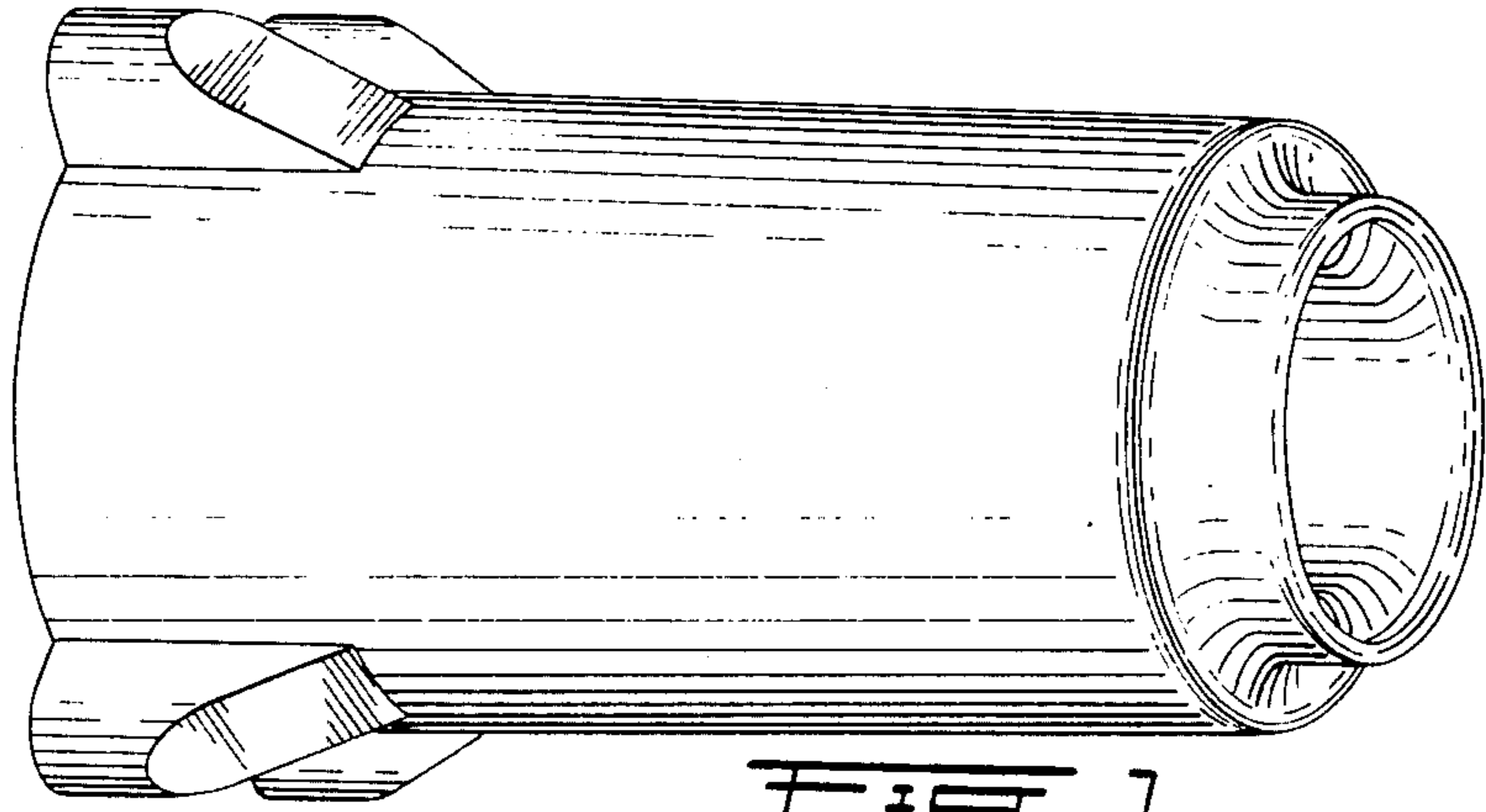

FIG. 1

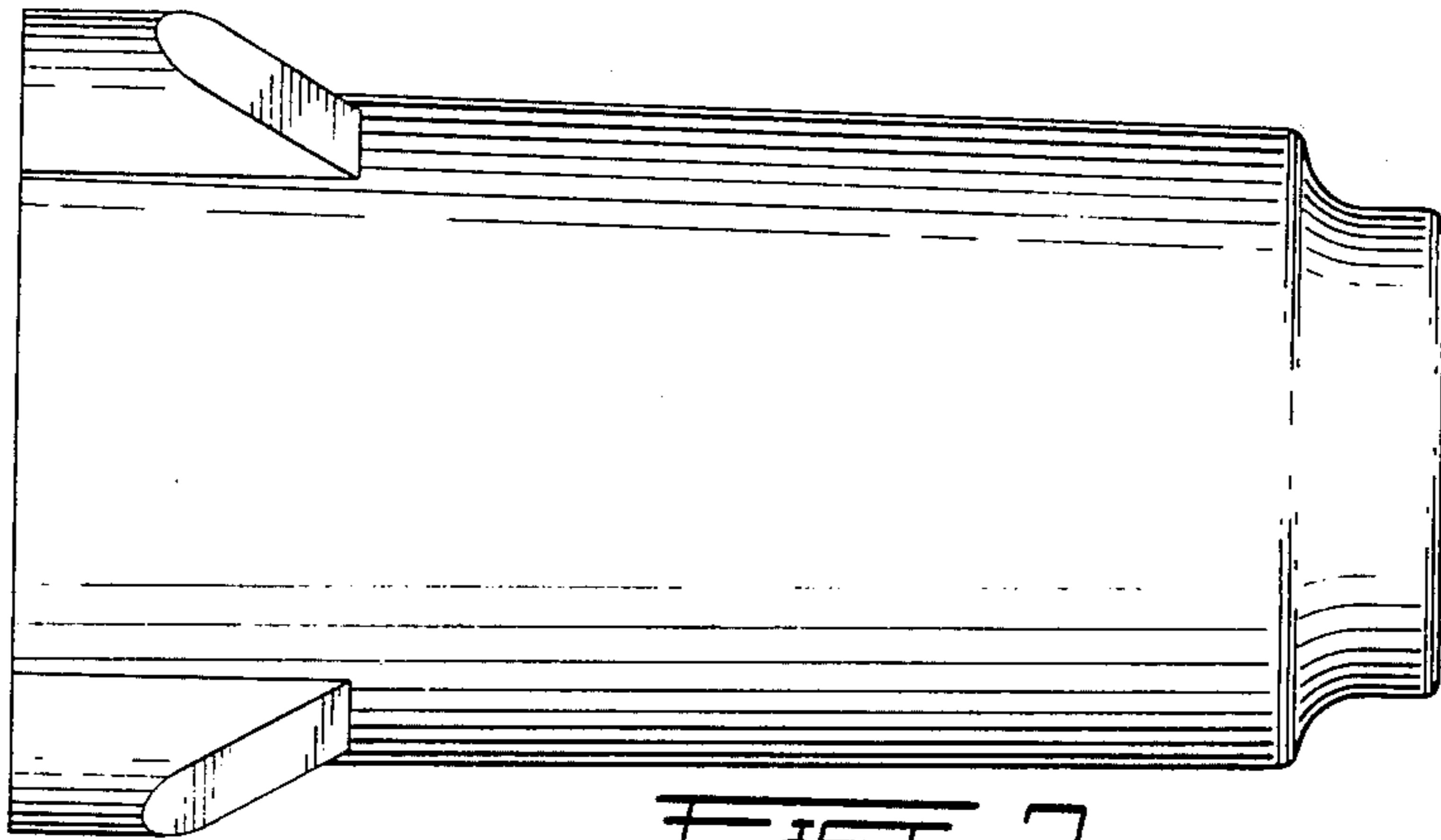

FIG. 2

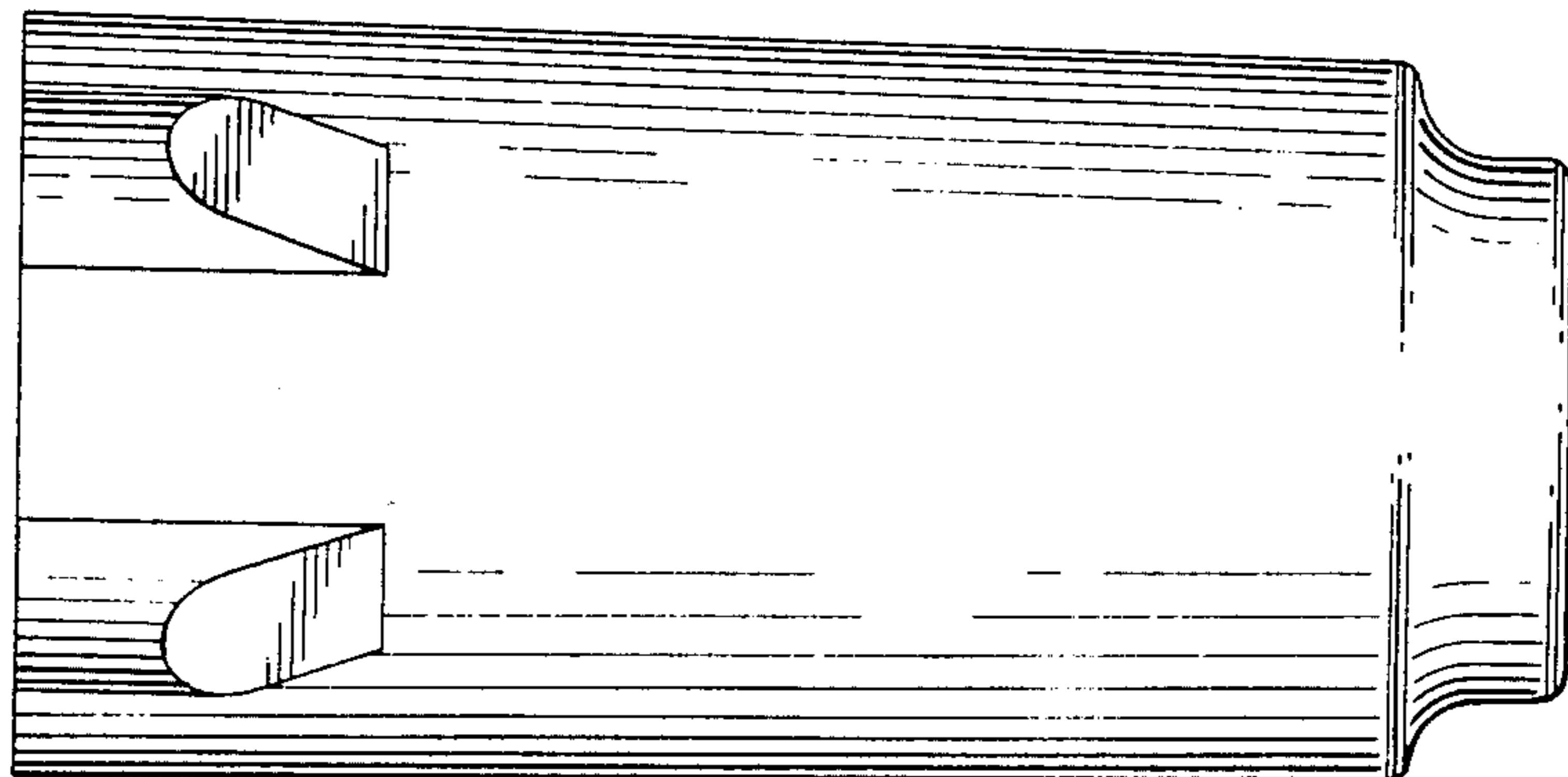

FIG. 3

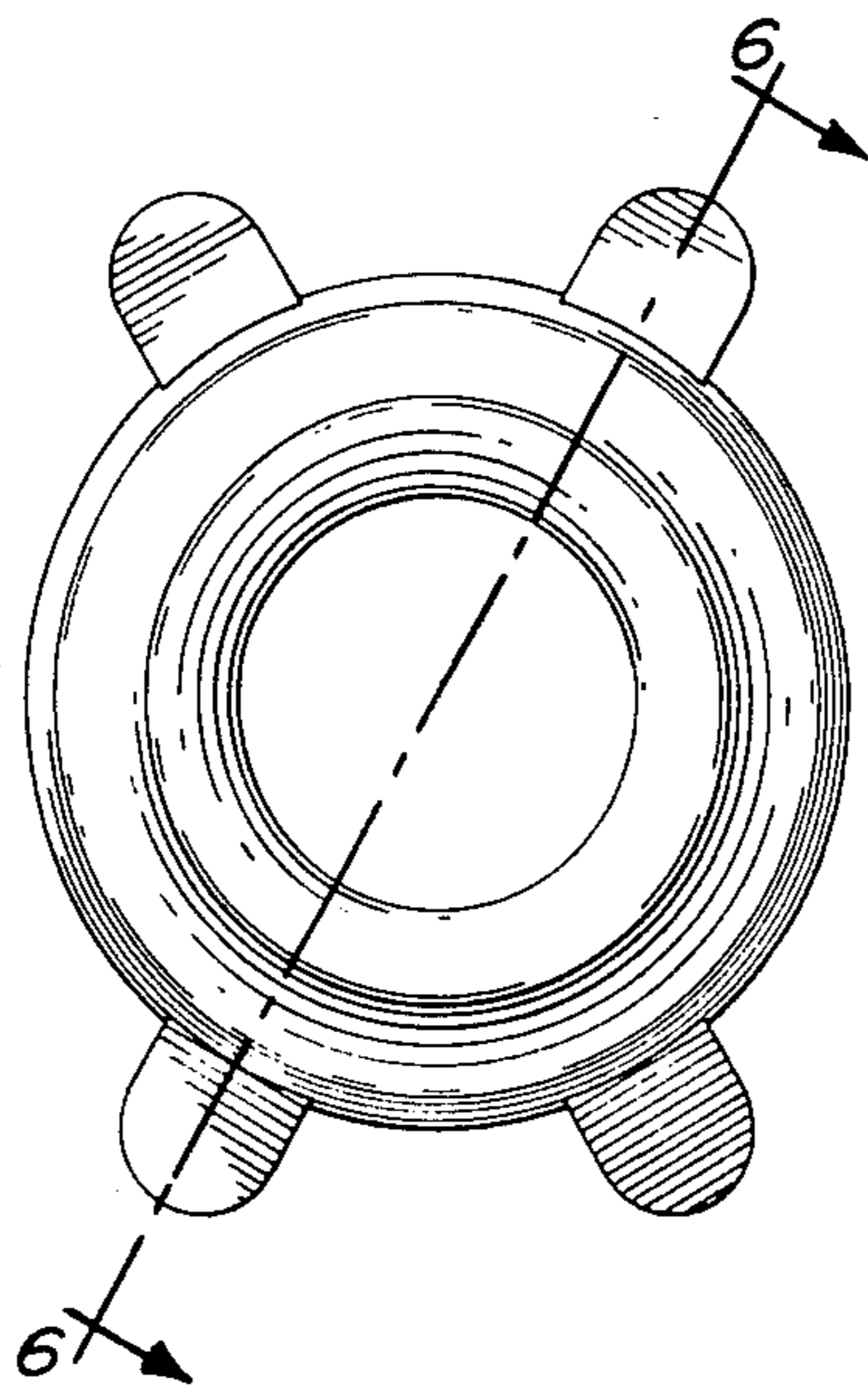

FIG. 4

FIG. 5

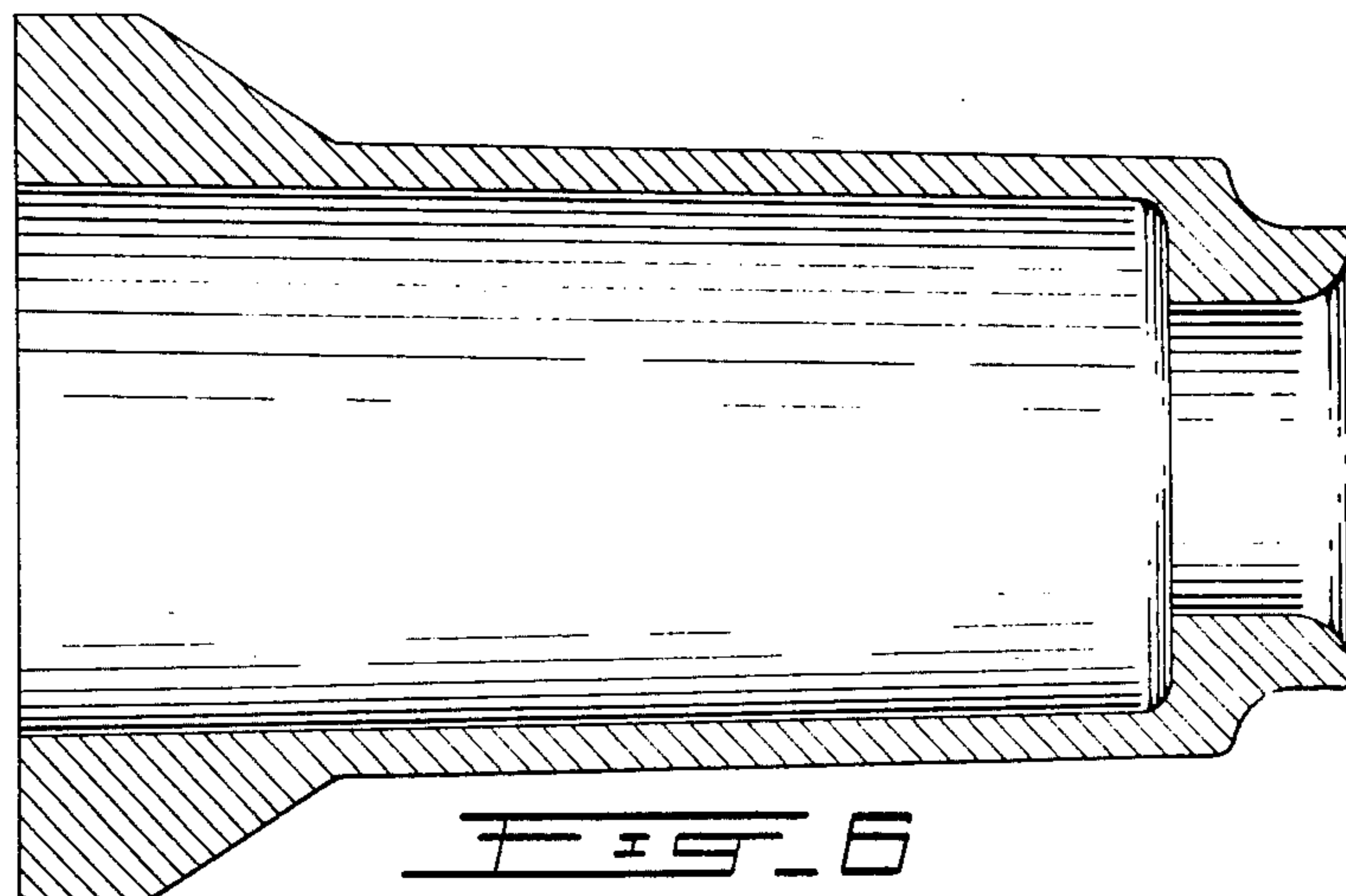
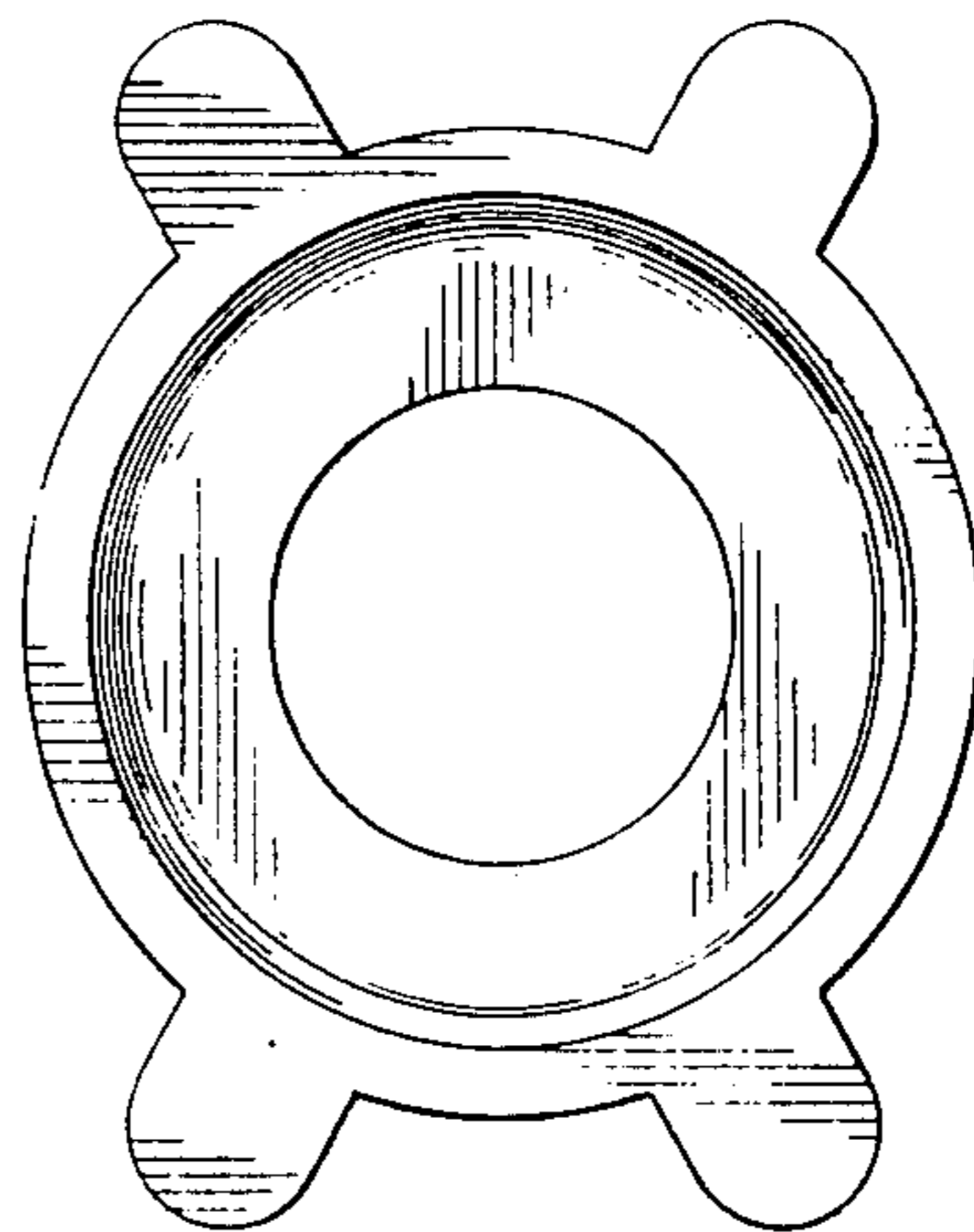

FIG. 6