

[54] COMBINATION TELEPHONE HANDSET AND STAND WITH DIALING MEANS

[75] Inventors: Guillermo F. Brignole, Pasadena; Robert E. Lee, Solana Beach, both of Calif.

[73] Assignee: TeleQuest, Inc., San Diego, Calif.

[**] Term: 14 Years

[21] Appl. No.: 19,293

[22] Filed: Feb. 26, 1987

[52] U.S. Cl. D14/53; D14/63; D14/62

[58] Field of Search D14/53, 56, 58, 62, D14/61, 63, 64, 101; 379/428, 440, 433, 434, 436, 435, 419

[56] References Cited

U.S. PATENT DOCUMENTS

- D. 211,472 6/1968 Dreyfuss D14/53
- D. 211,738 7/1968 Dreyfuss D14/53
- D. 267,007 11/1982 Chiou D14/101
- D. 282,545 2/1986 Icade et al. D14/58
- D. 286,404 10/1986 Skigen et al. D14/63
- D. 287,124 12/1986 Becker D14/60 X
- D. 287,964 1/1987 Perkins D14/60 X
- D. 292,207 10/1987 Okada D14/63 X
- D. 293,783 1/1988 Martinez D14/63 X
- D. 294,695 3/1988 Endt D14/62 X
- D. 294,826 3/1988 Yoshihanu D14/53

FOREIGN PATENT DOCUMENTS

- 0116257 6/1985 Japan 379/428

OTHER PUBLICATIONS

B. A. Pargh Co., Inc., 1985-86 cat., Group 290 at p. 327, Manta-Designer Telequest 150FTFTLQ.

Primary Examiner—Horace B. Fay
Attorney, Agent, or Firm—Spensley Horn Jubas & Lubitz

[57] CLAIM

The ornamental design for combination telephone handset and stand with dialing means, as shown and described.

DESCRIPTION

FIG. 1 is a front, top and right side perspective view of a combination telephone handset and stand with dialing means showing our new design in cradled relationship; FIG. 2 is a top plan view thereof; FIG. 3 is a right side elevational view thereof; FIG. 4 is a bottom plan view thereof; FIG. 5 is a front elevational view thereof; FIG. 6 is a rear elevational view thereof; FIG. 7 is a left side elevational view thereof; FIG. 8 is a front, top and right side perspective view of the base of the telephone of our new design with the handset removed and a front, right side and bottom perspective view of the handset; FIG. 9 is a top plan view of stand alone; FIG. 10 is a right side elevational view of the handset; FIG. 11 is a bottom plan view thereof; FIG. 12 is a front elevational view thereof; and FIG. 13 is a rear elevational view thereof. The structure shown in broken lines is not part of the design sought to be patterned. The broken line showing of cord in FIGS. 1-4, 7-9 is for illustrative purposes only and forms no part of the claimed design.

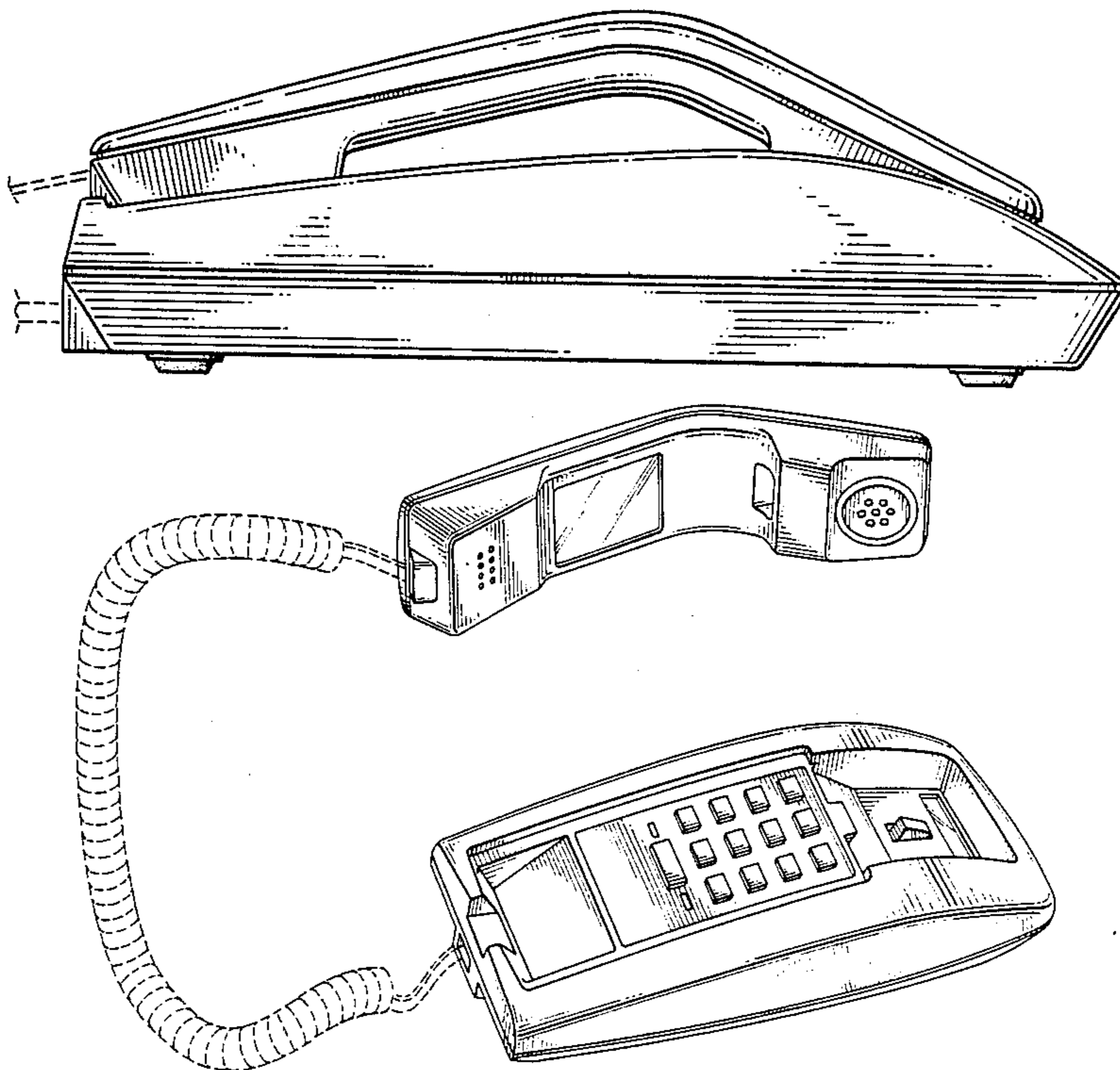

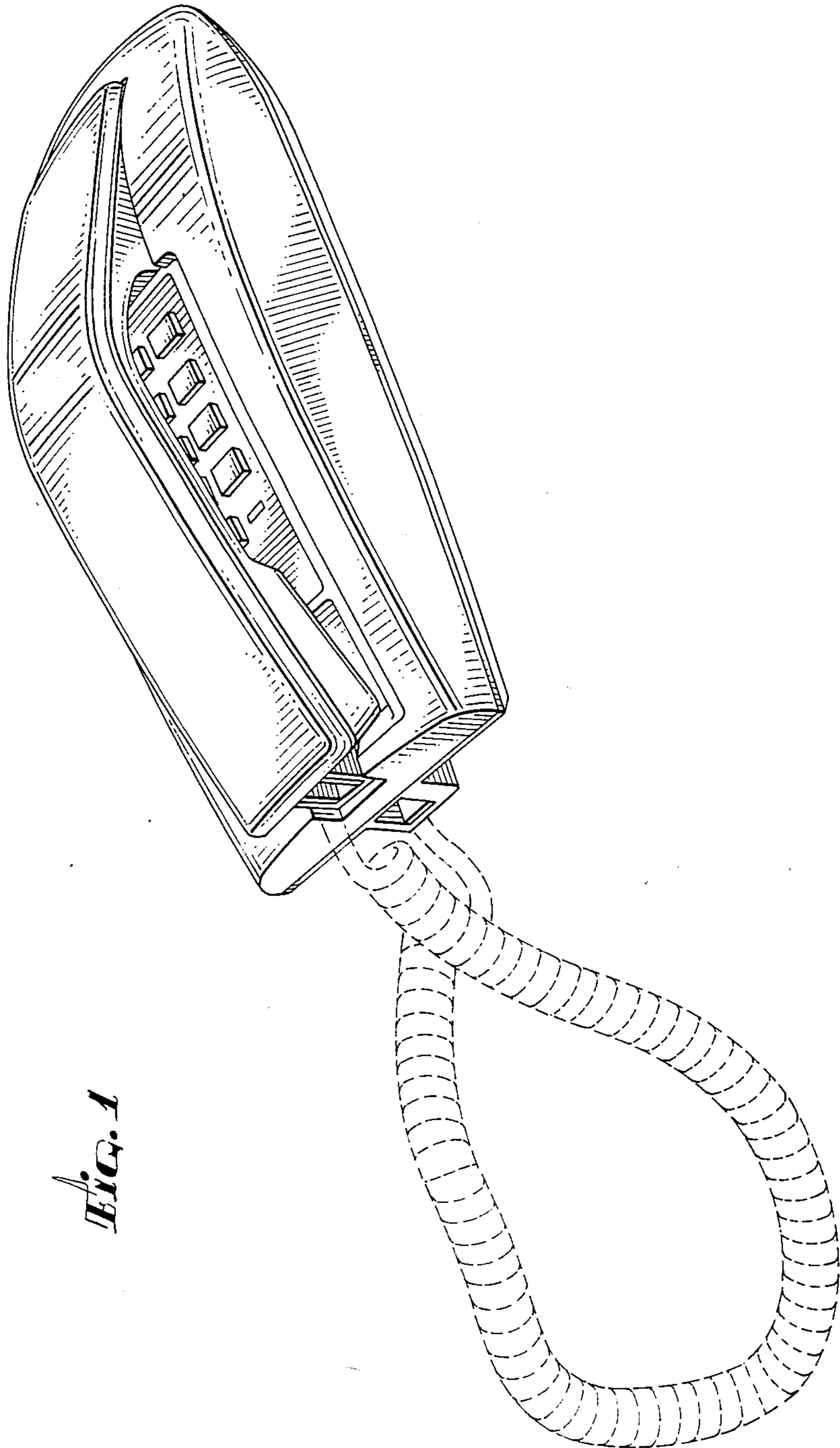

FIG. 1

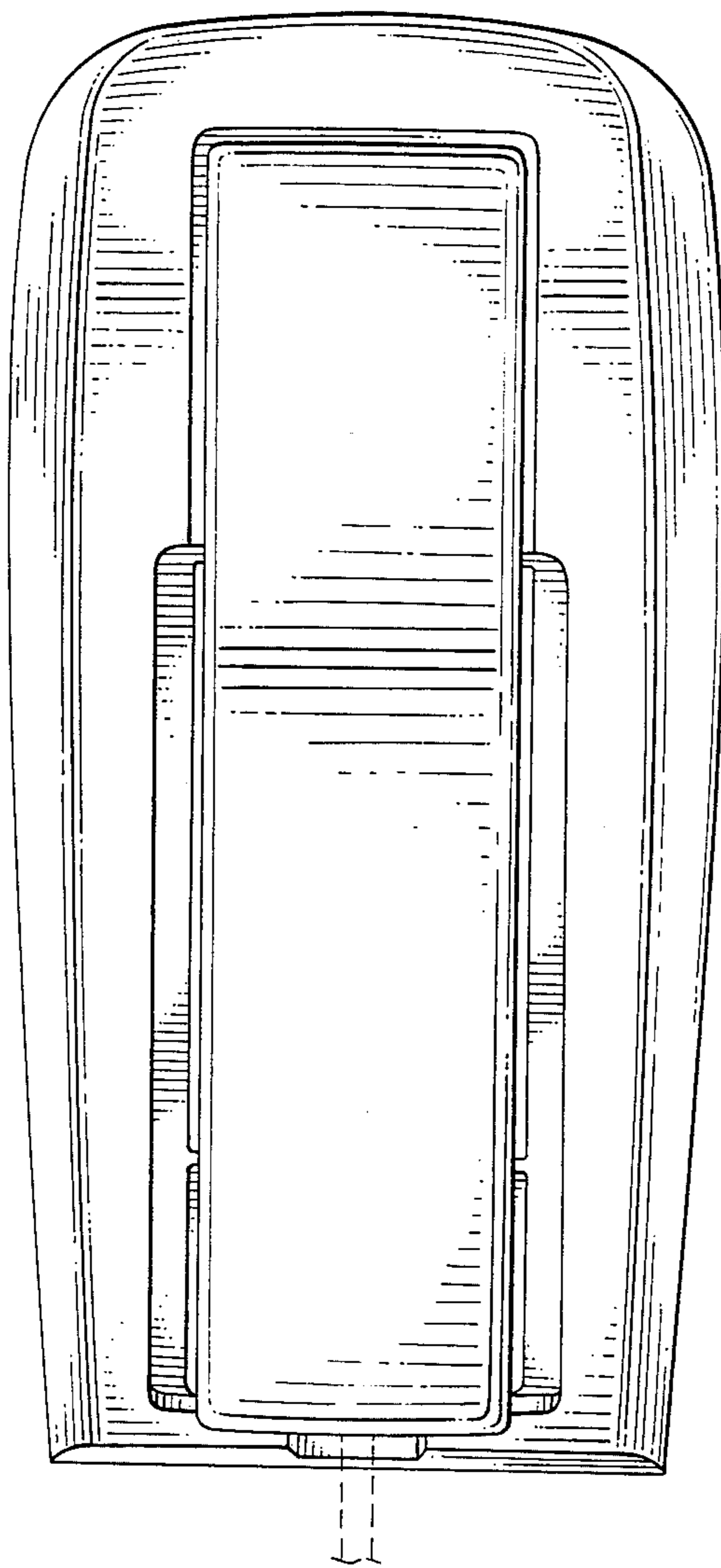

FIG. 2

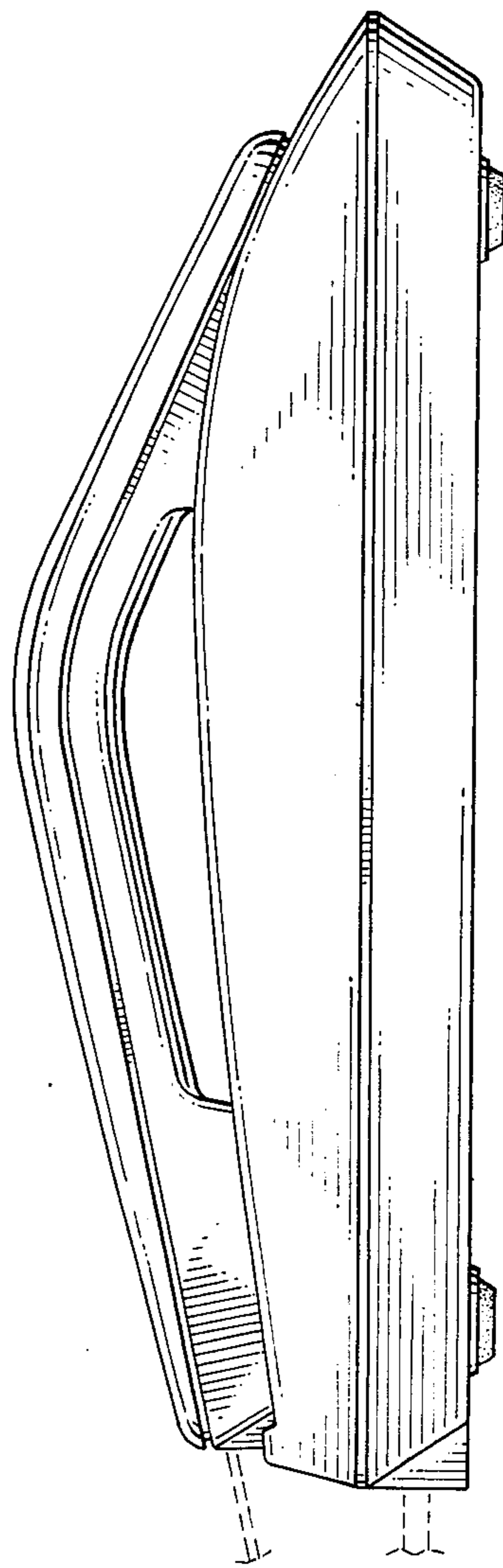
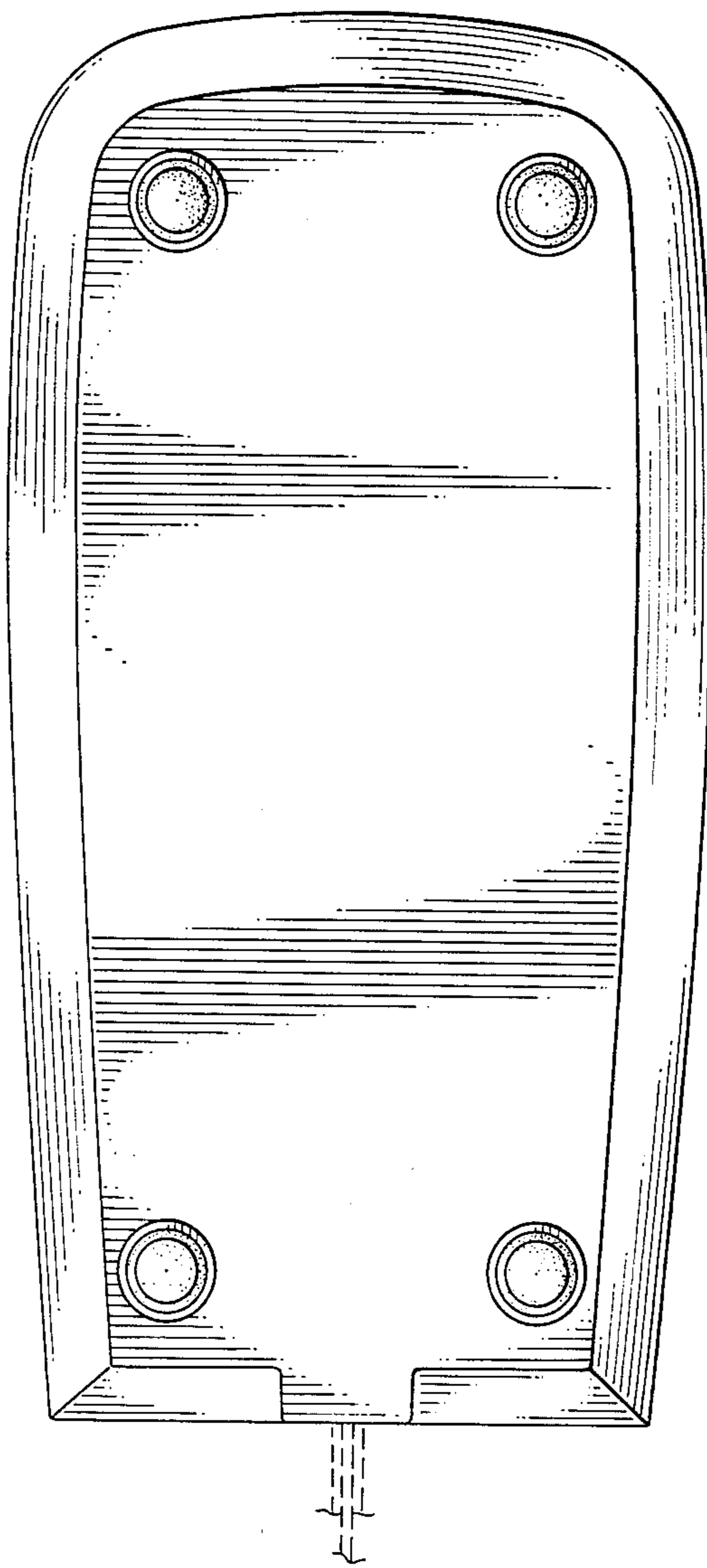

FIG. 3

FIG. 4



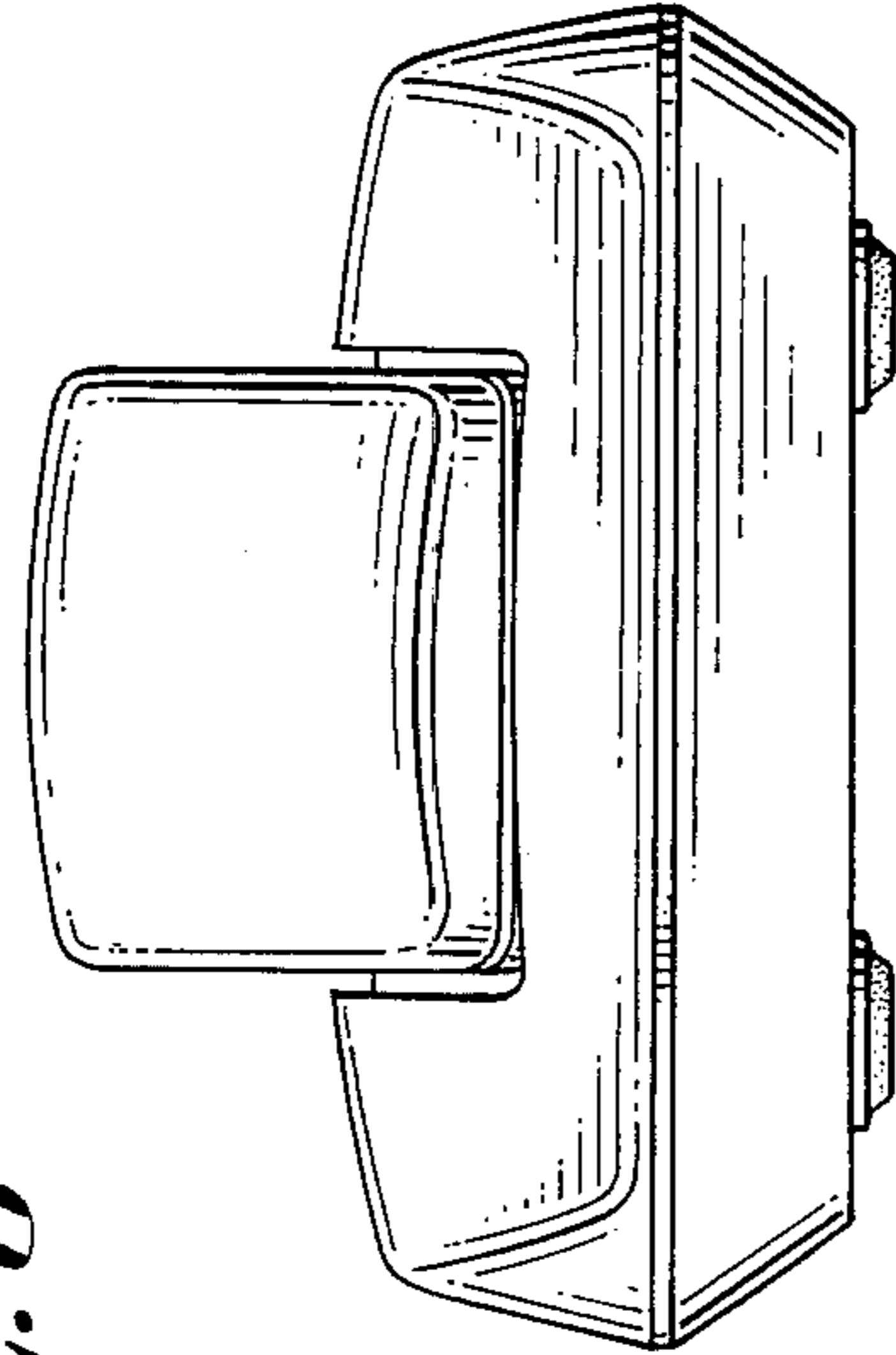

FIG. 6

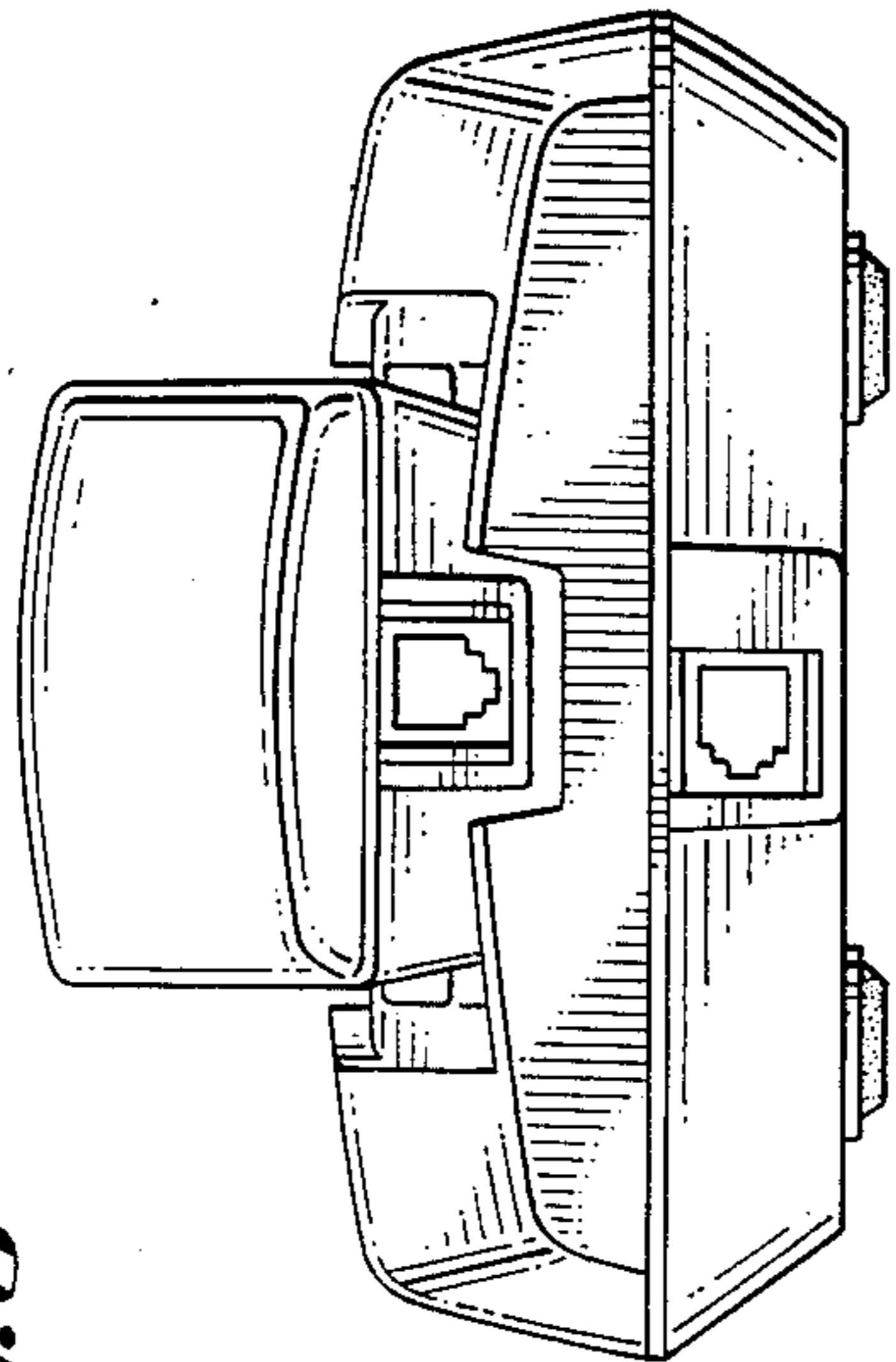

FIG. 5

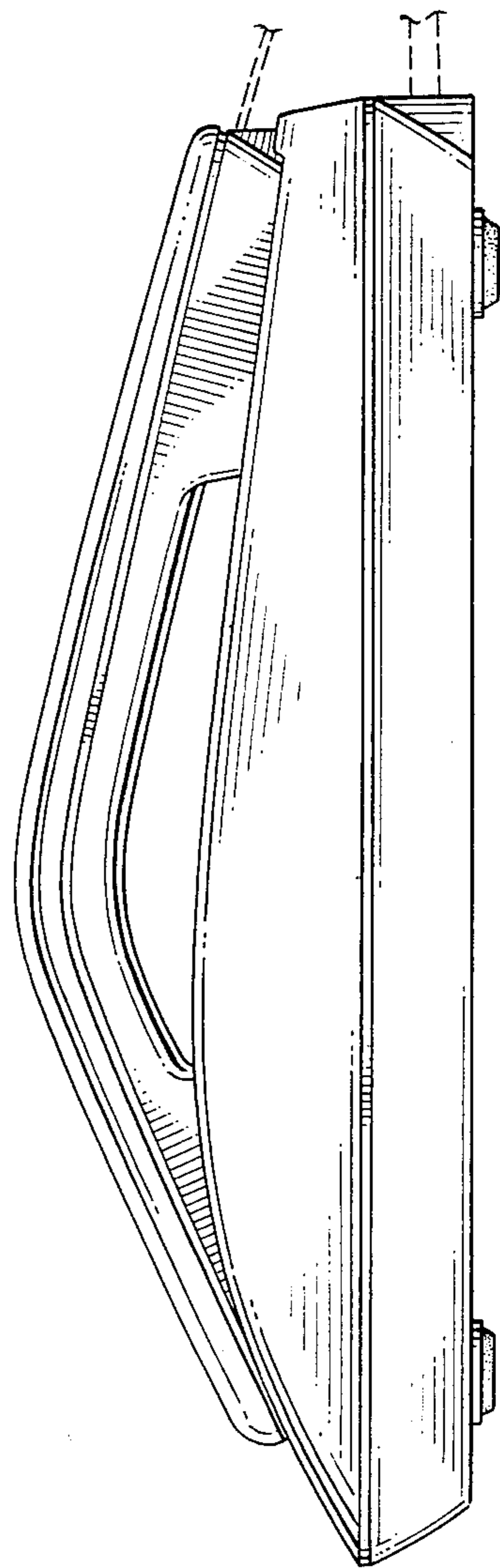

FIG. 7

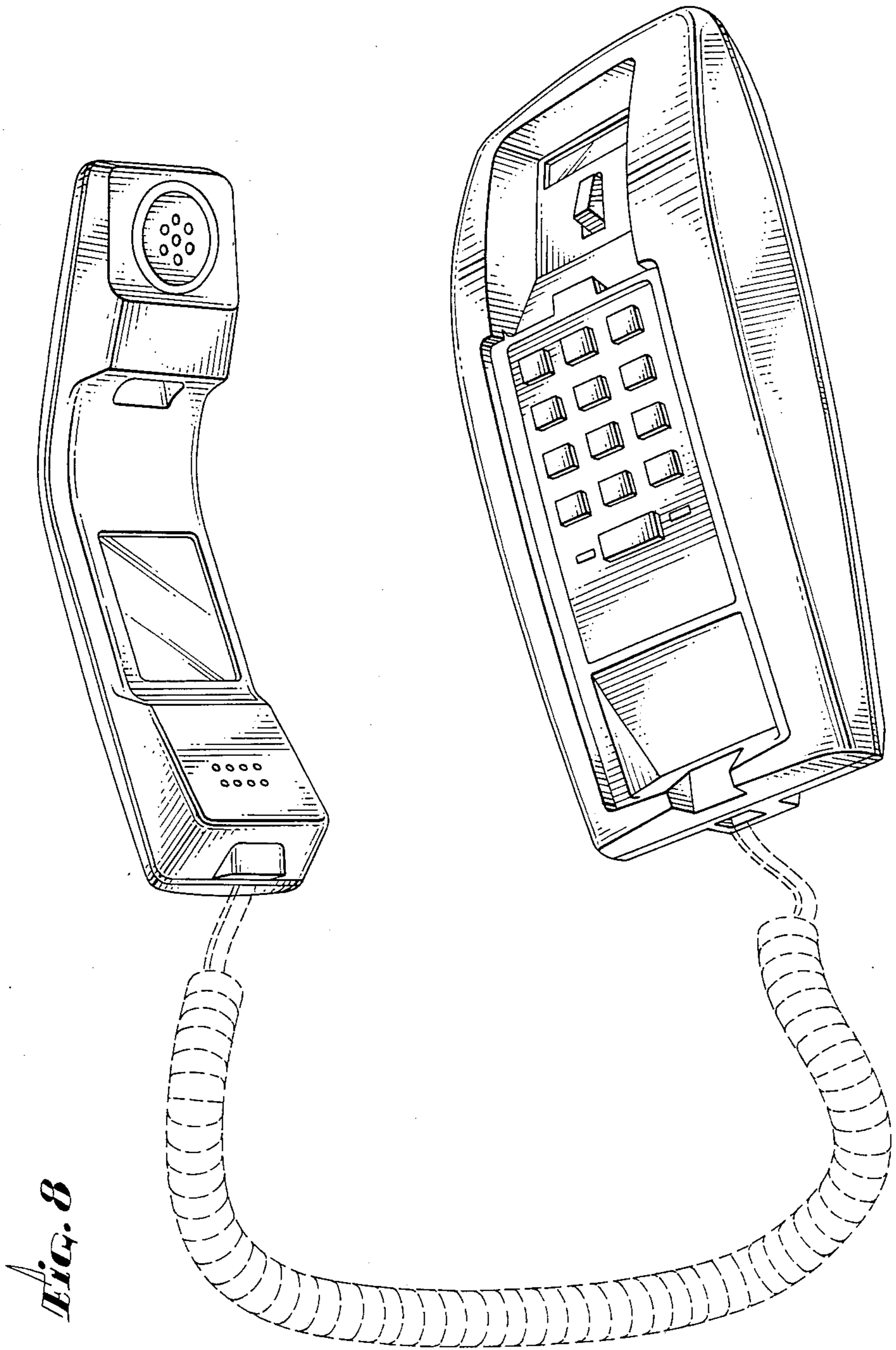

FIG. 8

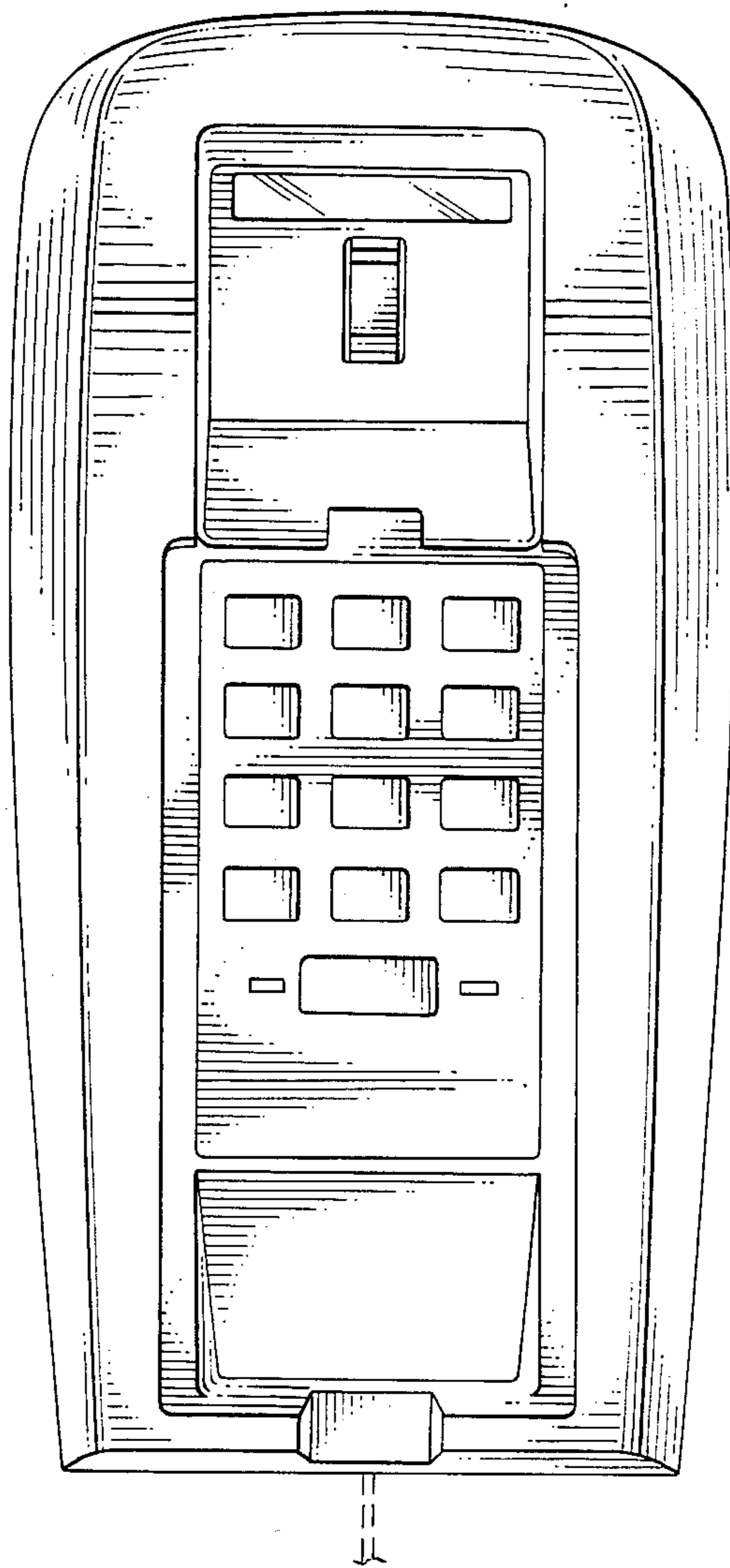

FIG. 9

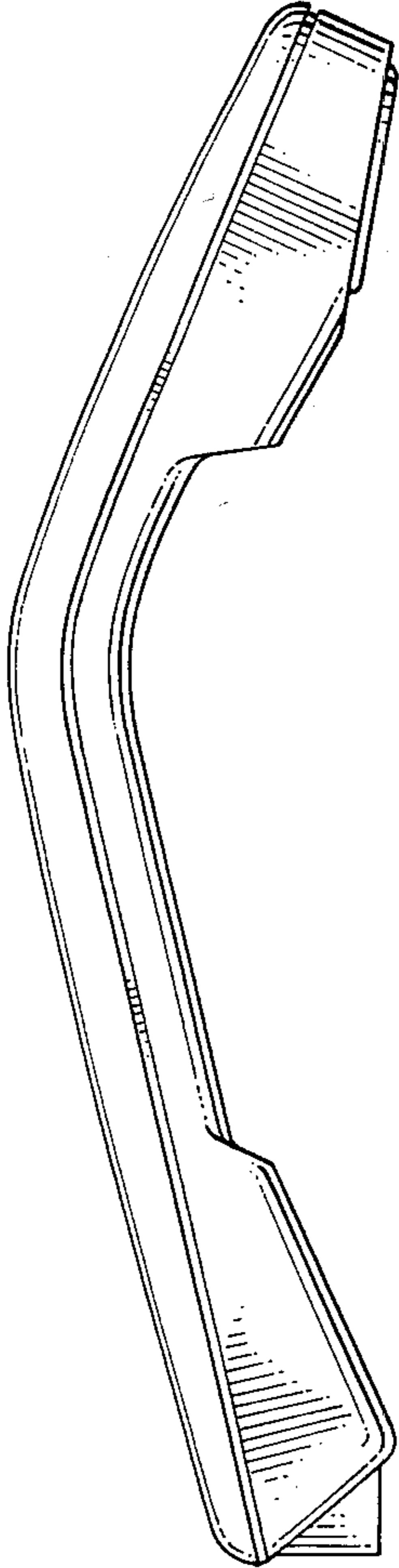

FIG. 10

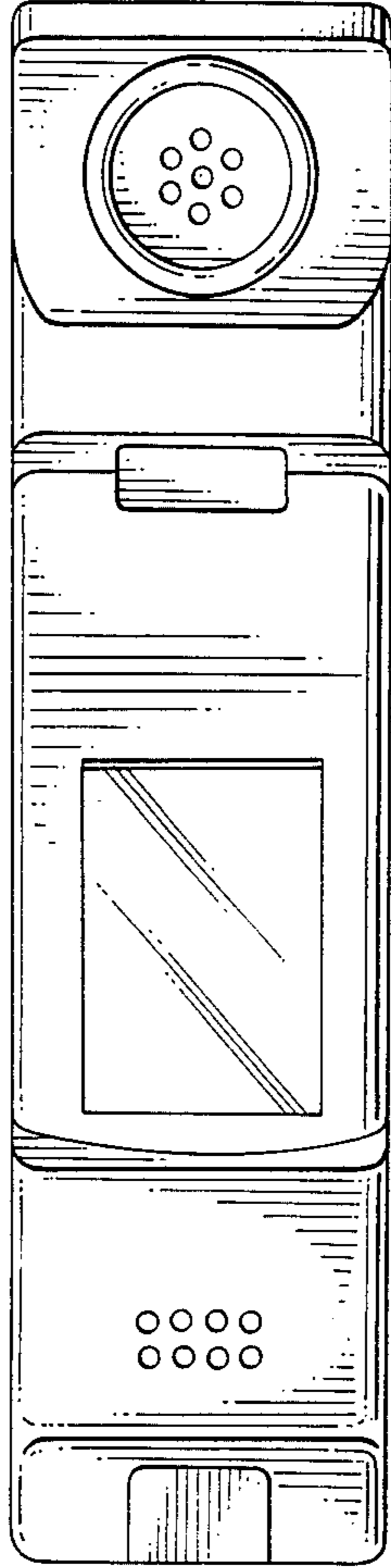

FIG. 11

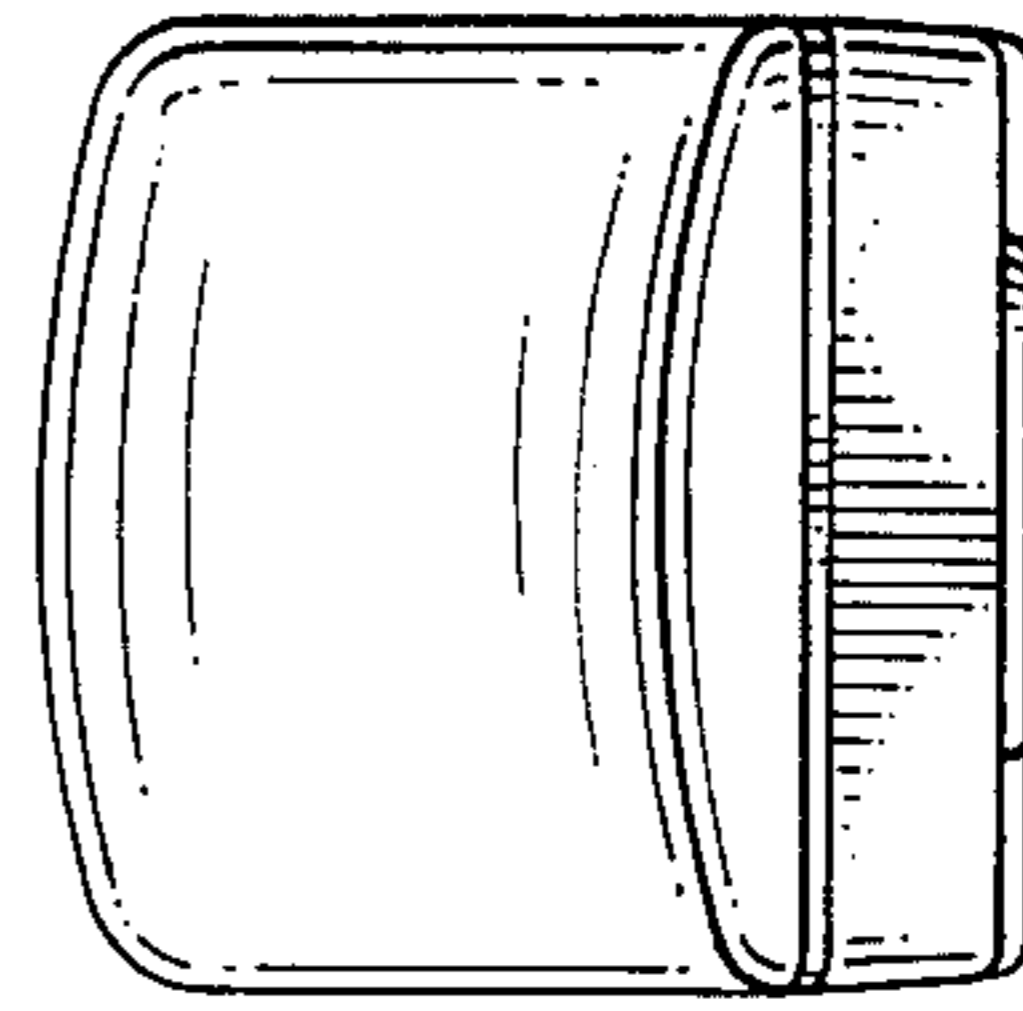

FIG. 12

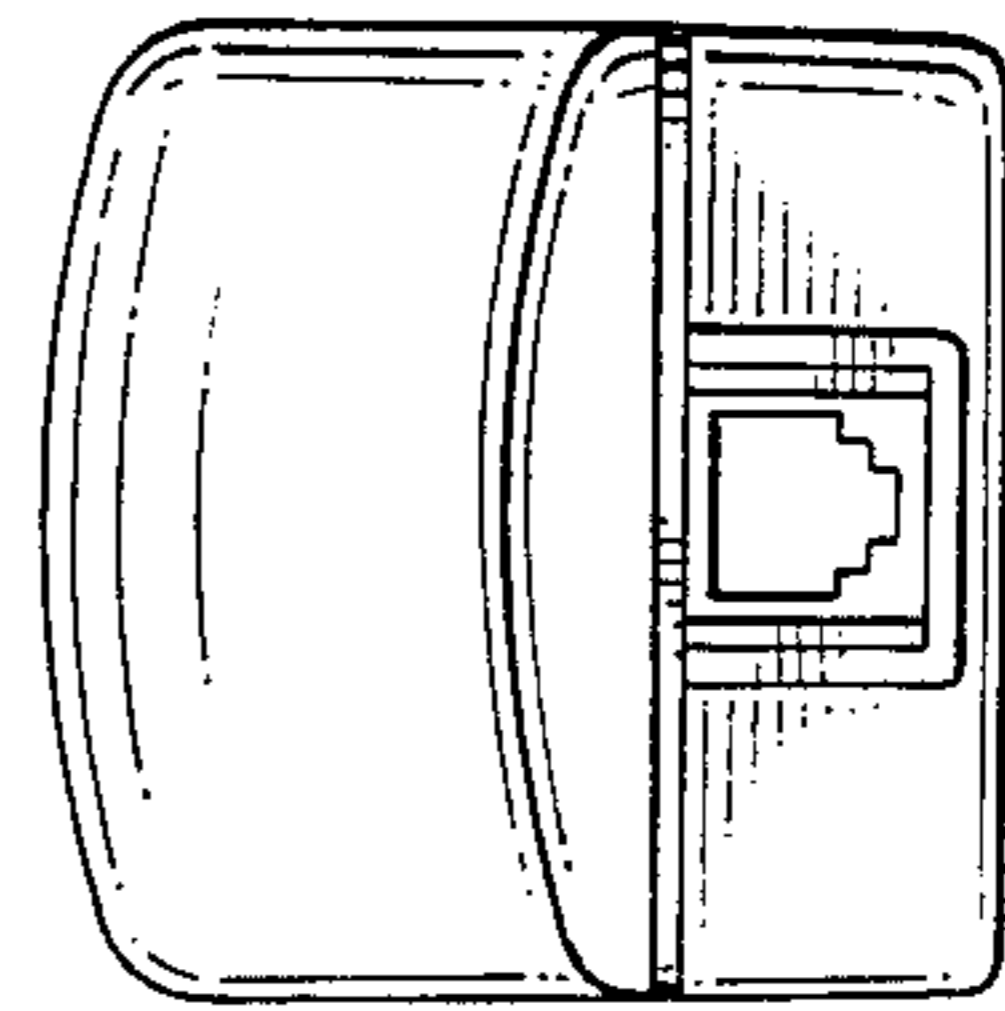

FIG. 13