

[54] **HOLDER FOR PENS, PENCILS AND THE LIKE**

[76] Inventor: **Stephen H. Wolff, 222 E. 35th St., New York, N.Y. 10016**

[**] Term: **14 Years**

[21] Appl. No.: **785,273**

[22] Filed: **Oct. 7, 1985**

[52] U.S. Cl. **D19/85**

[58] Field of Search **D19/20-25, D19/75-85, 90-92; 206/214**

[56] **References Cited**

U.S. PATENT DOCUMENTS

D. 177,160	3/1956	Vernon	D19/85
D. 248,441	7/1978	Bausch	D19/85
D. 253,483	11/1979	Thuringer	D19/83
D. 289,060	3/1987	Wolff	D19/85

Primary Examiner—Charles Rademaker
Attorney, Agent, or Firm—Jacobs & Jacobs

[57] **CLAIM**

The ornamental design for a holder for pens, pencils and the like, as shown and described.

DESCRIPTION

FIG. 1 is perspective view of a holder for pencils, pens and the like showing my new design;
 FIG. 2 is a front elevational view;
 FIG. 3 is a bottom plan view, partly broken away;
 FIG. 4 is a rear elevational view;
 FIG. 5 is top plan view;
 FIG. 6 is a right side elevational view, the left side being the mirror image thereof;
 FIG. 7 is a view in section taken along lines 7—7 in FIG. 3;
 FIG. 8 is a perspective view of a modified embodiment of the design shown in FIGS. 1 through 7;
 FIG. 9 is a front elevational view;
 FIG. 10 is bottom plan view, partly broken away;
 FIG. 11 is a rear elevational view;
 FIG. 12 is top plan view;

FIG. 13 is a right side elevational view, the left side being the mirror image thereof;
 FIG. 14 is a view in section taken along lines 14—14 in FIG. 10;
 FIG. 15 is a perspective view of a second modified embodiment of the design shown in FIGS. 1 through 7;
 FIG. 16 is a front elevational view;
 FIG. 17 is a bottom plan view, partly broken away;
 FIG. 18 is a rear elevational view;
 FIG. 19 is top plan view;
 FIG. 20 is a right side elevational view, the left side being the mirror image thereof;
 FIG. 21 is a view in section taken along lines 21—21 in FIG. 17;
 FIG. 22 is a perspective view of a third modified embodiment of the design shown in FIGS. 1 through 7;
 FIG. 23 is a front elevational view;
 FIG. 24 is bottom plan view, partly broken away;
 FIG. 25 is a rear elevational view;
 FIG. 26 is top plan view;
 FIG. 27 is a right side elevational view, the left side being the mirror image thereof;
 FIG. 28 is a view in section taken along lines 27—27 in FIG. 24;
 FIG. 29 is a perspective view of a fourth modified embodiment of the design shown in FIGS. 1 through 7;
 FIG. 30 is a front elevational view;
 FIG. 31 is bottom plan view, partly broken away;
 FIG. 32 is rear elevational view;
 FIG. 33 is top plan view;
 FIG. 34 is a right side elevational view, the left side being the mirror image thereof;
 FIG. 35 is a view in section taken along lines 35—35 in FIG. 31;
 FIG. 36 is a perspective view of a fifth modified embodiment of the design shown in FIGS. 1 through 7;
 FIG. 37 is a front elevational view;
 FIG. 38 is bottom plan view, partly broken away;
 FIG. 39 is a rear elevational view;
 FIG. 40 is top plan view;
 FIG. 41 is a right side elevational view, the left side being the mirror image thereof;
 FIG. 42 is a view in section taken along lines 42—42 in FIG. 38.

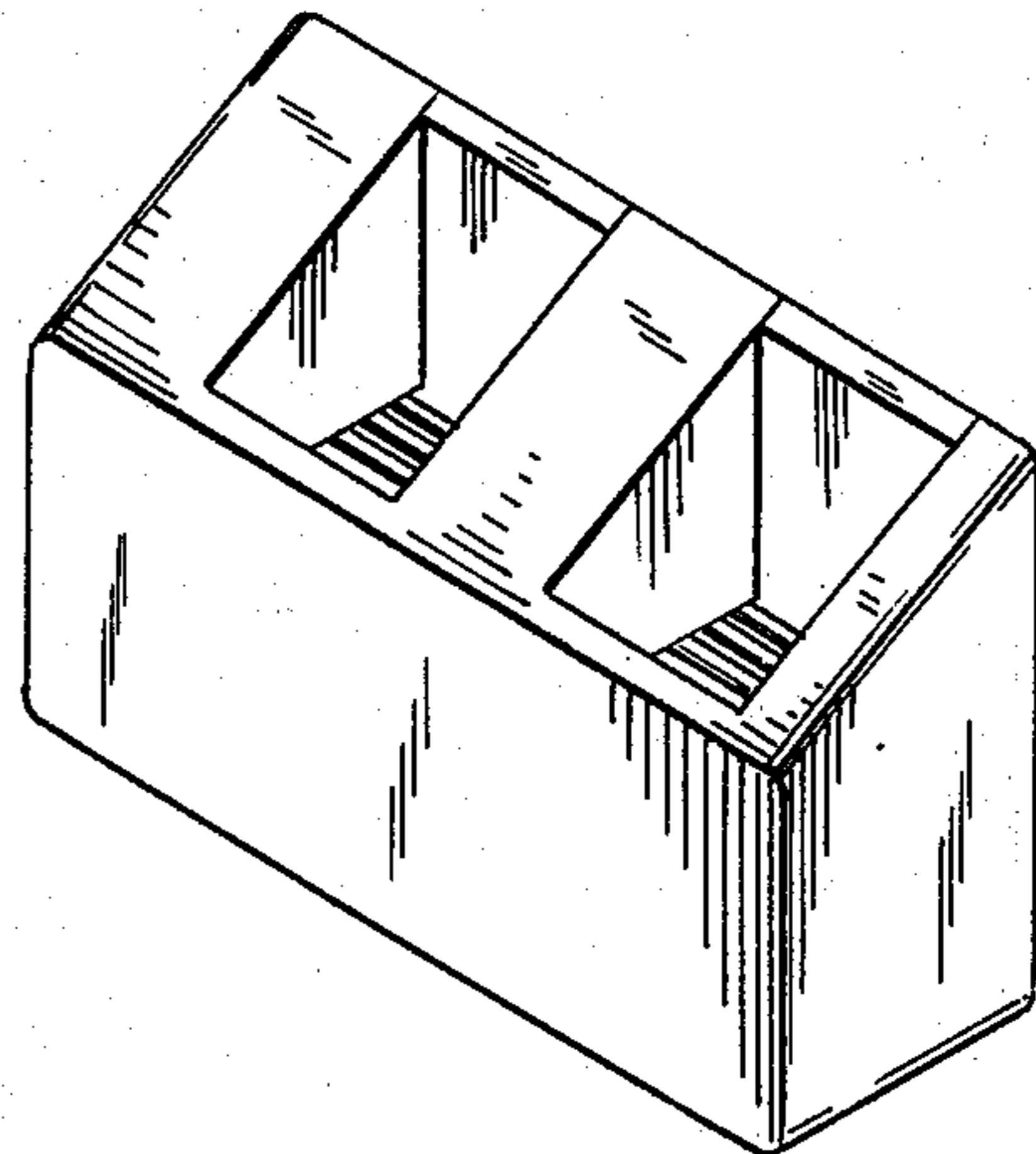
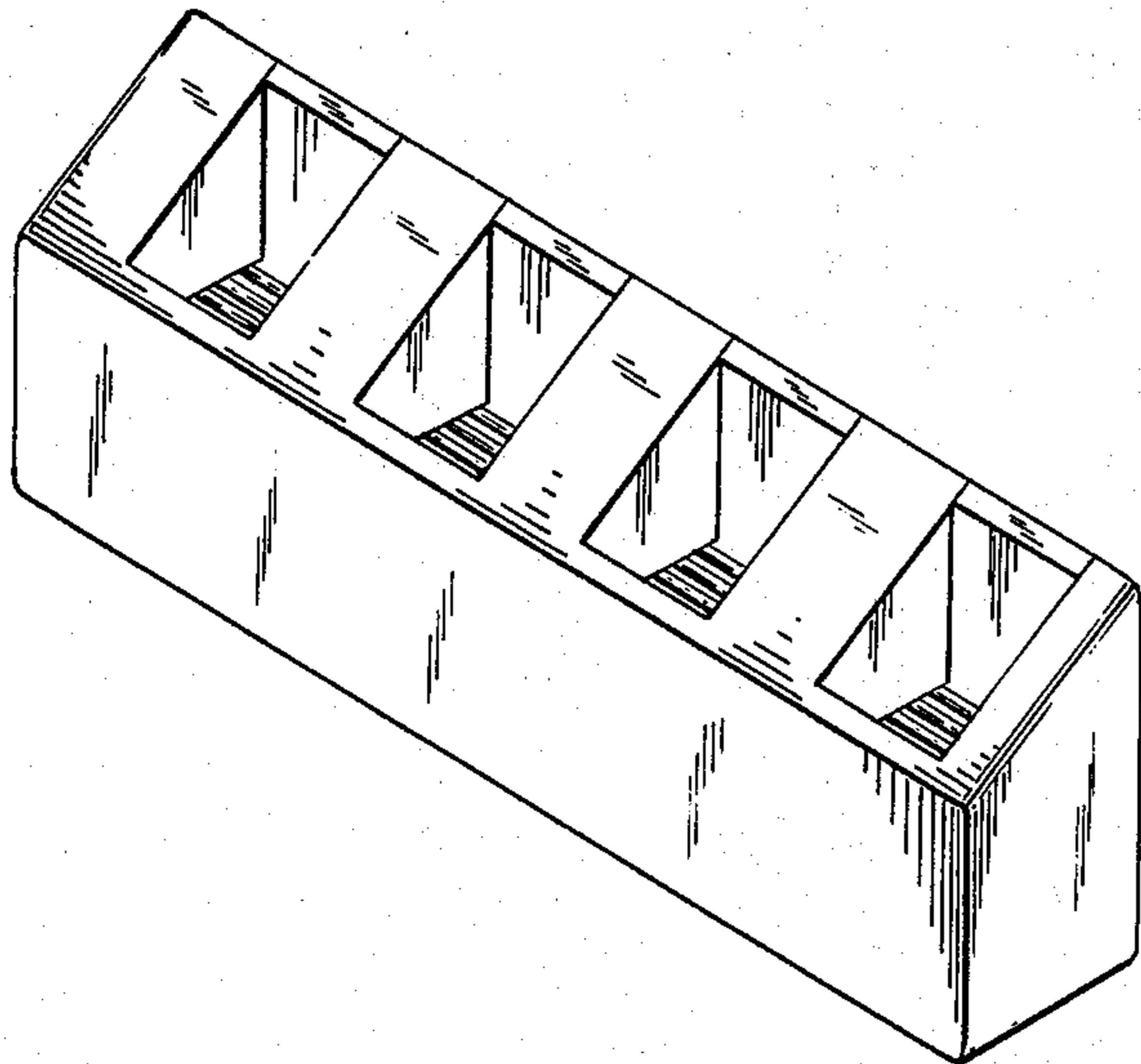

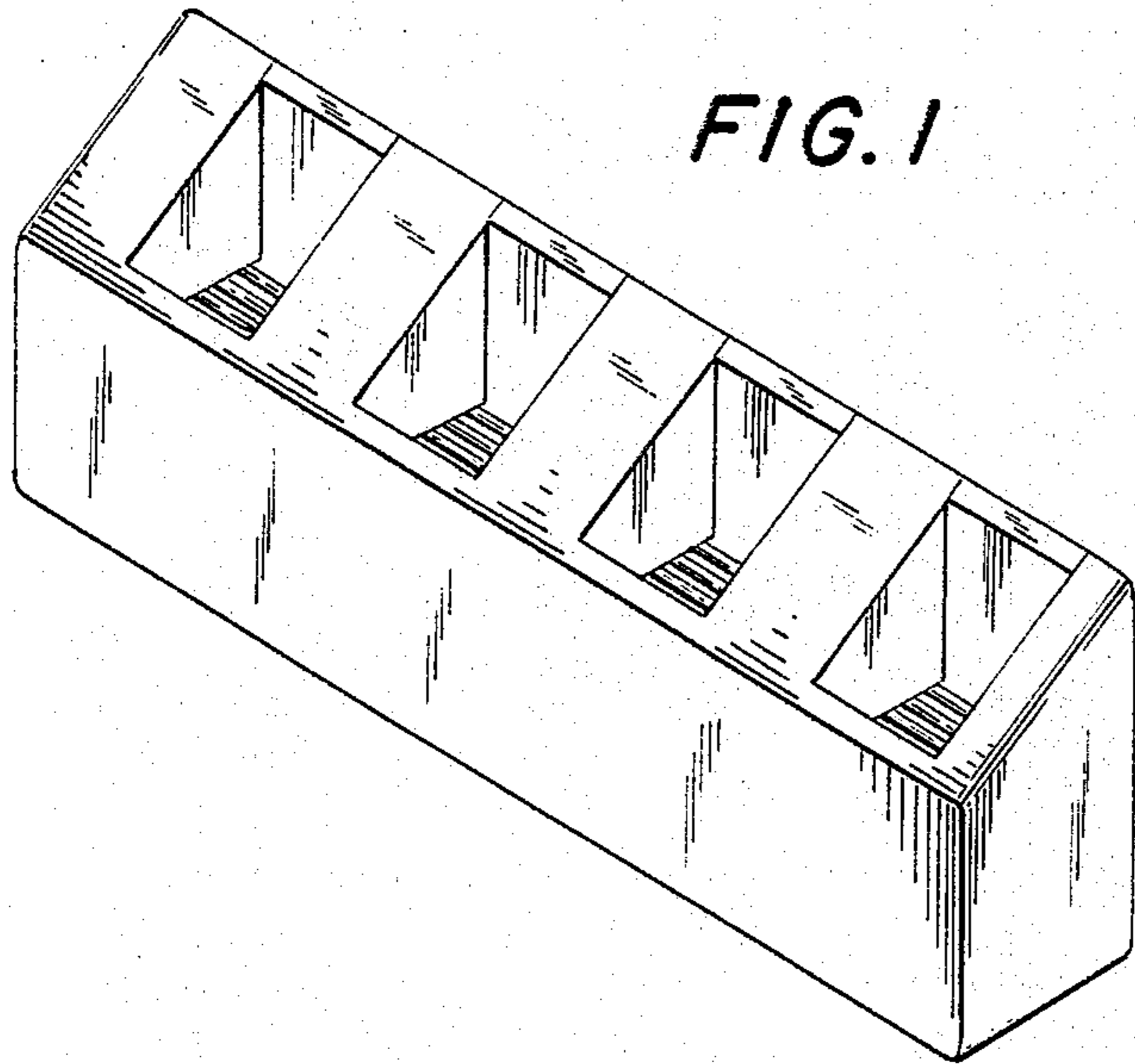

FIG. 1

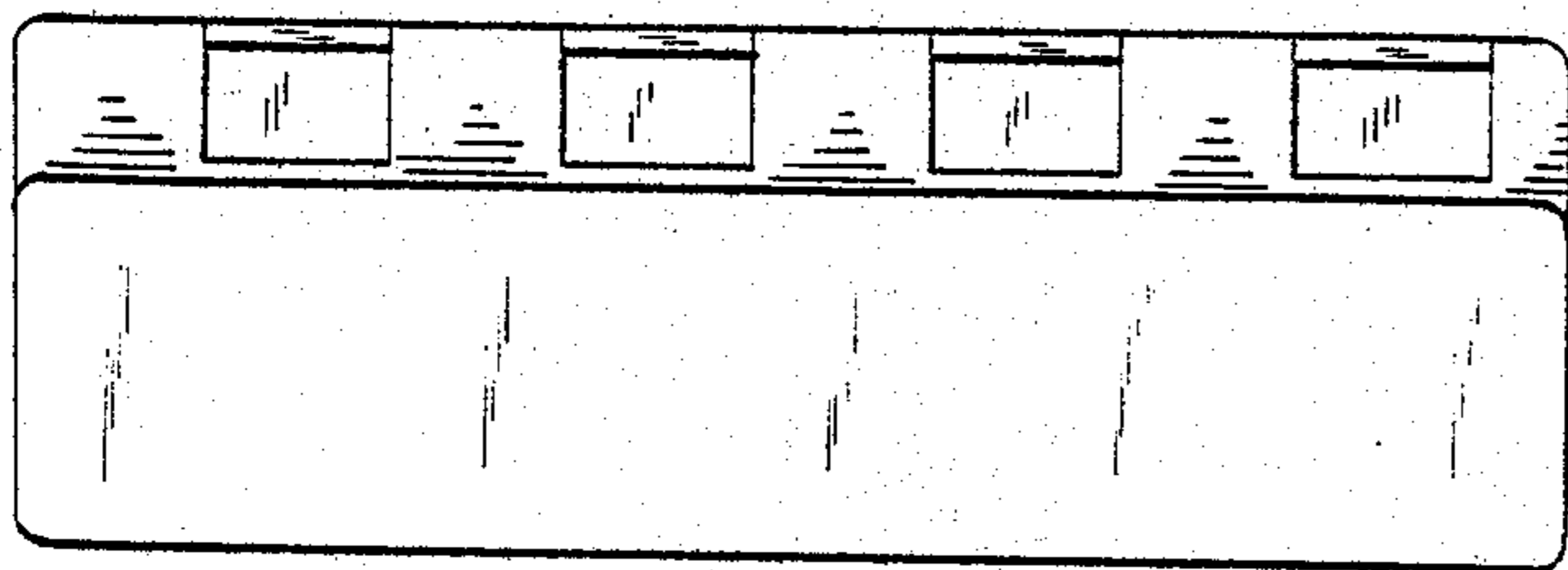

FIG. 2

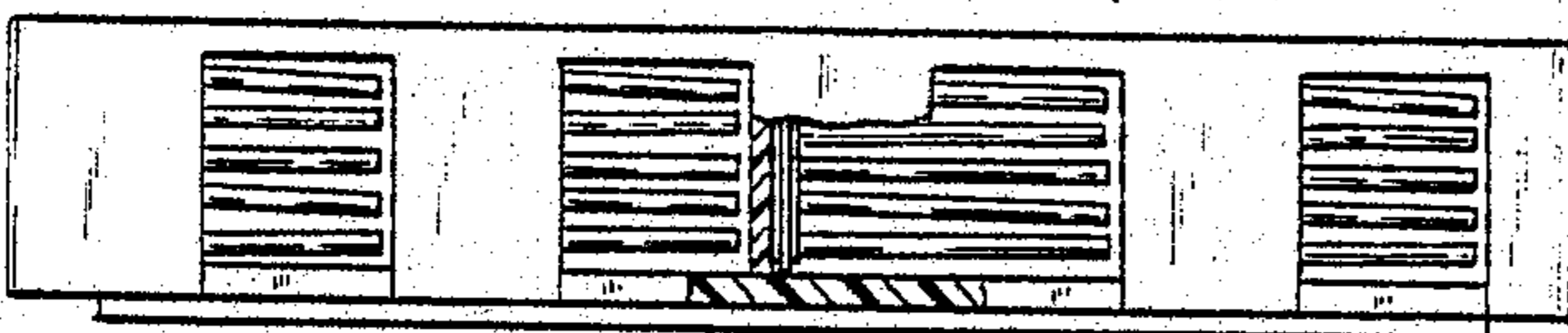

FIG. 3

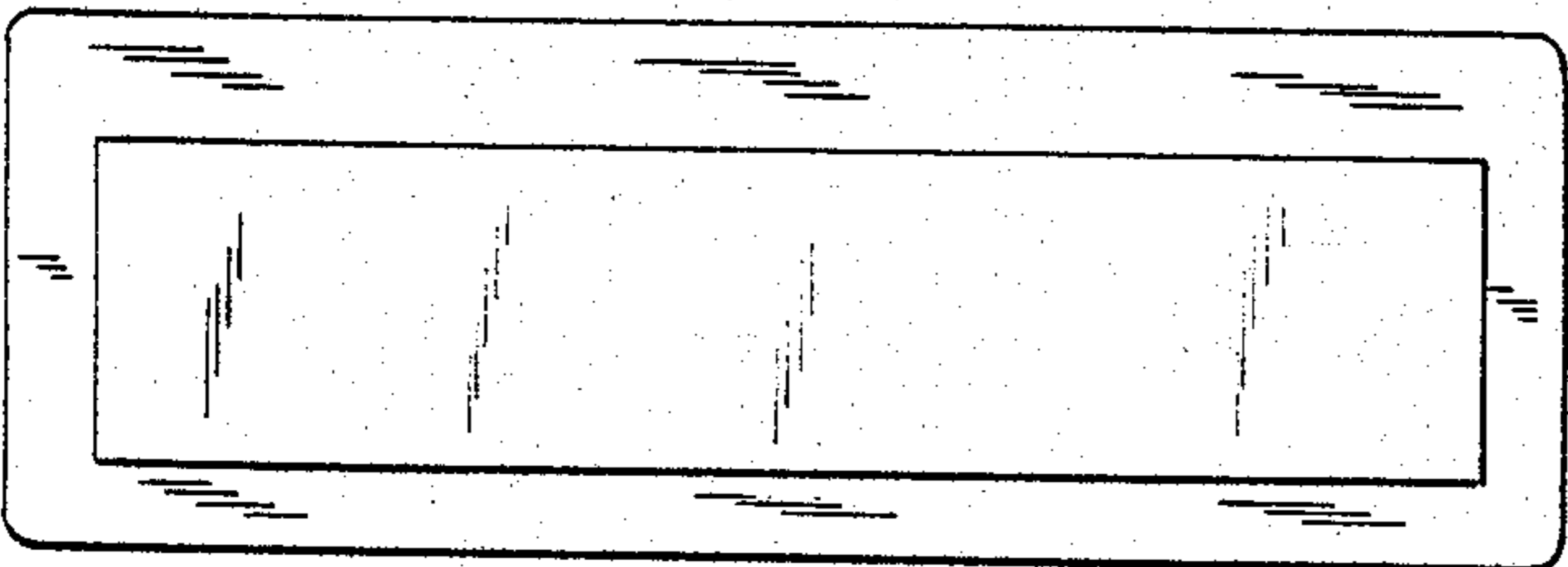

FIG. 4

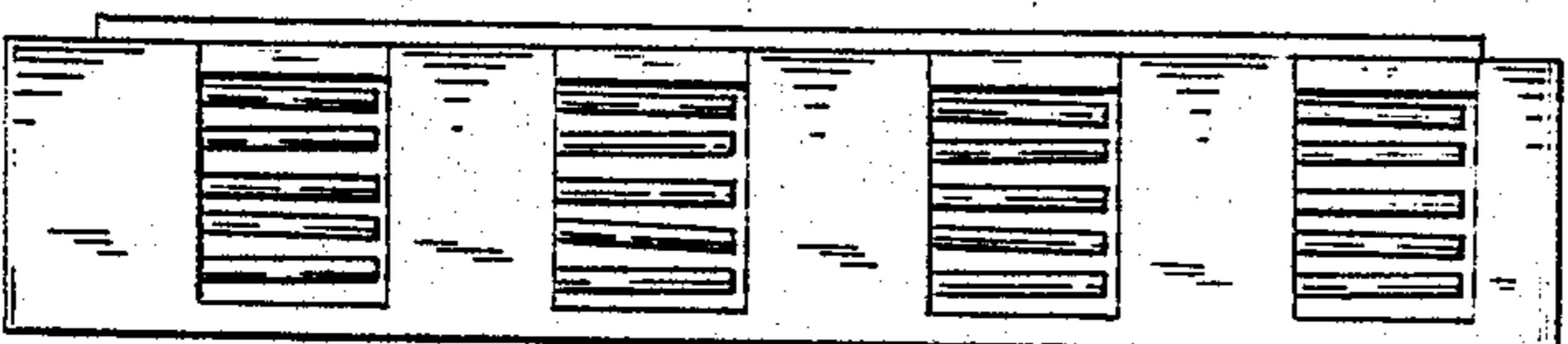

FIG. 5

FIG. 6

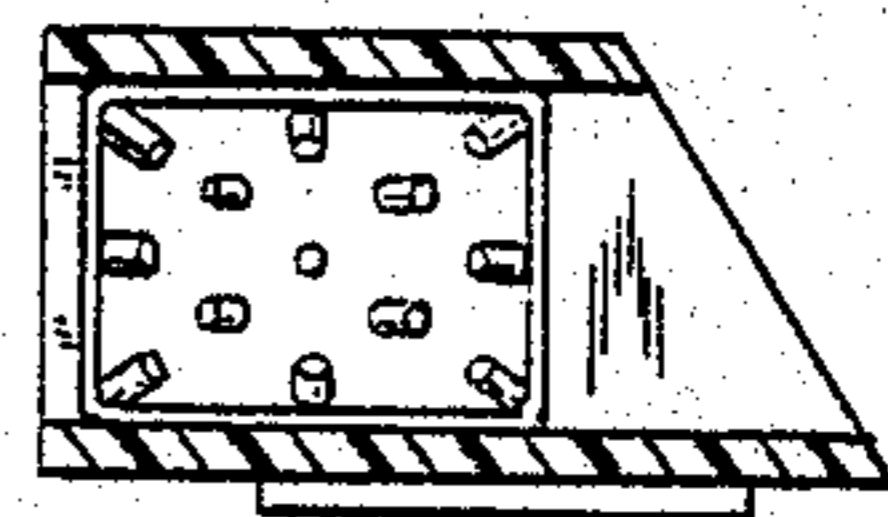
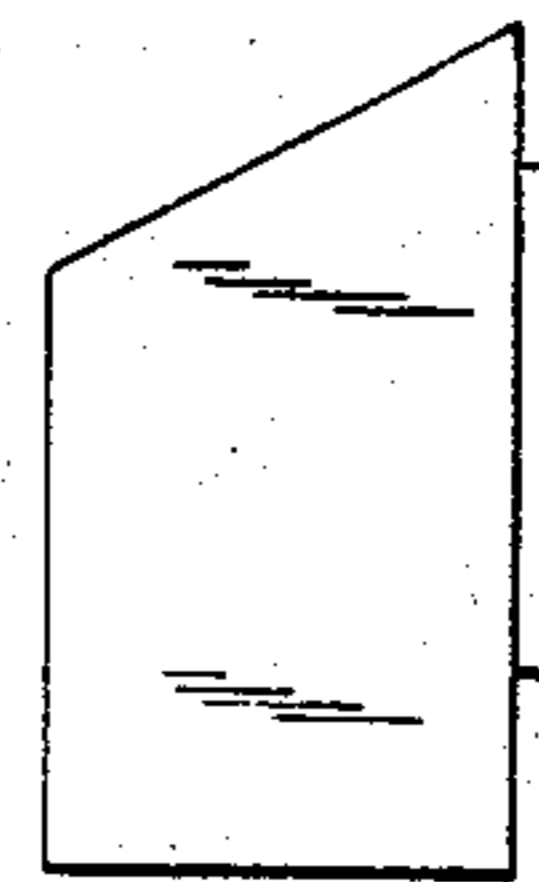

FIG. 7

FIG. 8

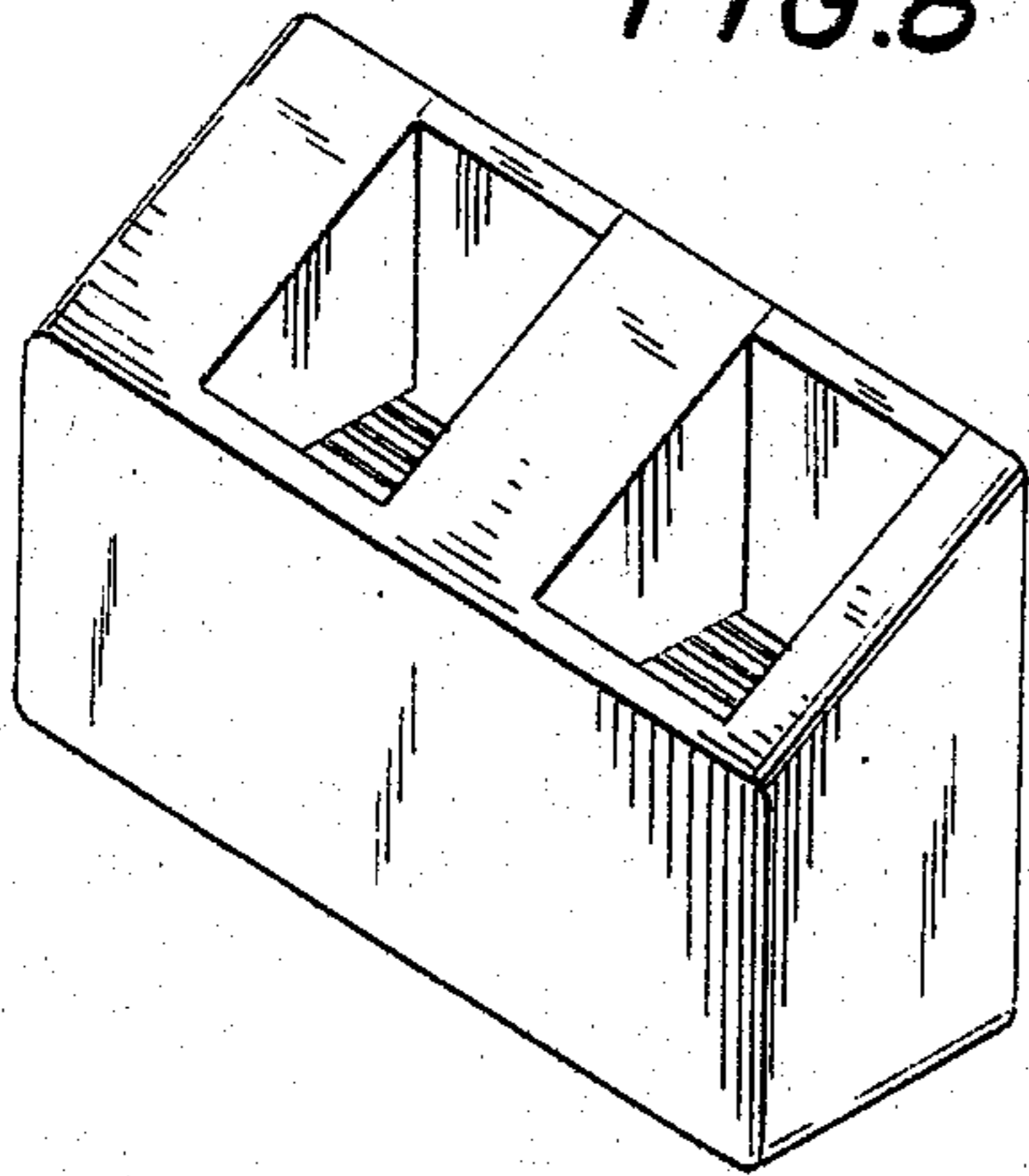

FIG. 9

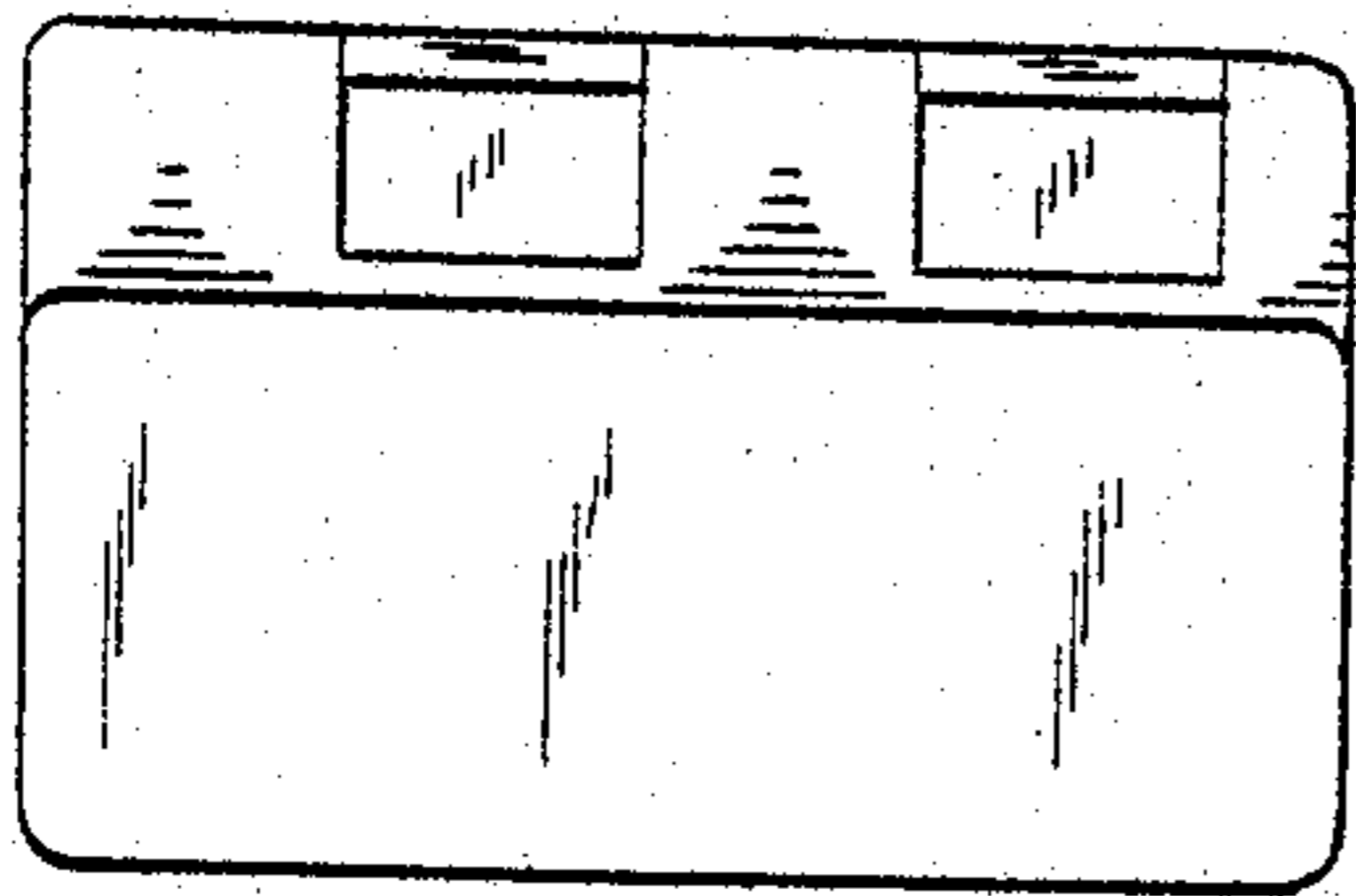

FIG. 13

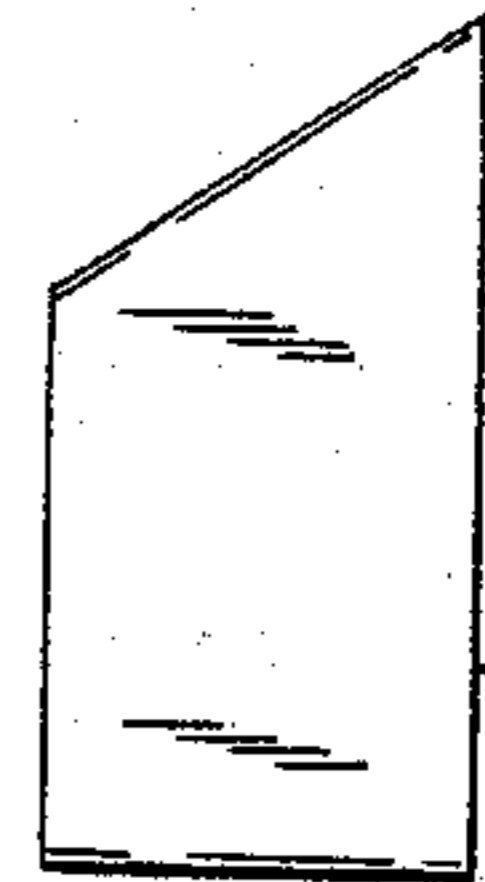

FIG. 10

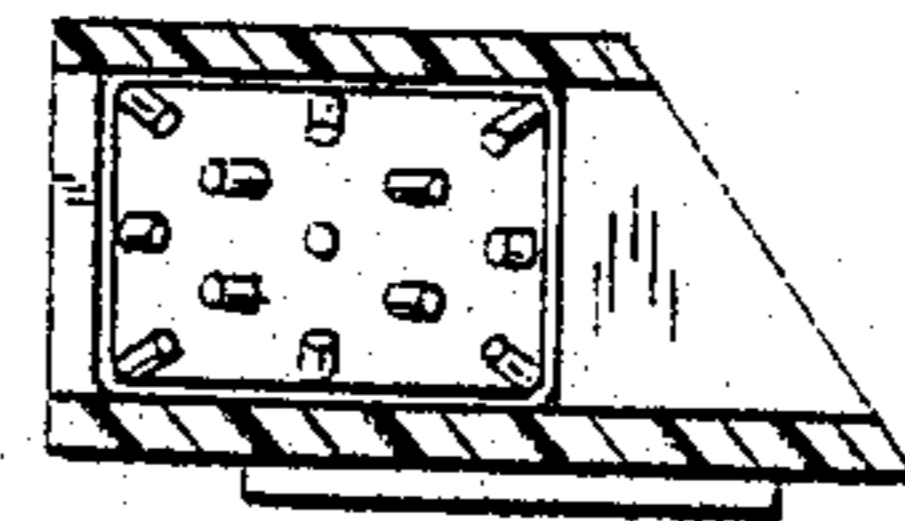
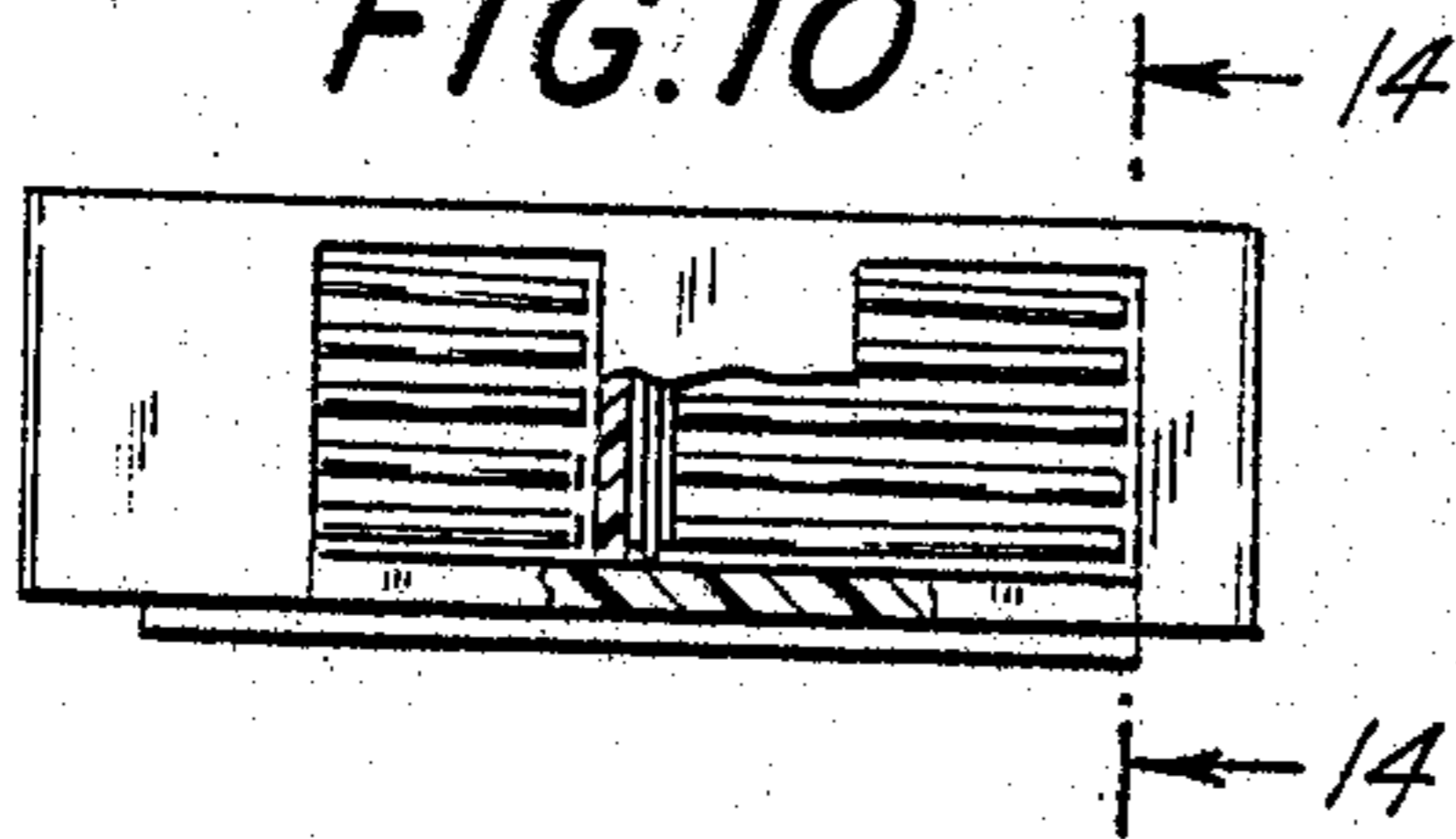

FIG. 14

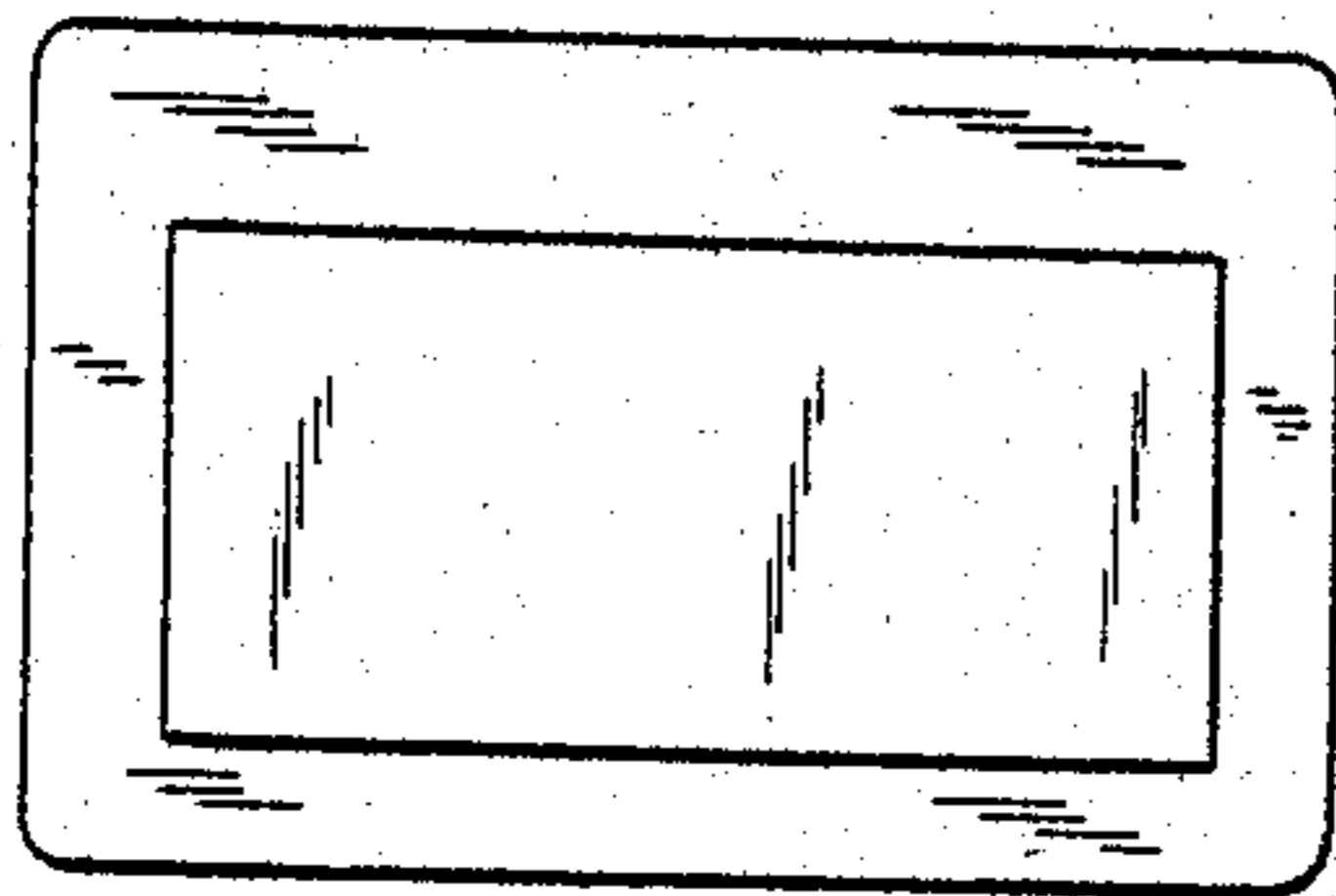

FIG. 11

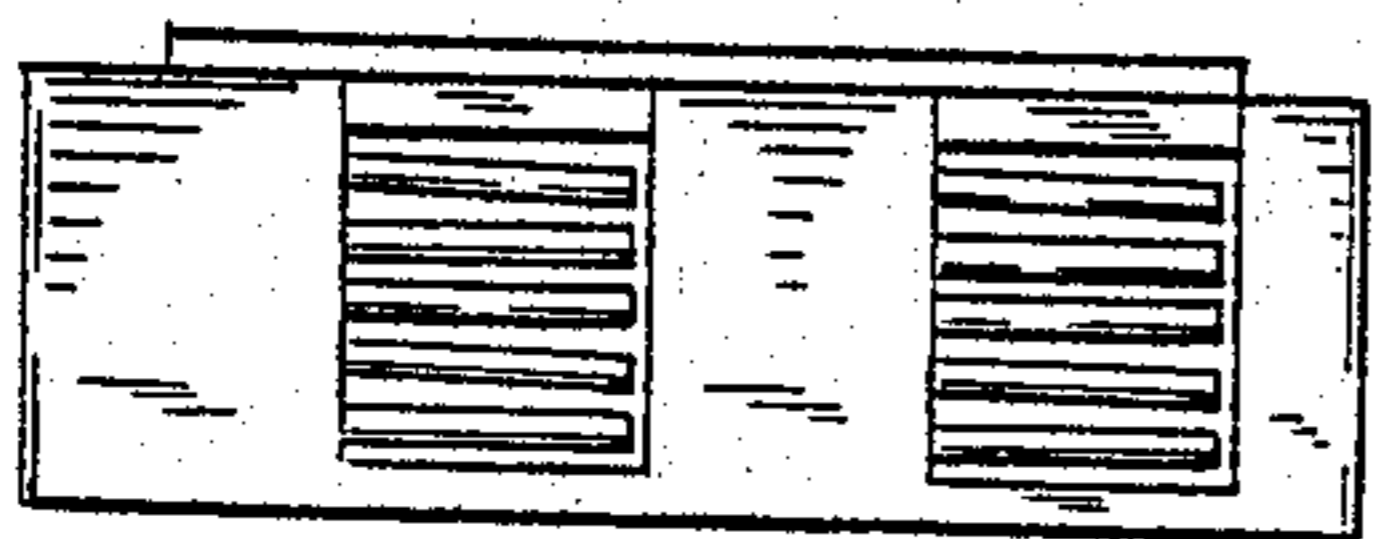

FIG. 12

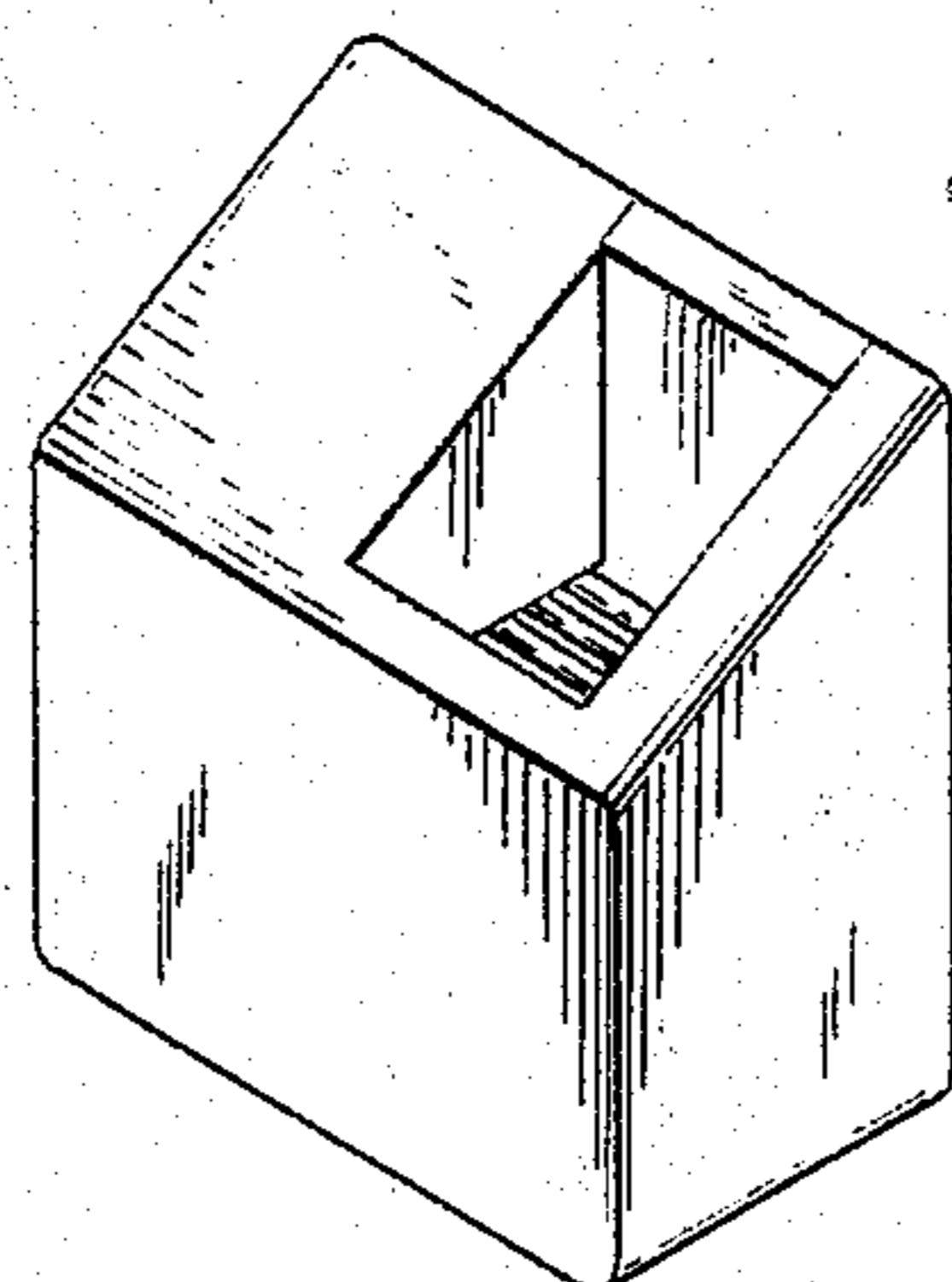

FIG. 15

FIG. 16

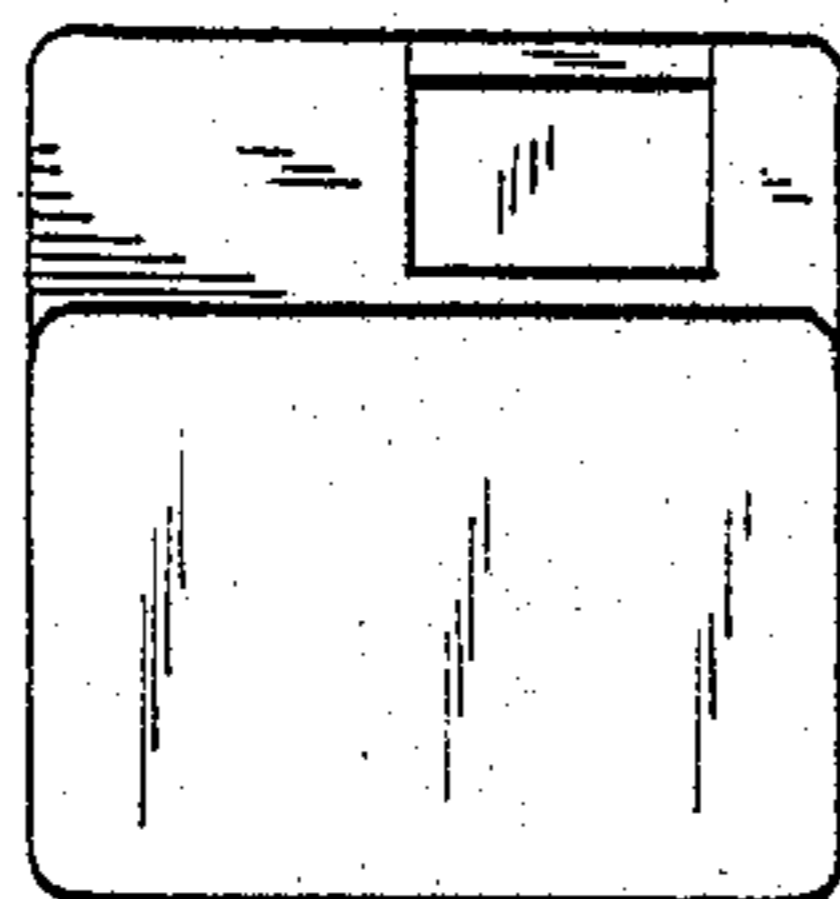

FIG. 20

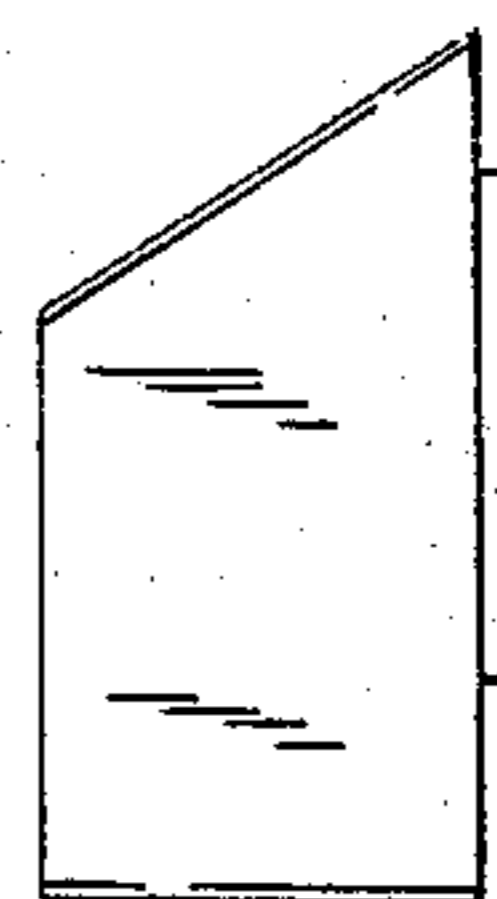

FIG. 17

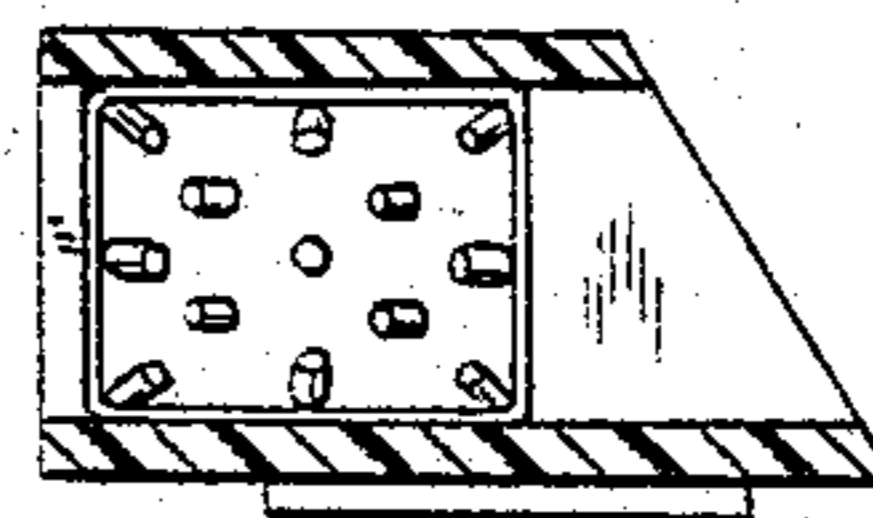
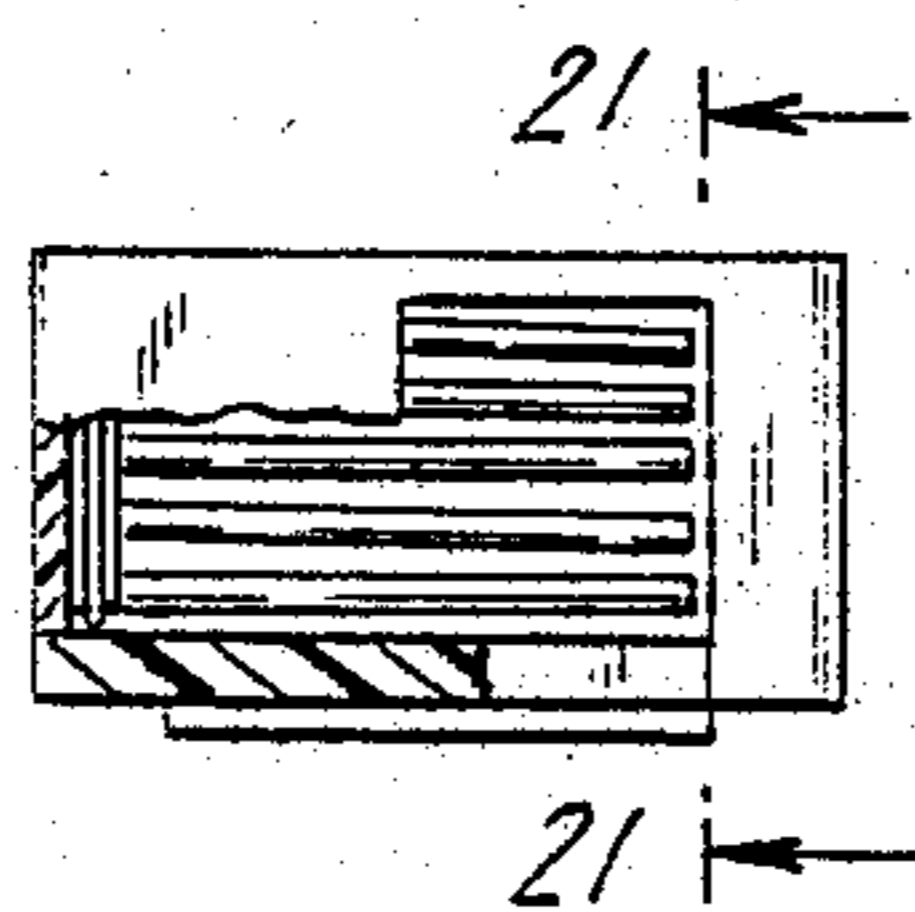

FIG. 21

FIG. 18

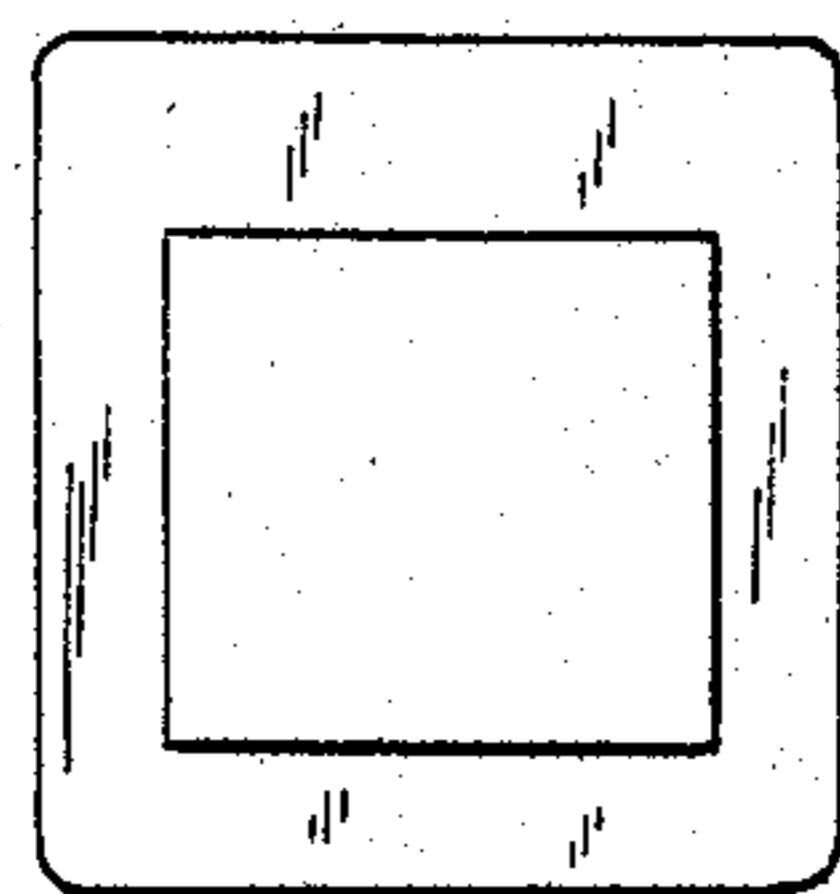
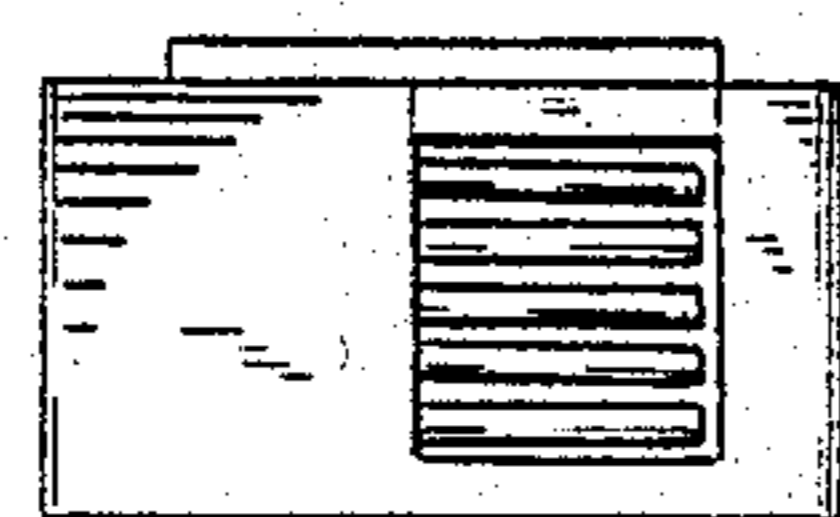

FIG. 19



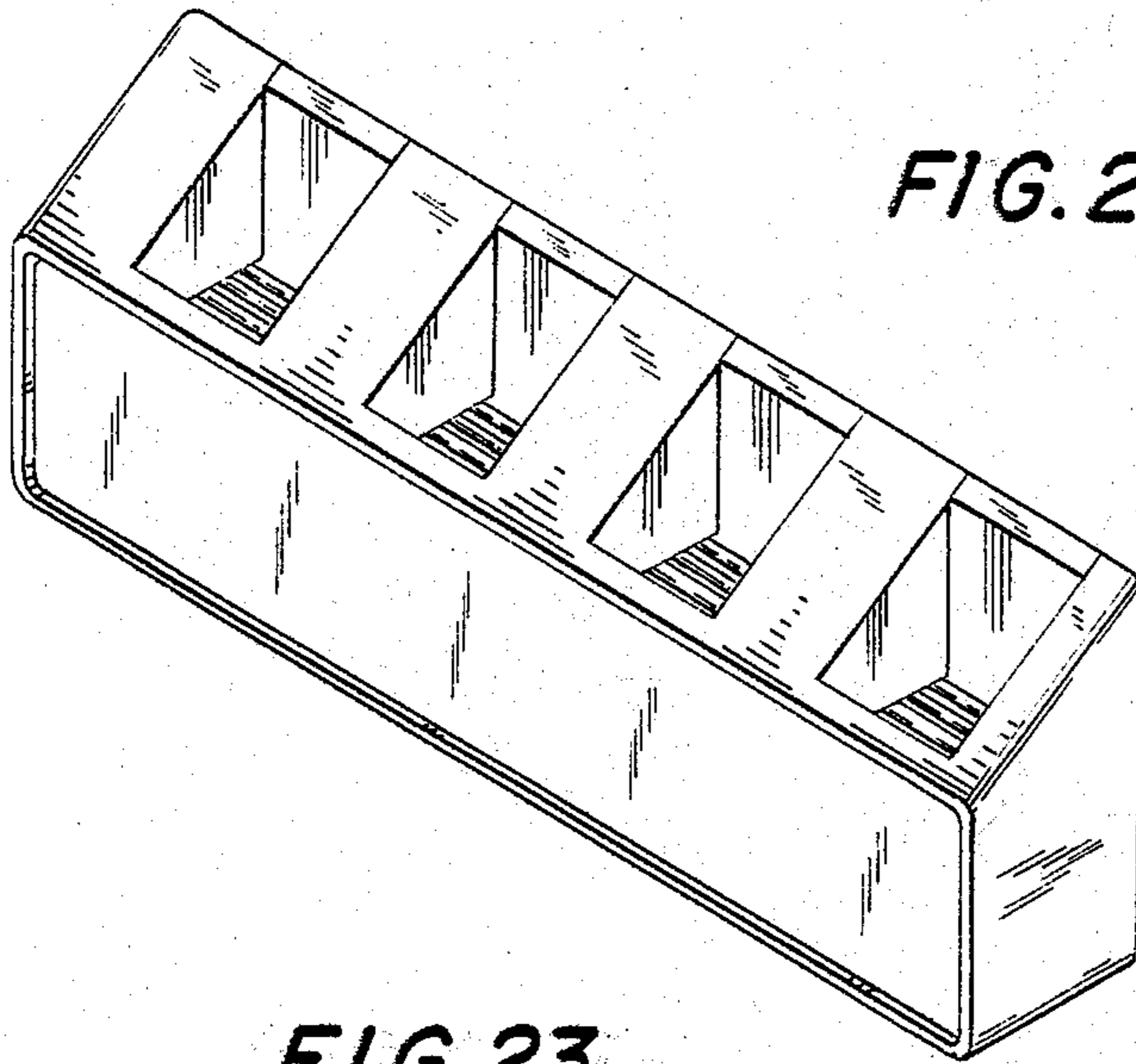

FIG. 22

FIG. 23

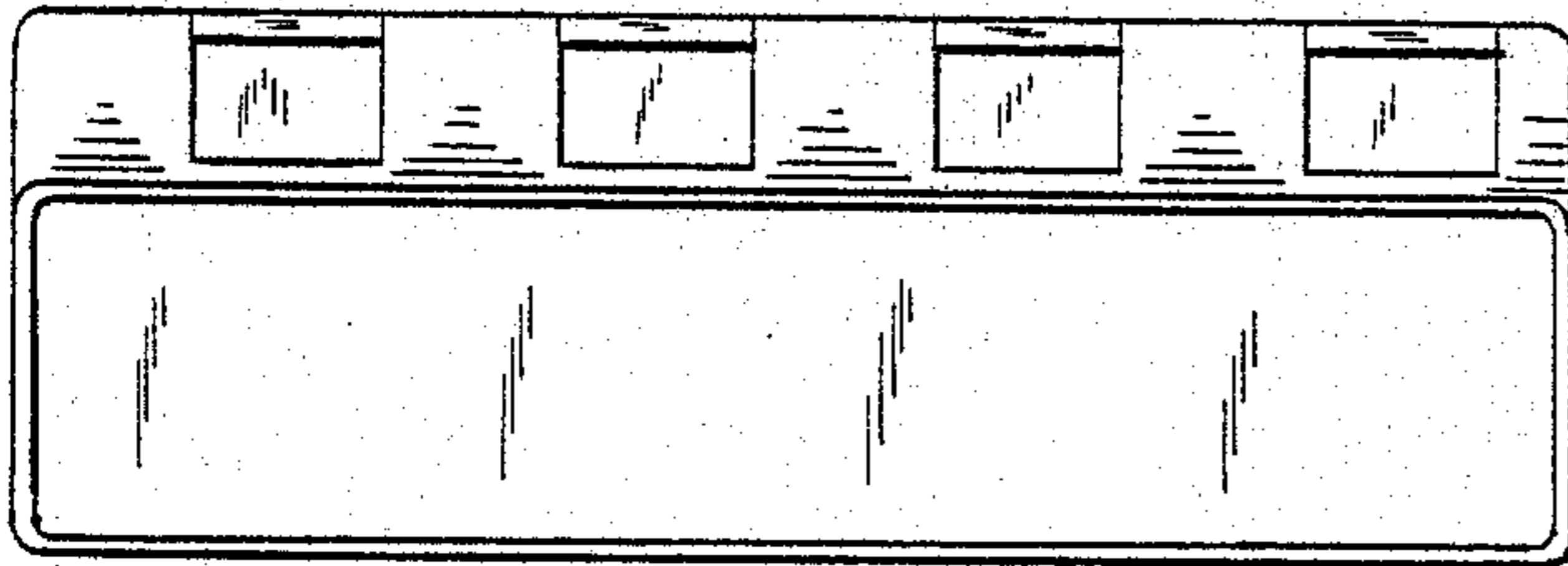

FIG. 27

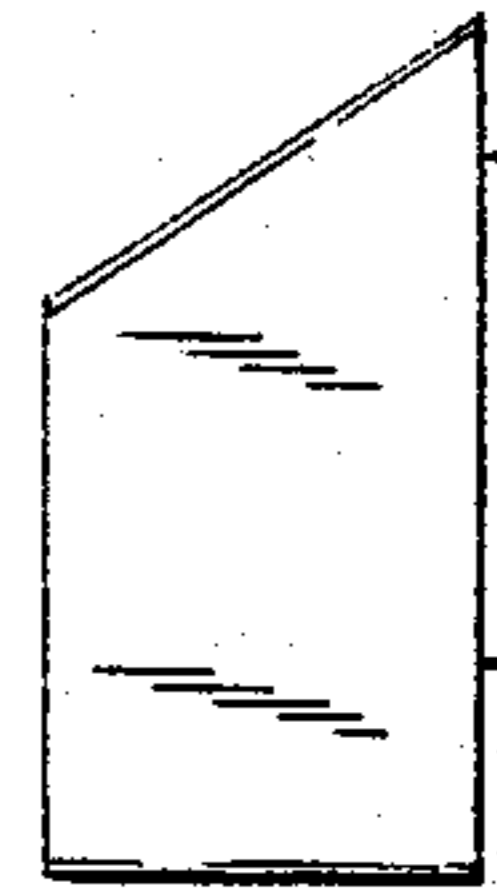

FIG. 24

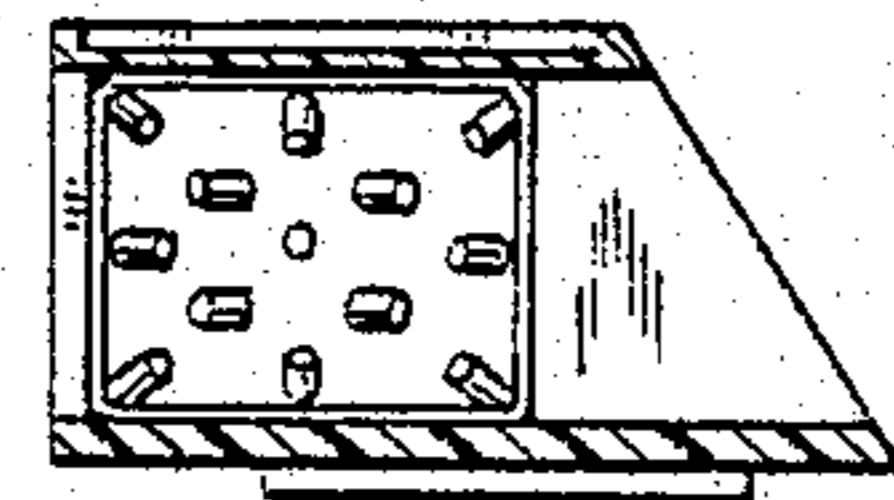
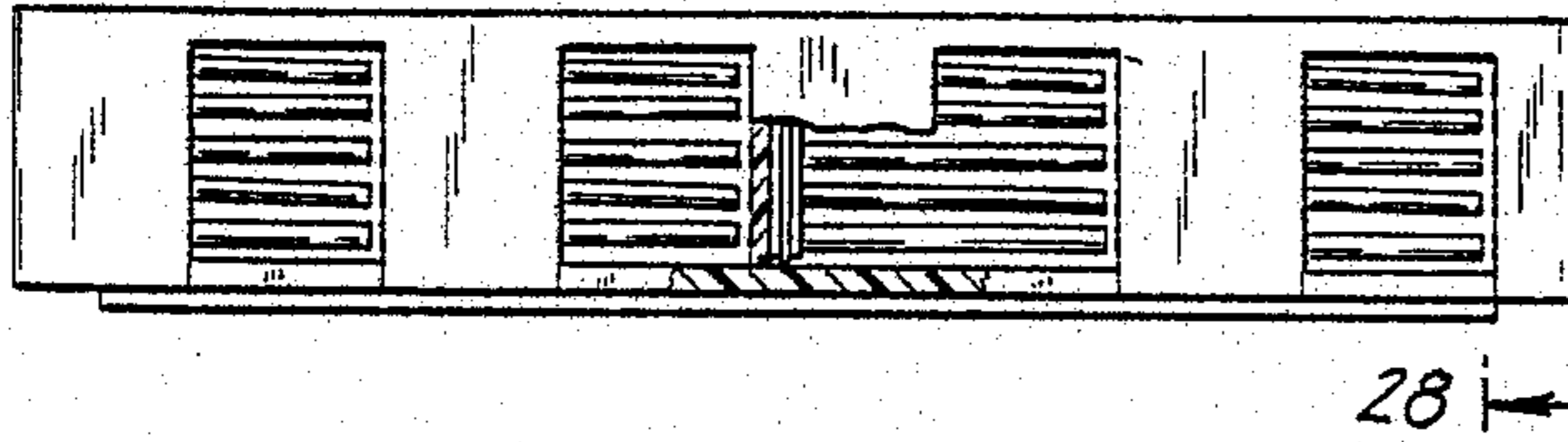

FIG. 28

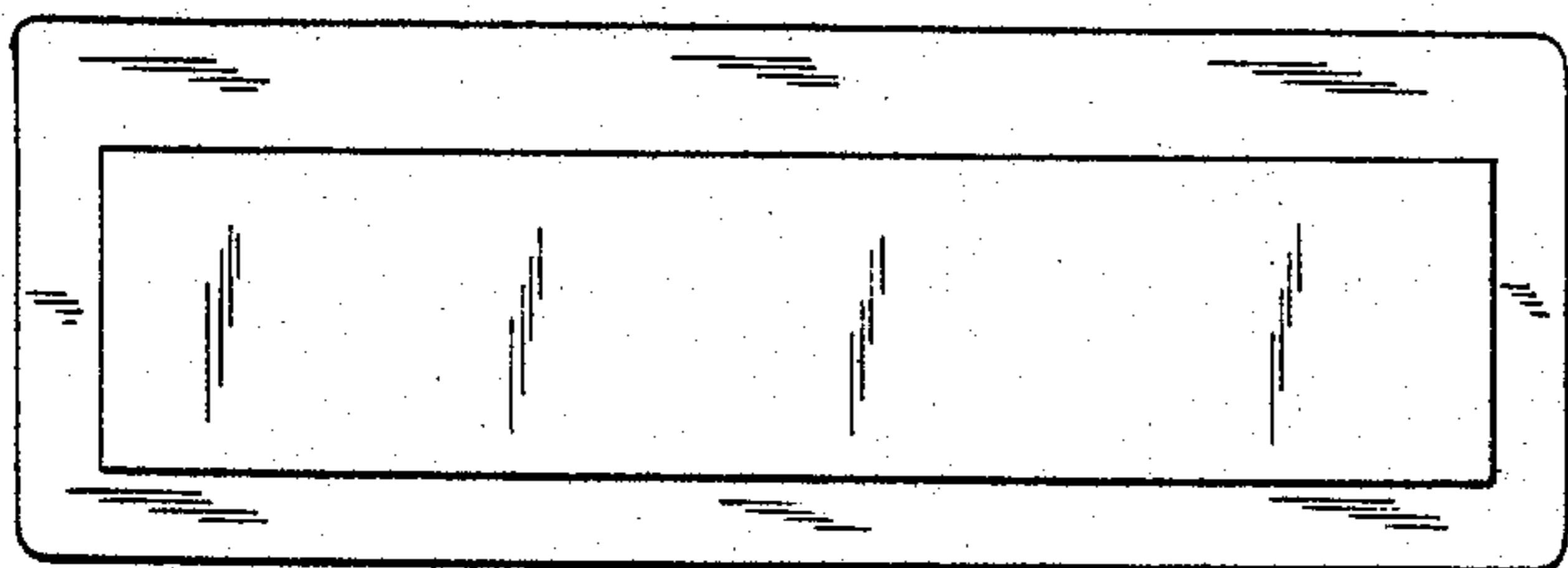

FIG. 25

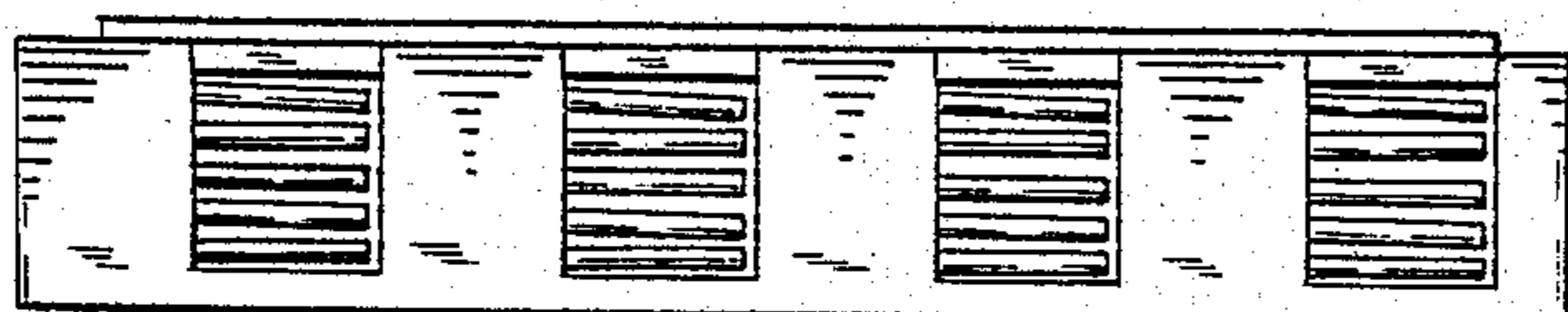

FIG. 26

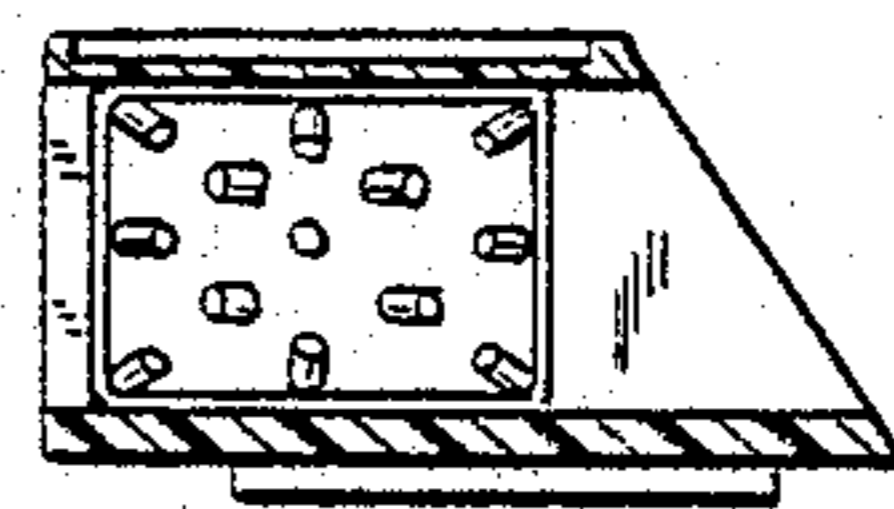
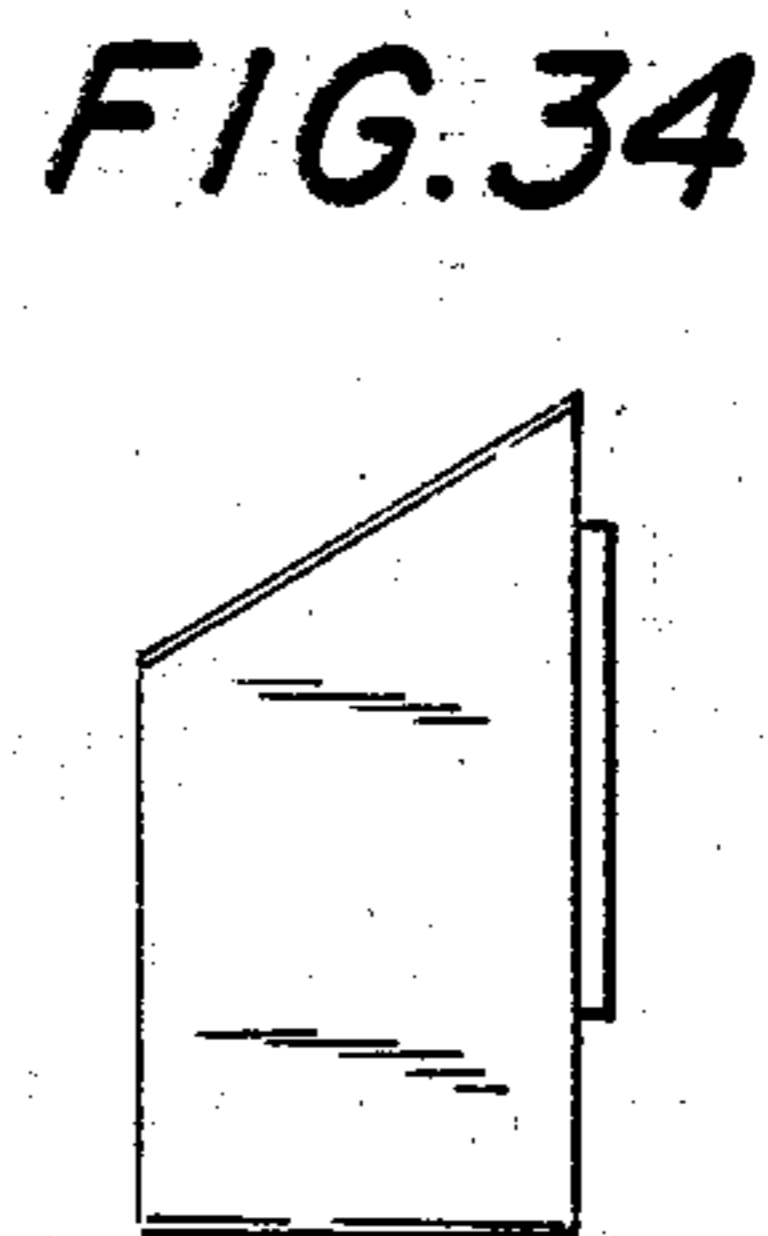
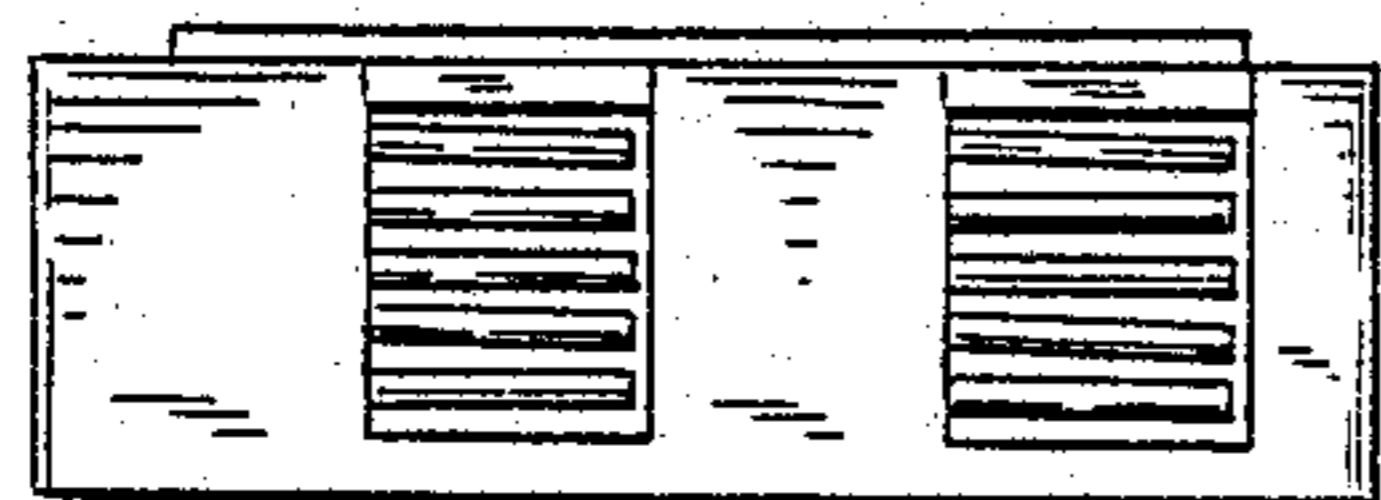
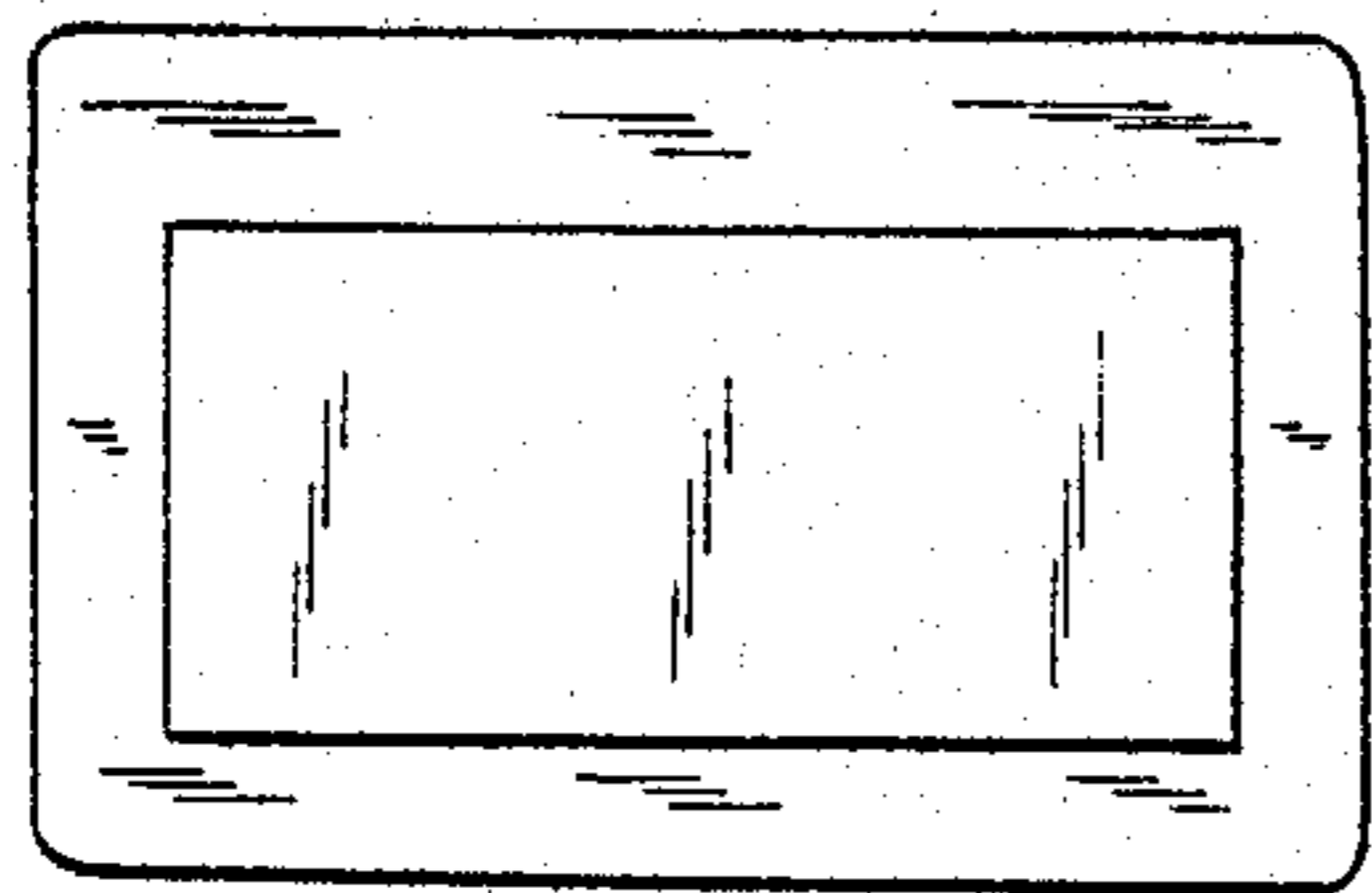
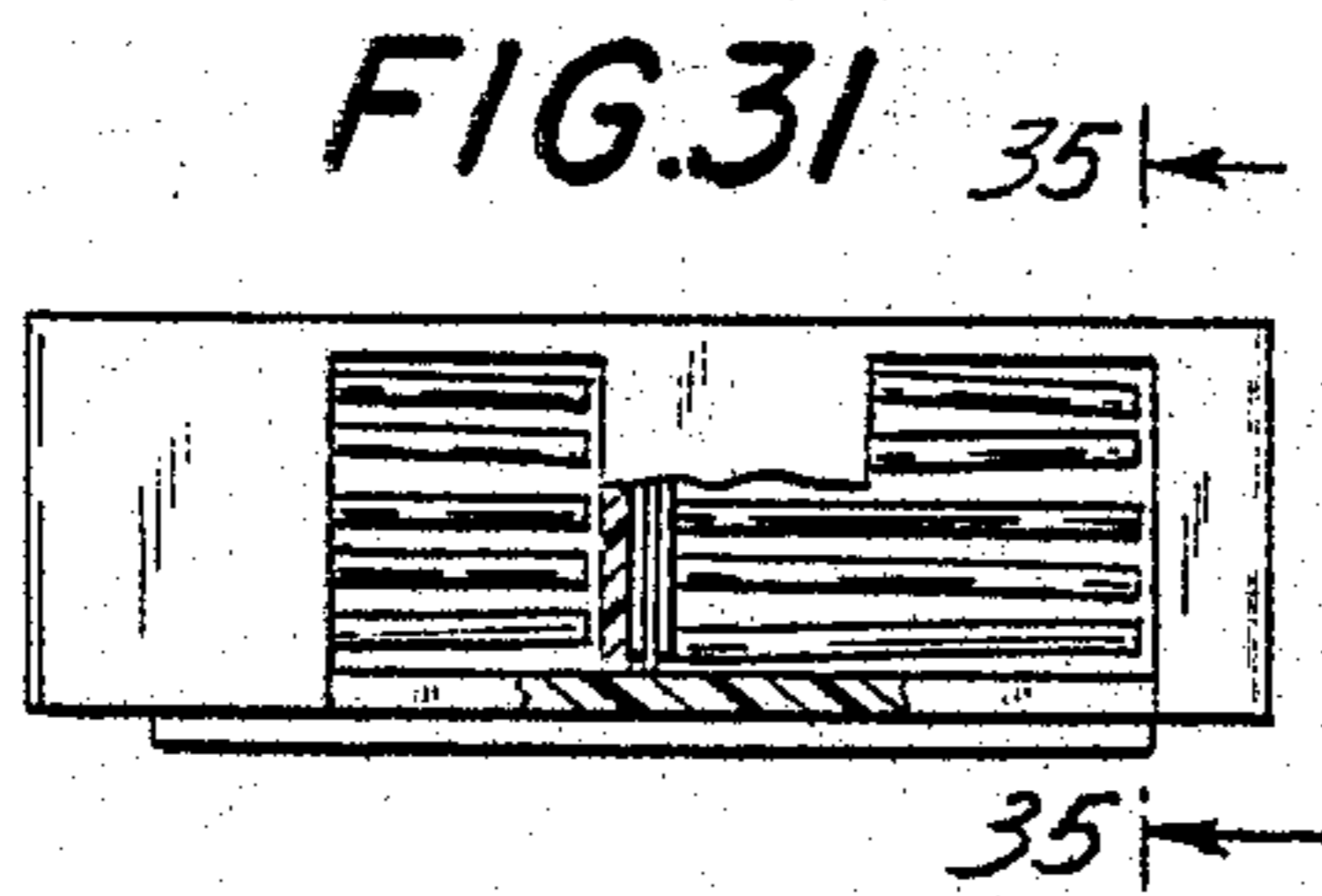
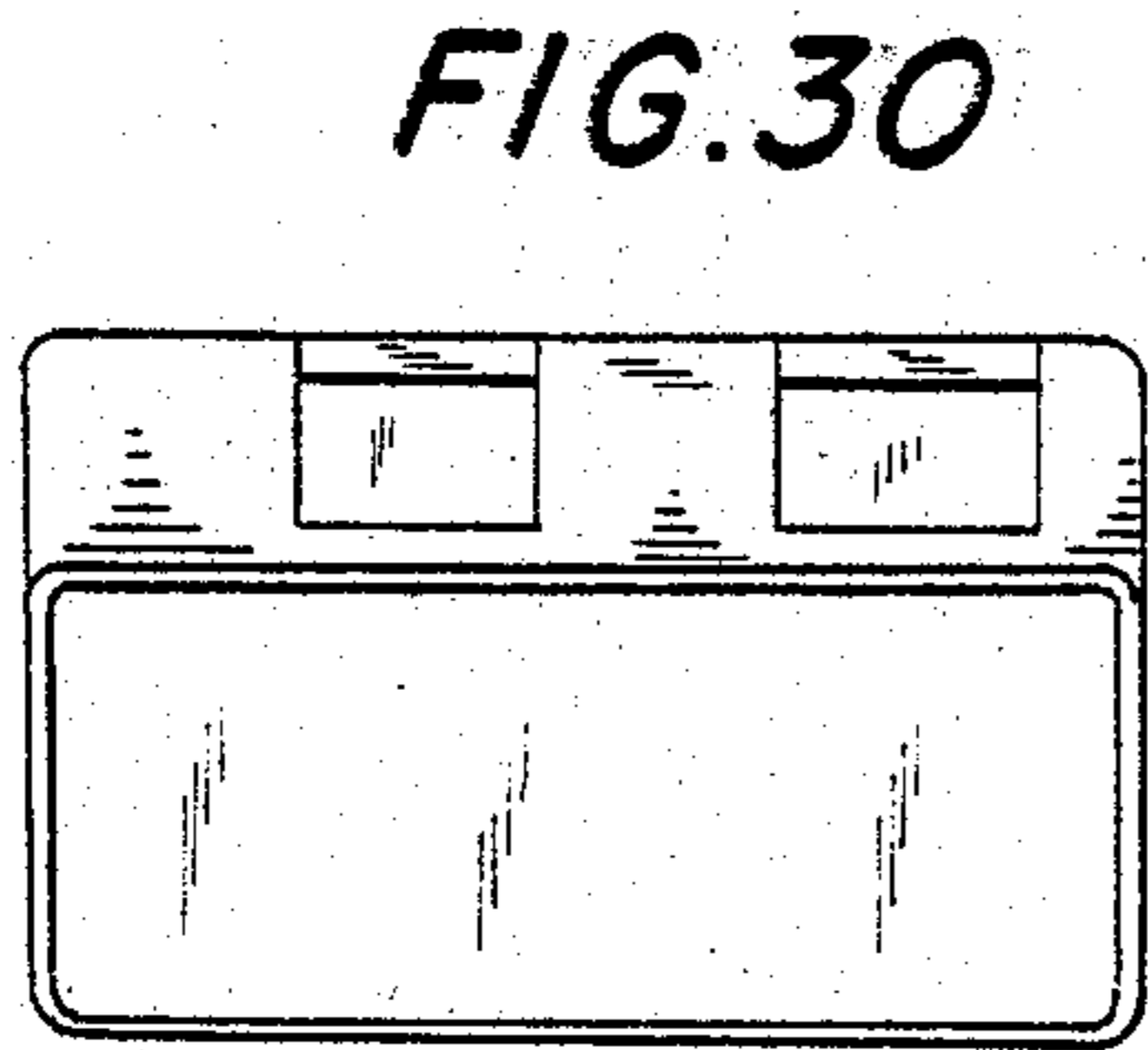
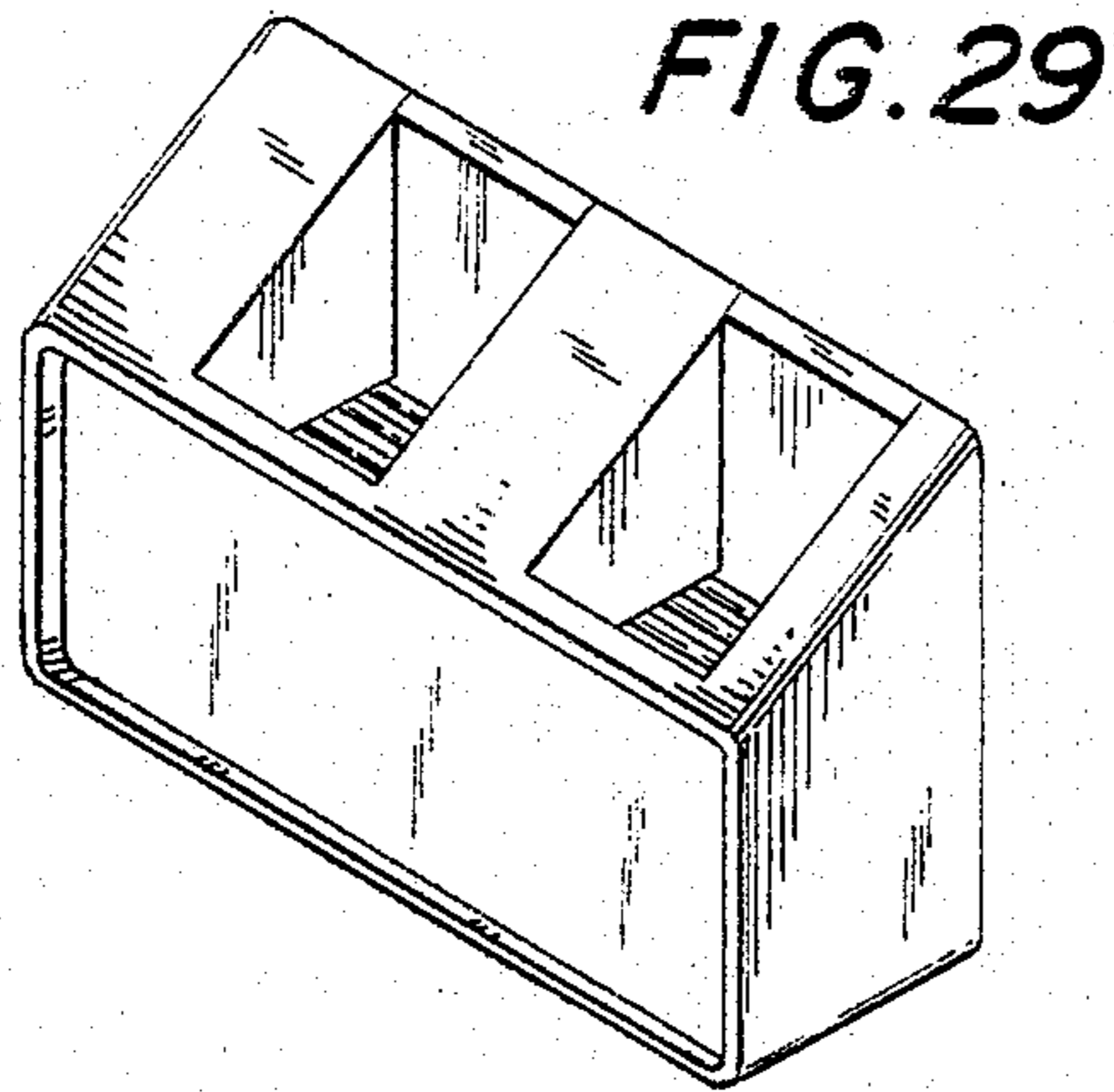

FIG. 35

FIG. 32

FIG. 33

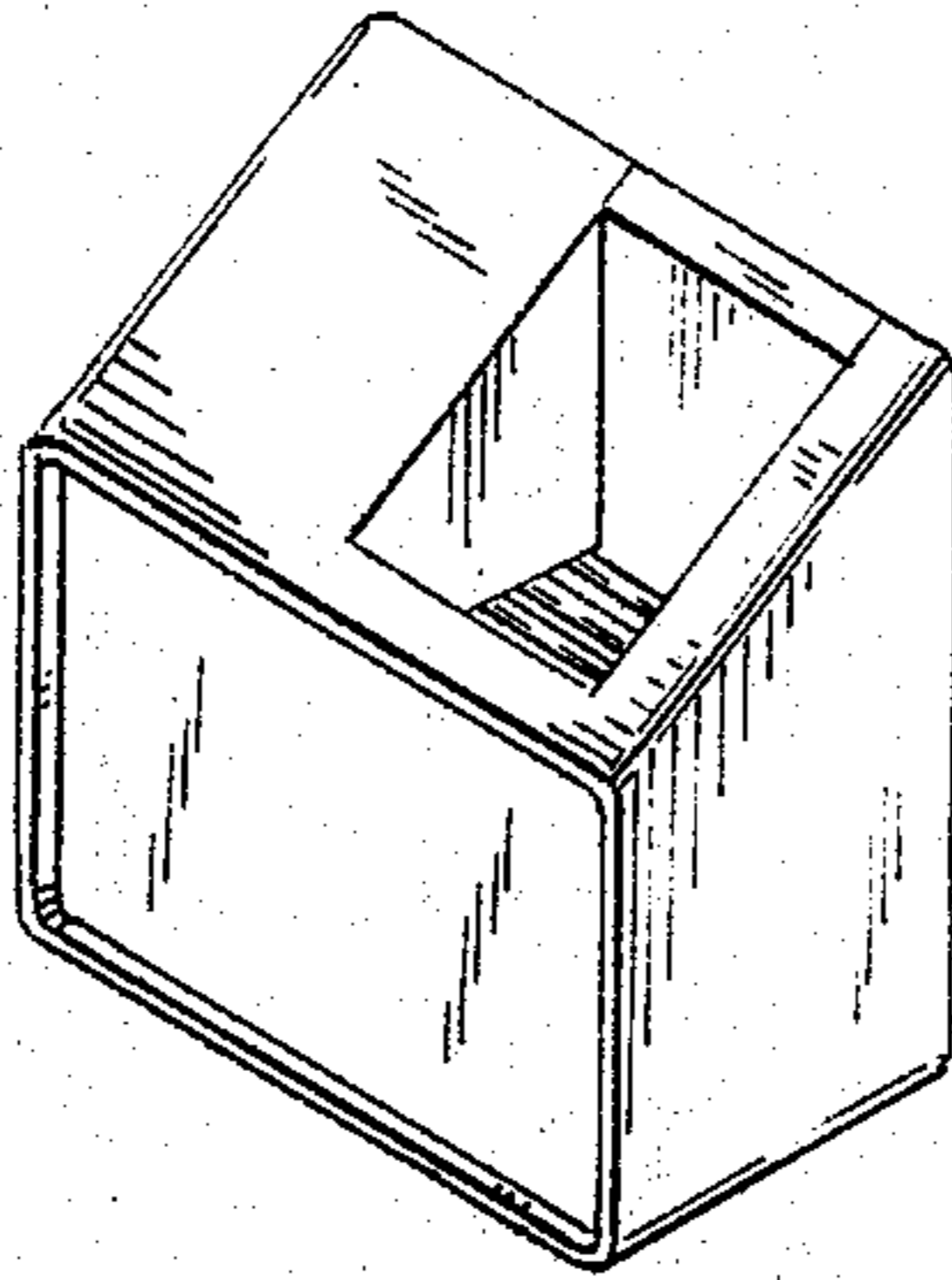

FIG. 36

FIG. 37

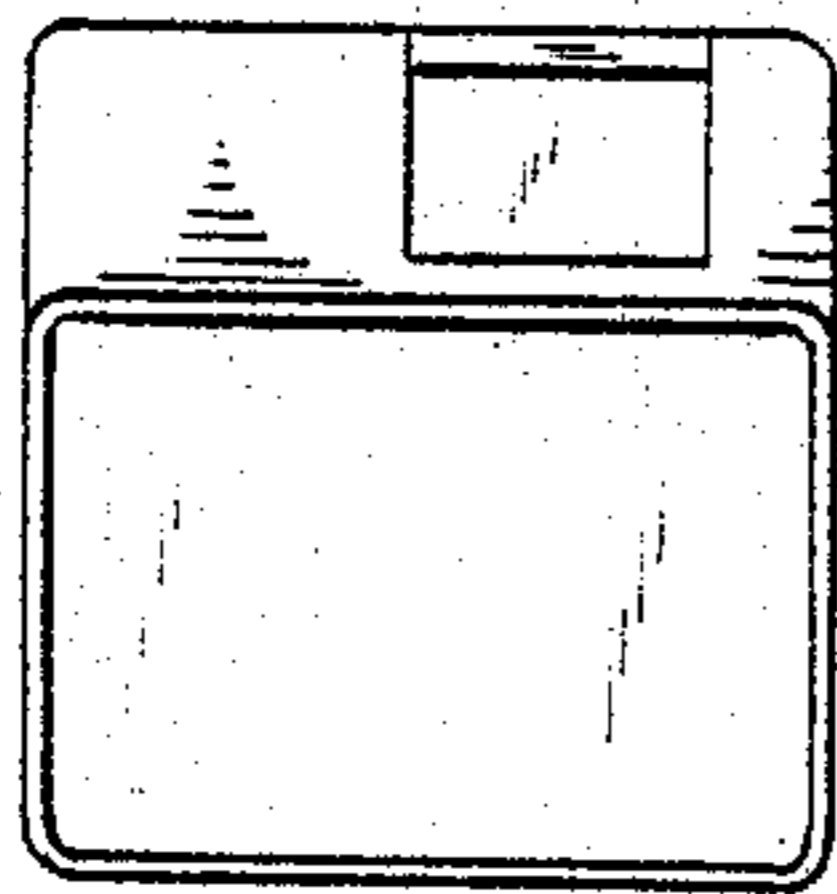

FIG. 41

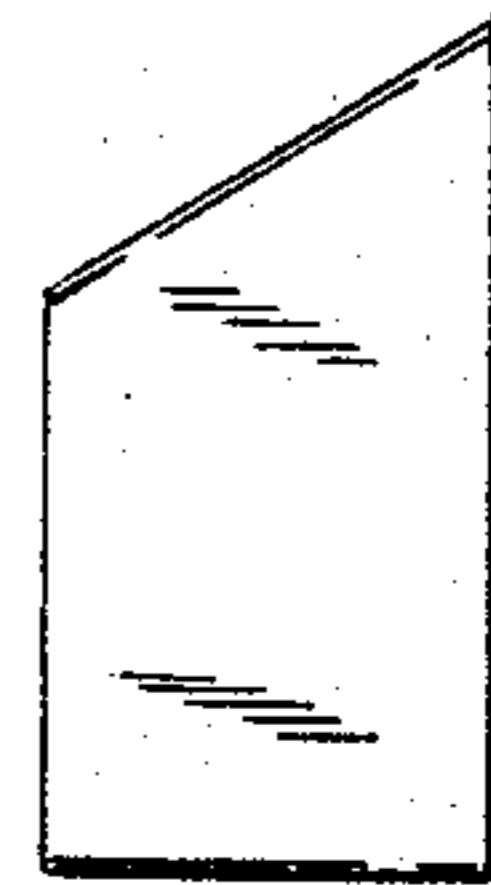

FIG. 38

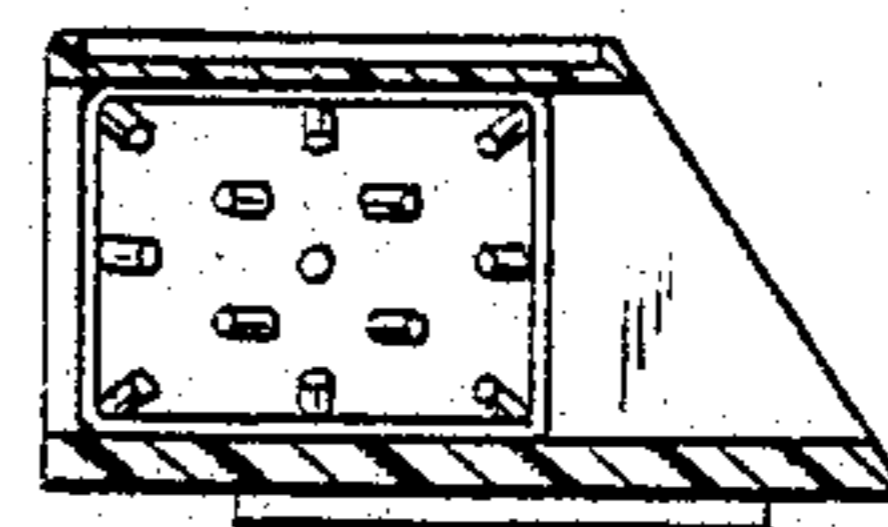
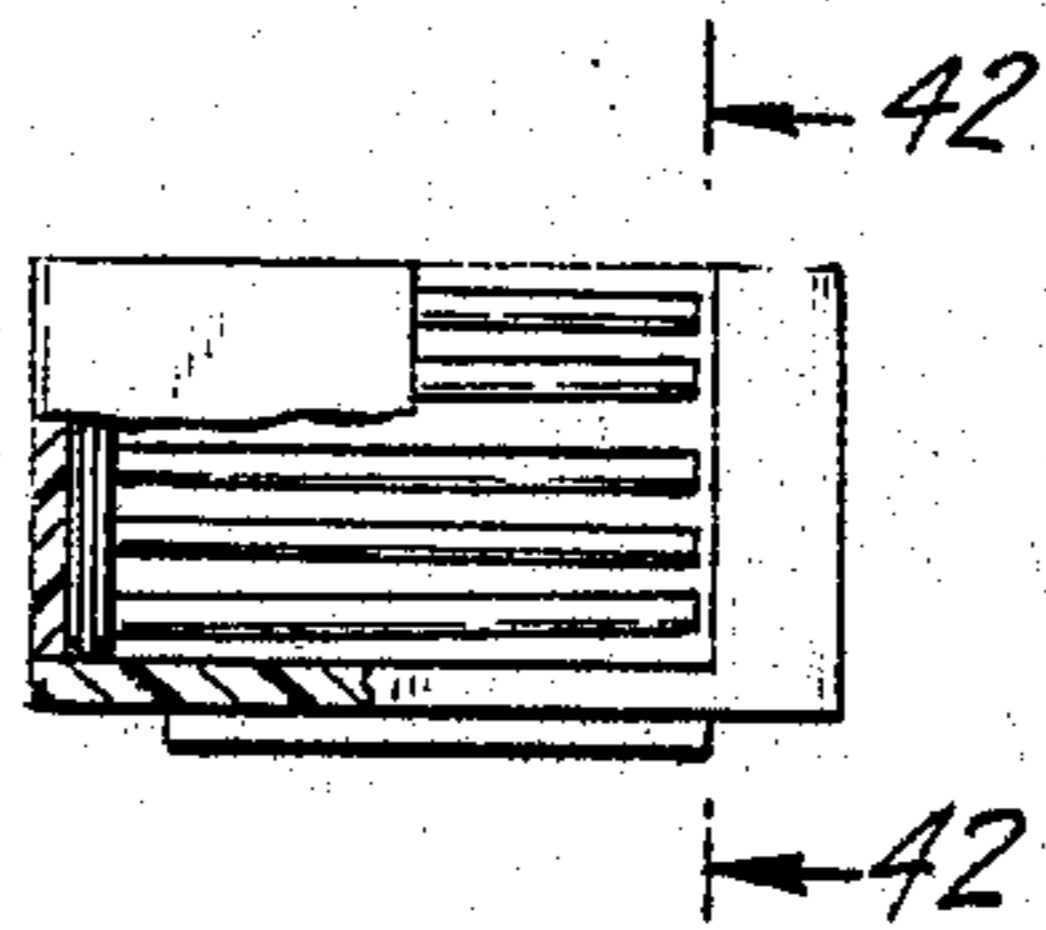

FIG. 42

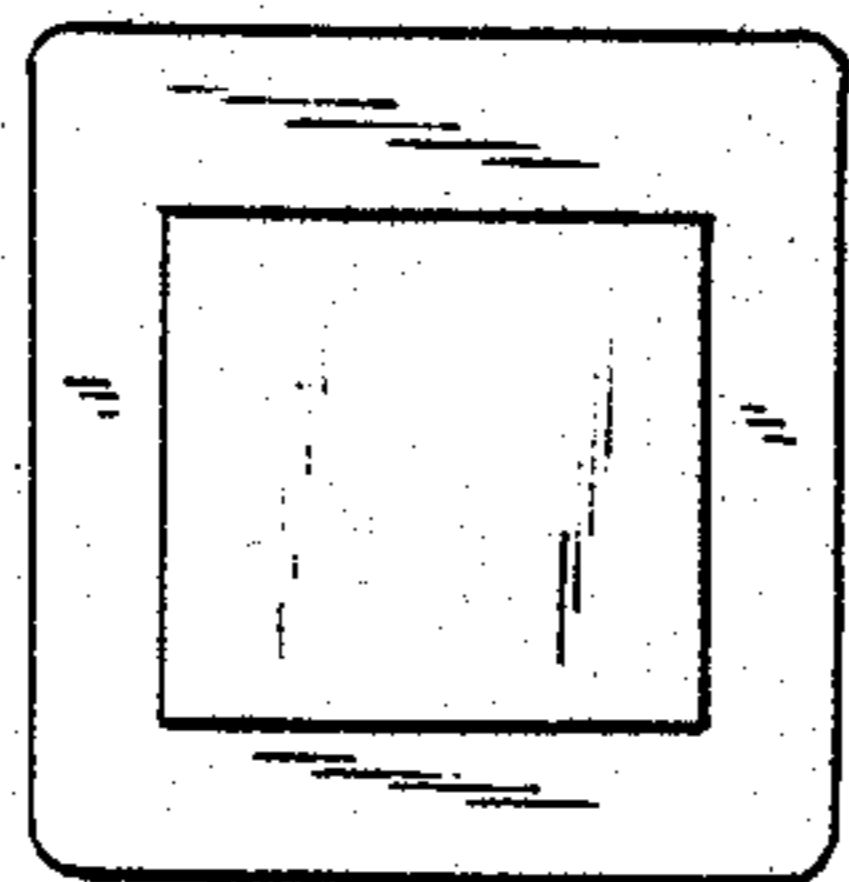

FIG. 39

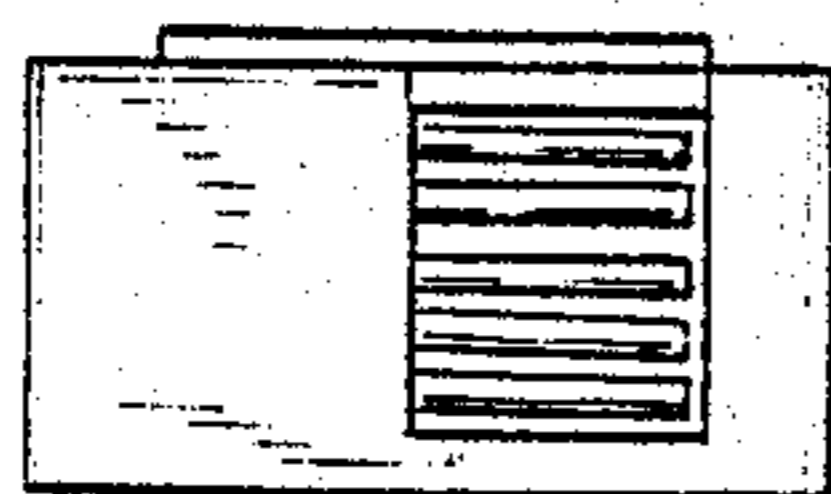

FIG. 40