

[54] CUP DISPENSER COLLAR

4,545,506 10/1985 Kadono 222/95

[75] Inventor: J. Marshall Suttles, Elberton, Ga.

Primary Examiner—Wallace R. Burke

[73] Assignee: Royston Corporation, Royston, Ga.

Assistant Examiner—Brian N. Vinson

[**] Term: 14 Years

Attorney, Agent, or Firm—Howson & Howson

[21] Appl. No.: 872,448

[57] CLAIM

The ornamental design for a cup dispenser collar, as shown and described.

[22] Filed: Jun. 9, 1986

[52] U.S. Cl. D6/516

[58] Field of Search D6/315-316;
242/55.42, 55.53, 55.54, 55.55; 206/233;
222/95; 221/303-304, 307-308, 310; 312/42-43

DESCRIPTION

FIG. 1 is a perspective view of a cup dispenser collar showing my new design;

FIG. 2 is a front elevational view thereof;

FIG. 3 is a rear elevational view thereof;

FIG. 4 is a right side elevational view thereof, the left side being a mirror image;

FIG. 5 is a top plan view thereof;

FIG. 6 is a bottom plan view thereof; and

FIG. 7 is a cross-sectional view thereof, taken along line 7-7 of FIG 3.

[56] References Cited

U.S. PATENT DOCUMENTS

- D. 237,536 11/1975 Hagglund et al. D6/522
- D. 277,246 1/1985 Sjöstedt et al. D6/523
- D. 277,911 3/1985 Lunden D6/523
- 4,319,696 3/1982 Stevens D6/516 X

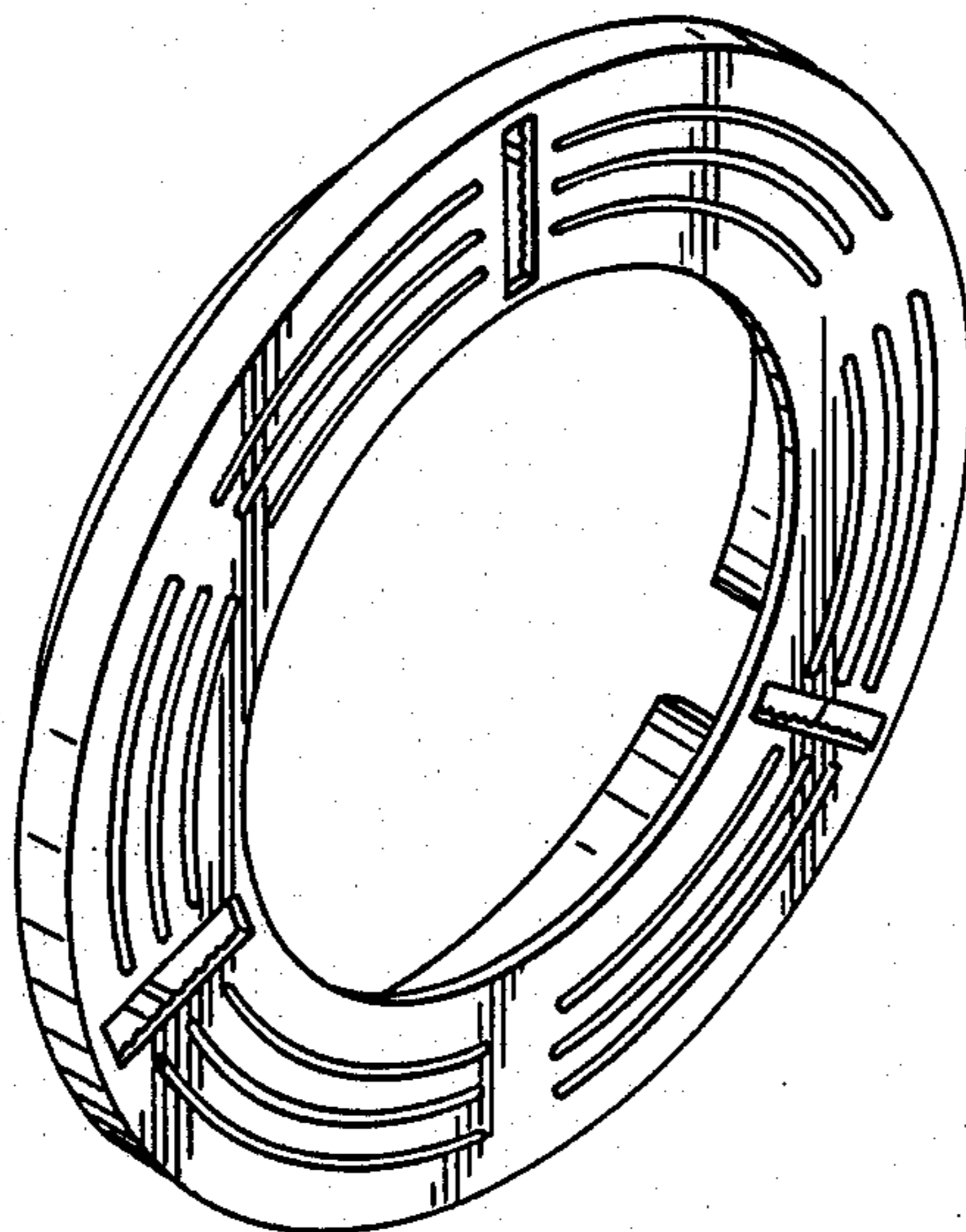

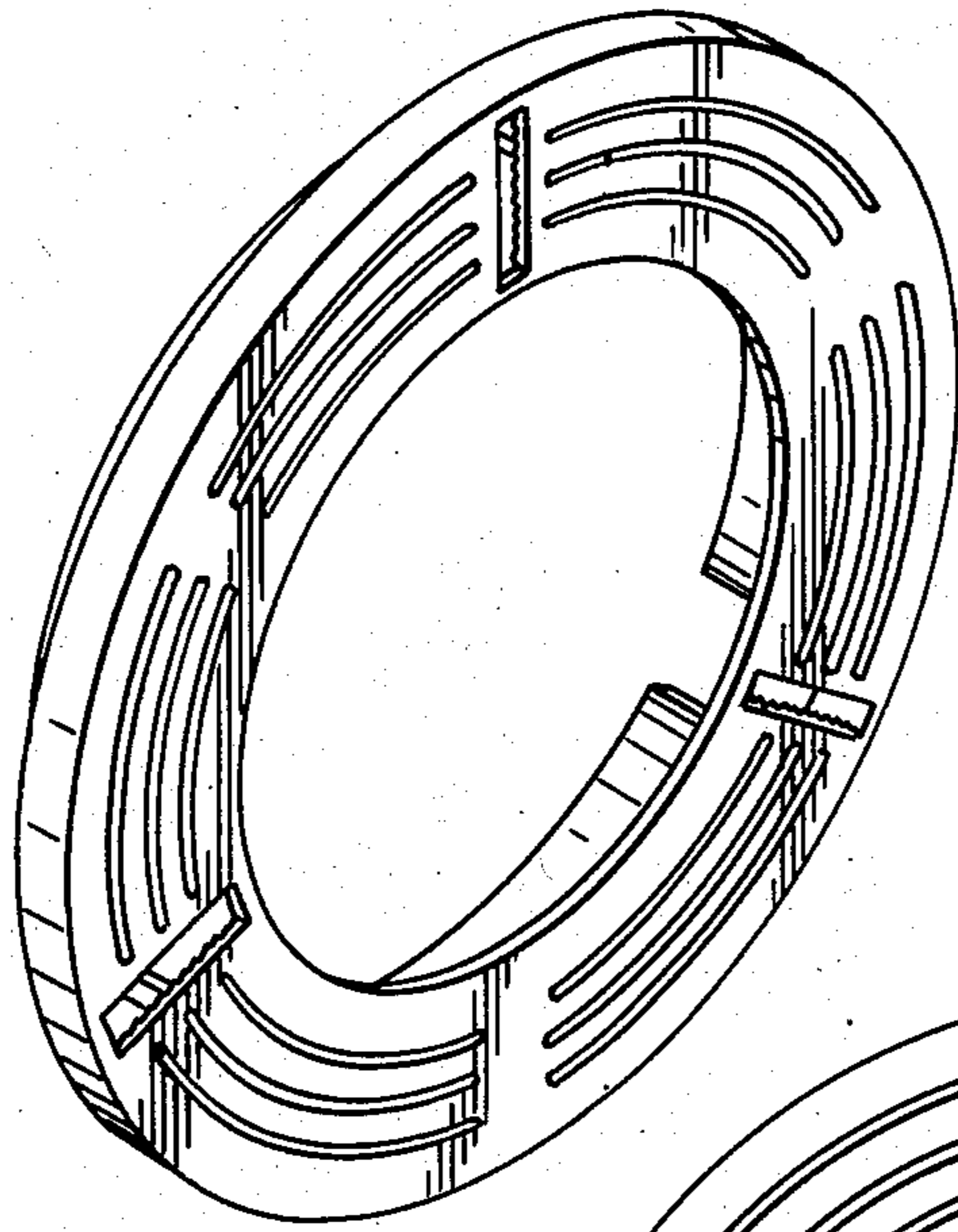

FIG. 1

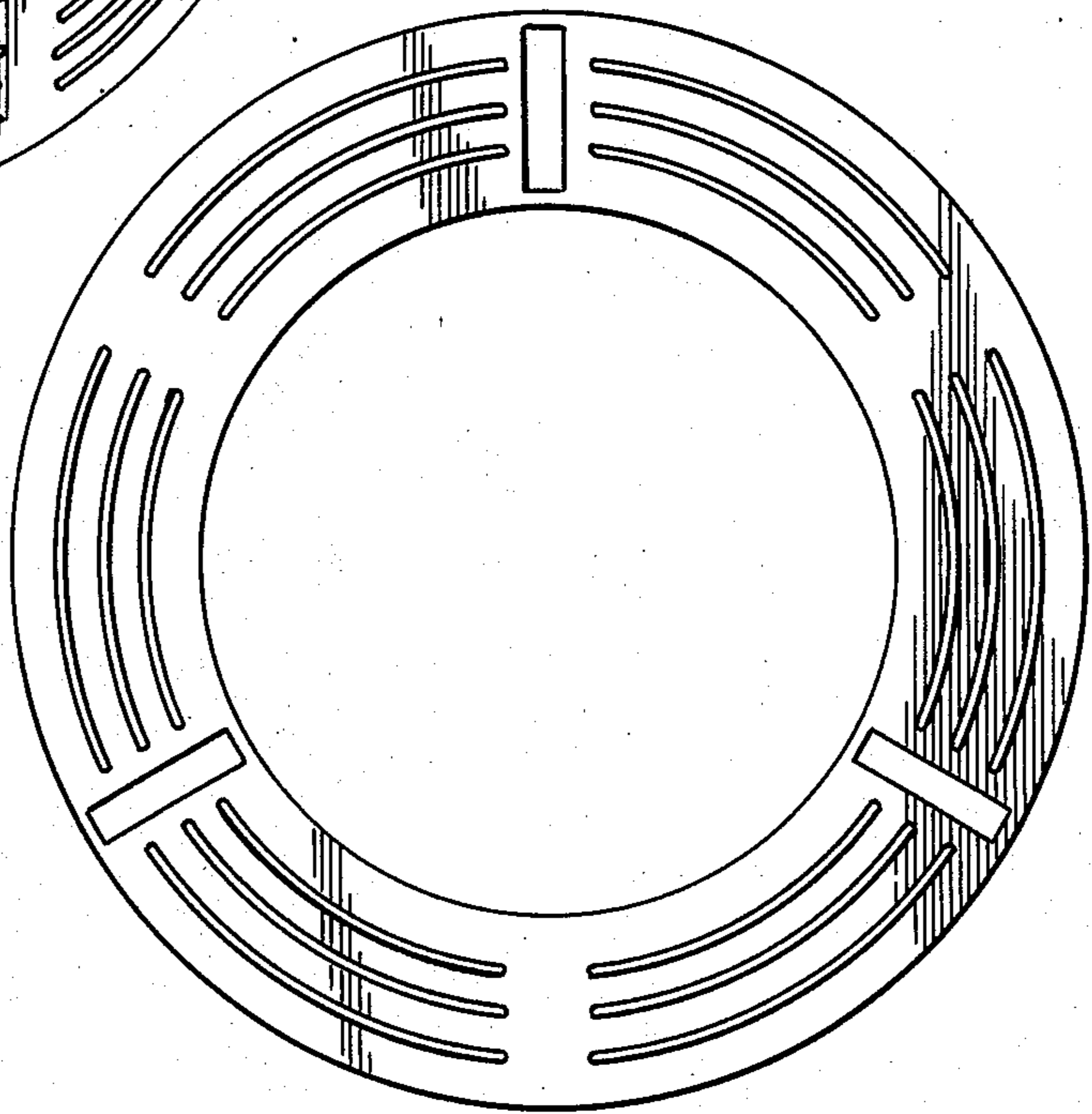

FIG. 2

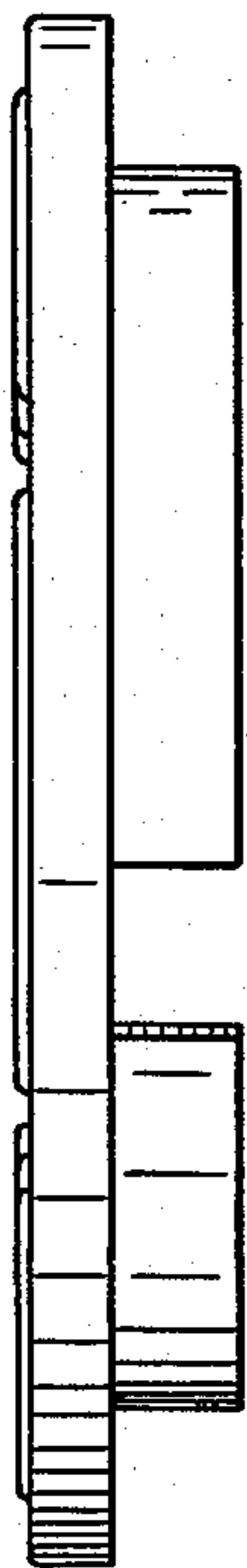

FIG. 4

FIG. 3

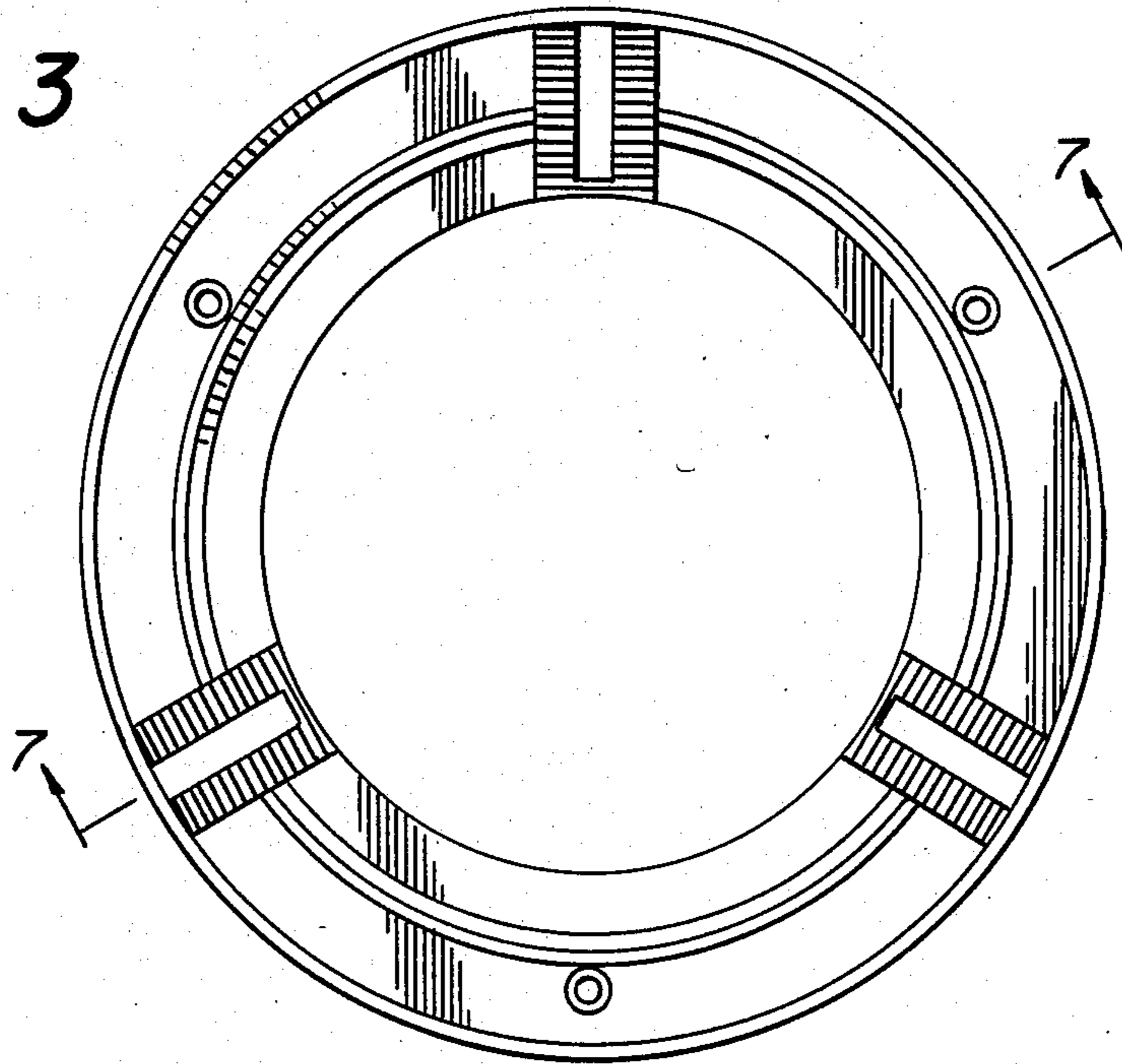

FIG. 7

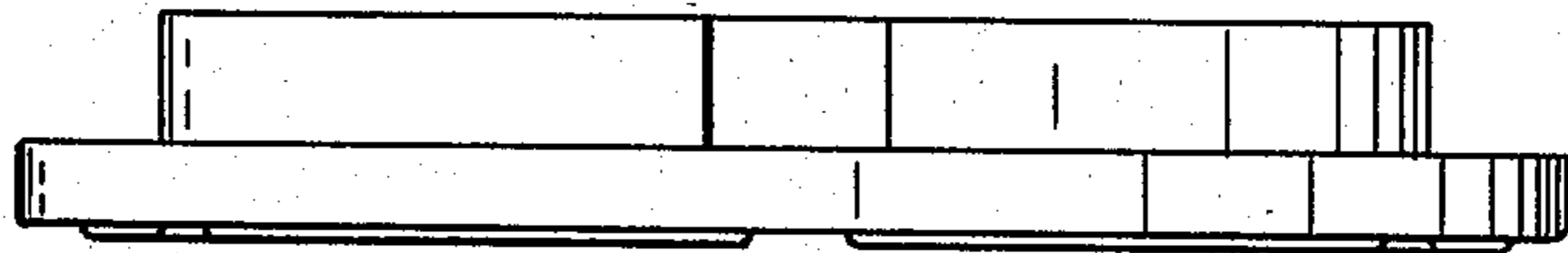
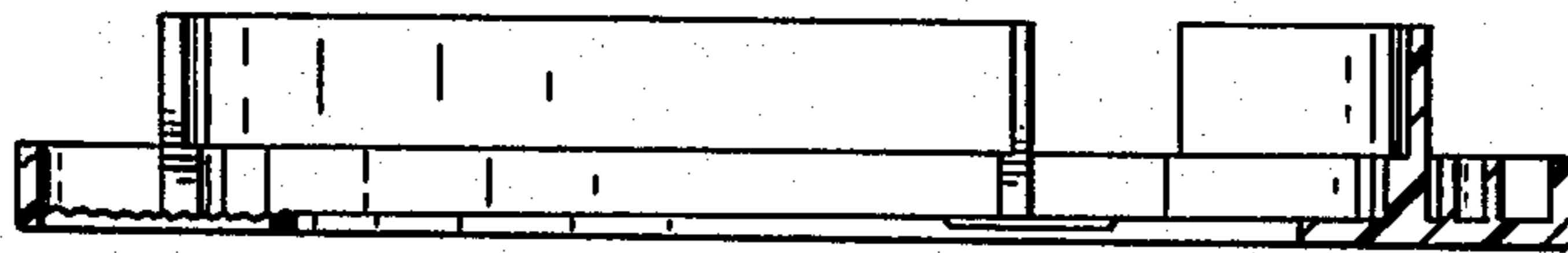

FIG. 5

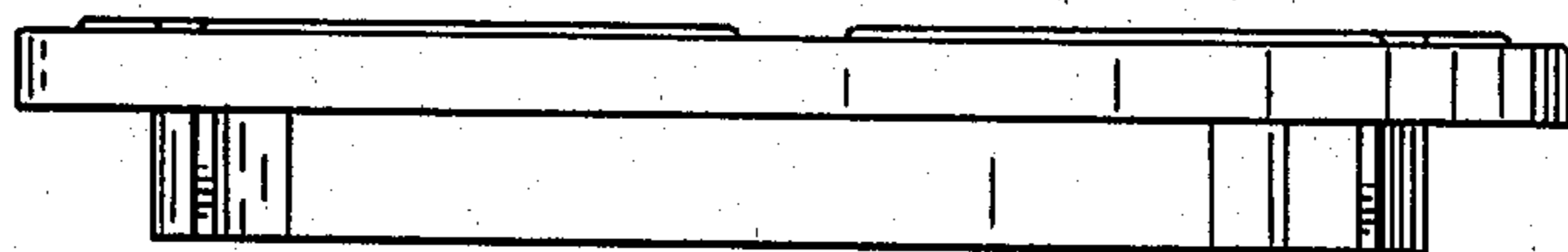

FIG. 6