

[54] **SCRATCH PAPER HOLDER**

[76] **Inventor:** Simon Bucher, 8706 West Oklahoma Ave., West Allis, Wis. 53227

[**] **Term:** 14 Years

[21] **Appl. No.:** 788,922

[22] **Filed:** Oct. 18, 1985

[52] **U.S. Cl.** D19/92

[58] **Field of Search** D19/65, 75, 70, 86, D19/88, 91, 92, 95; 402/501, 502, 70, 71, 1

[56] **References Cited**

U.S. PATENT DOCUMENTS

D. 122,471 9/1940 Seigenberg D19/92
D. 226,241 1/1973 Zelenko D19/92
D. 228,083 8/1973 Longarzo D19/78

OTHER PUBLICATIONS

Evans 1983-1984 Catalog, p. 293, Item #14-Memo Pad Holder.

Primary Examiner—Charles A. Rademaker
Attorney, Agent, or Firm—Andrus, Scales, Starke & Sawall

[57] **CLAIM**

The ornamental design for a scratch paper holder, as shown and described.

DESCRIPTION

FIG. 1 is a perspective view of a scratch paper holder showing my new design;
FIG. 2 is a top plan view thereof;
FIG. 3 is a side elevational view thereof;
FIG. 4 is a front elevational view thereof;
FIG. 5 is a rear elevational view thereof; and
FIG. 6 is a bottom plan view thereof.

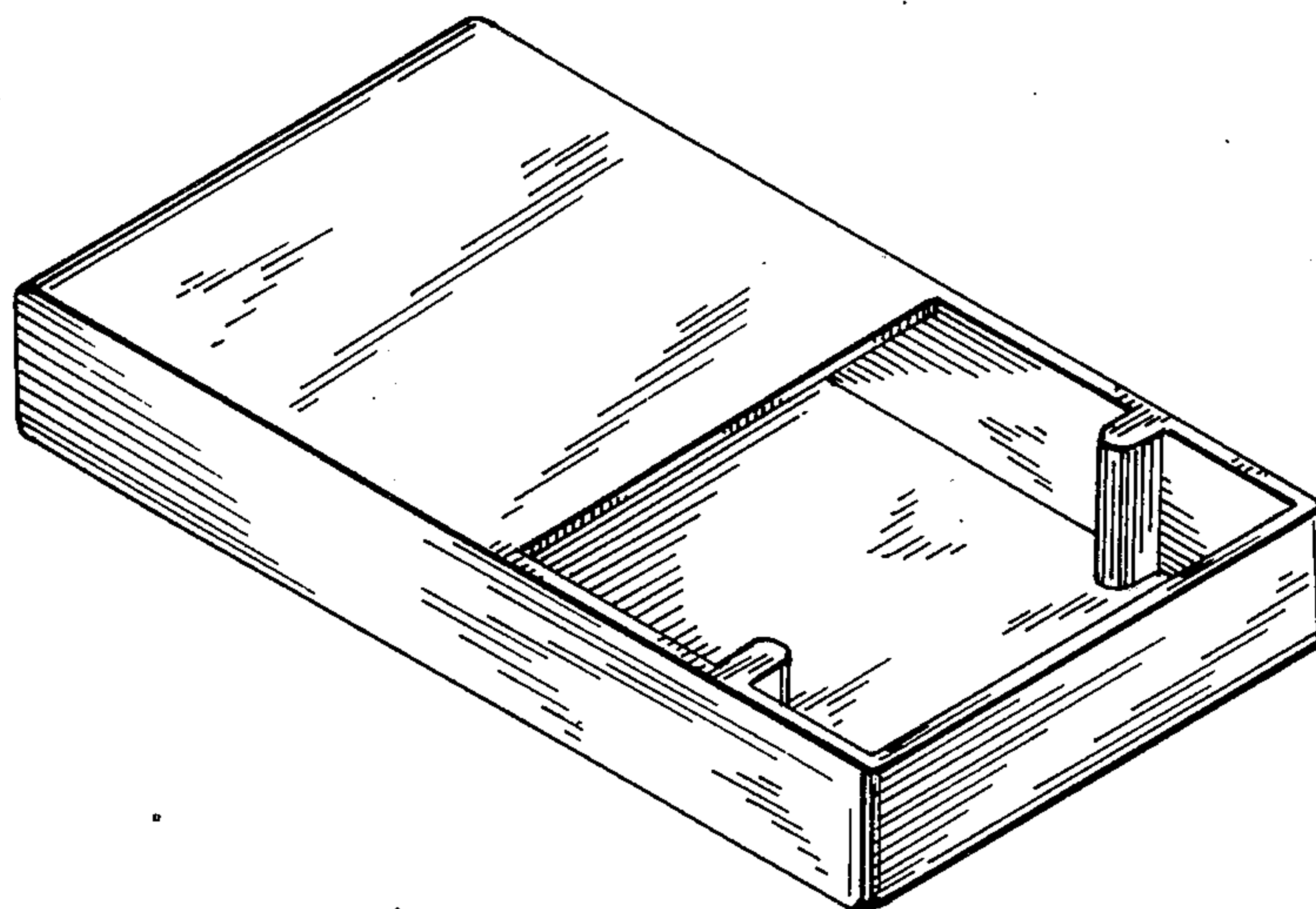

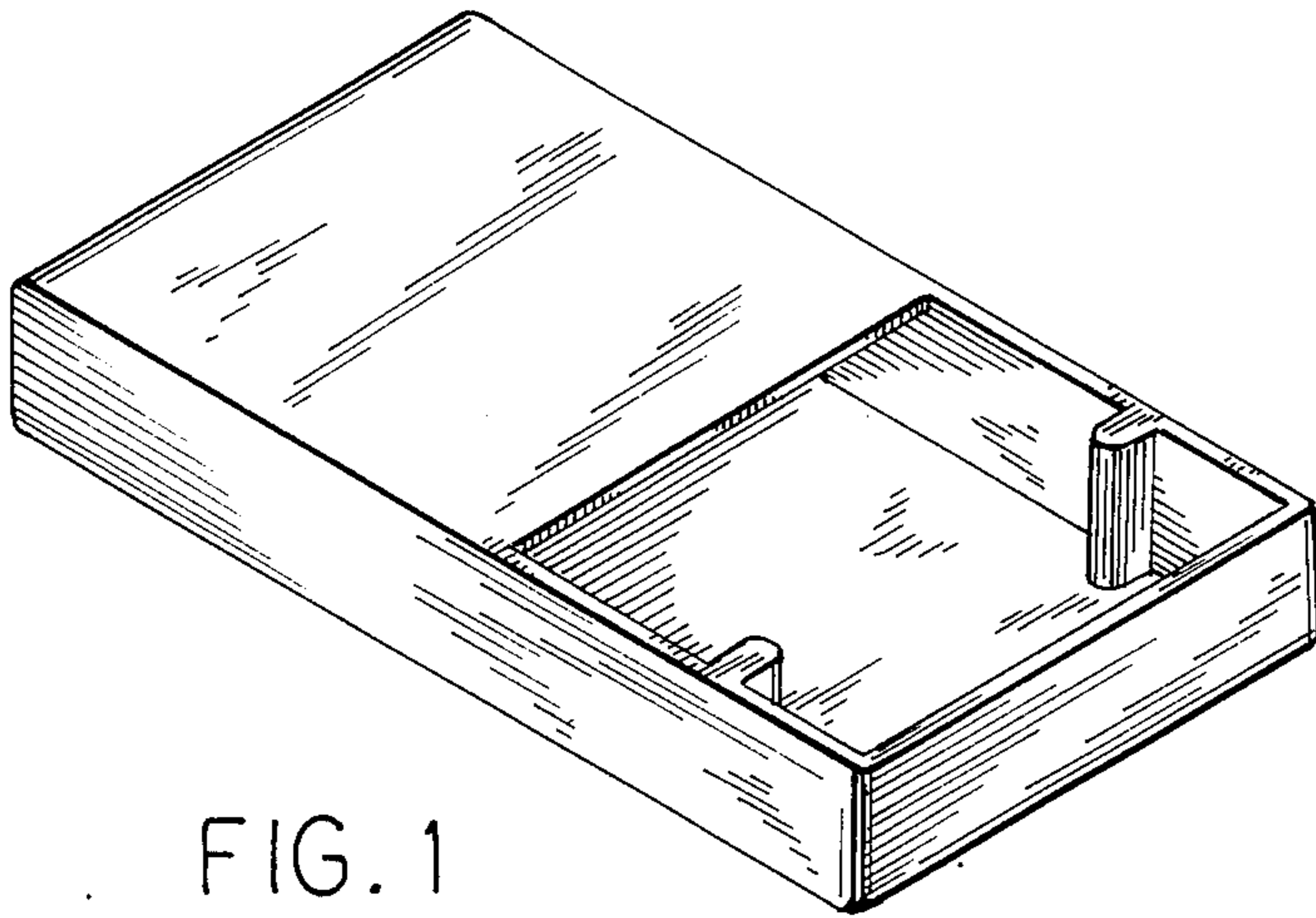

FIG. 1

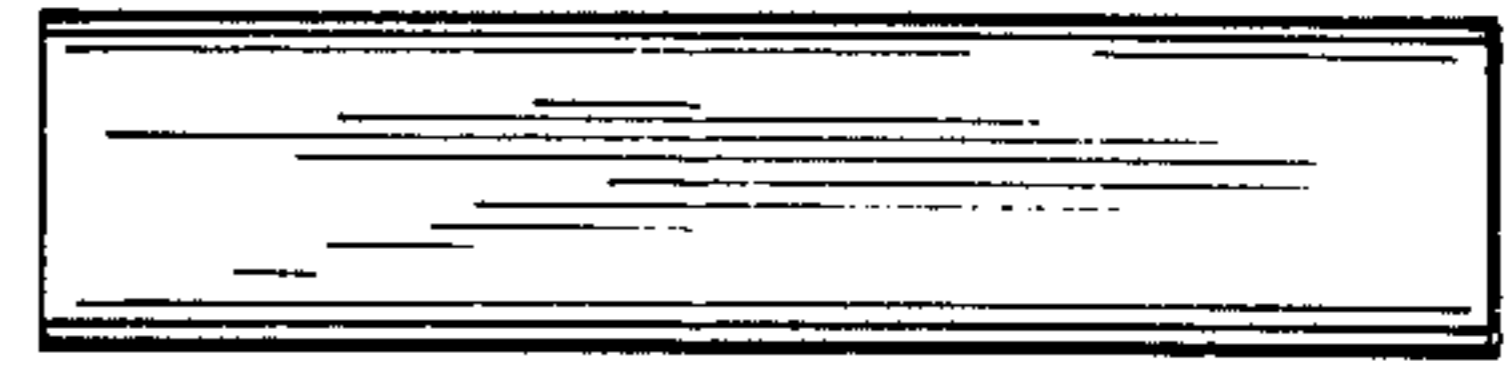

FIG. 5

FIG. 2

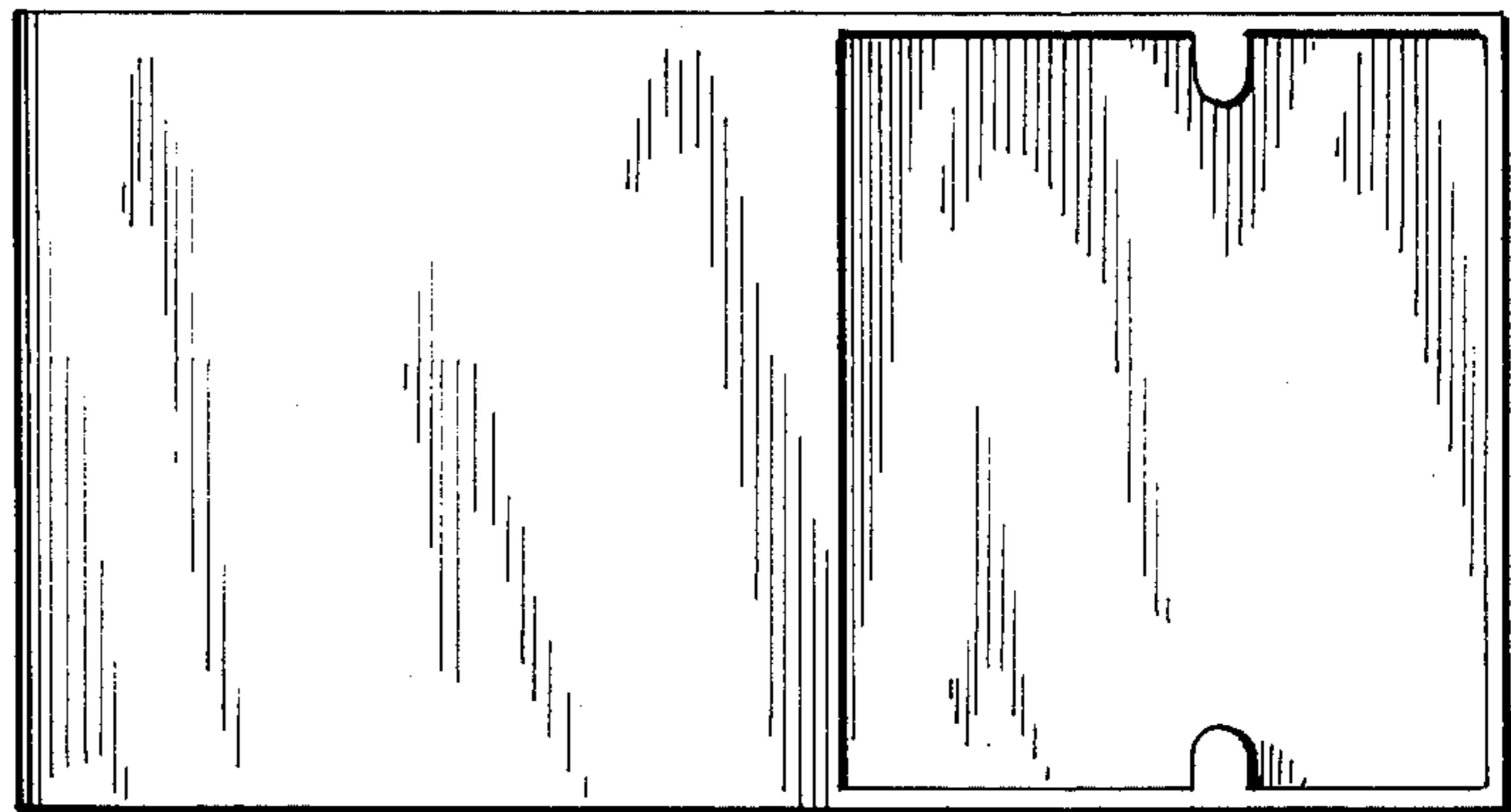

FIG. 3

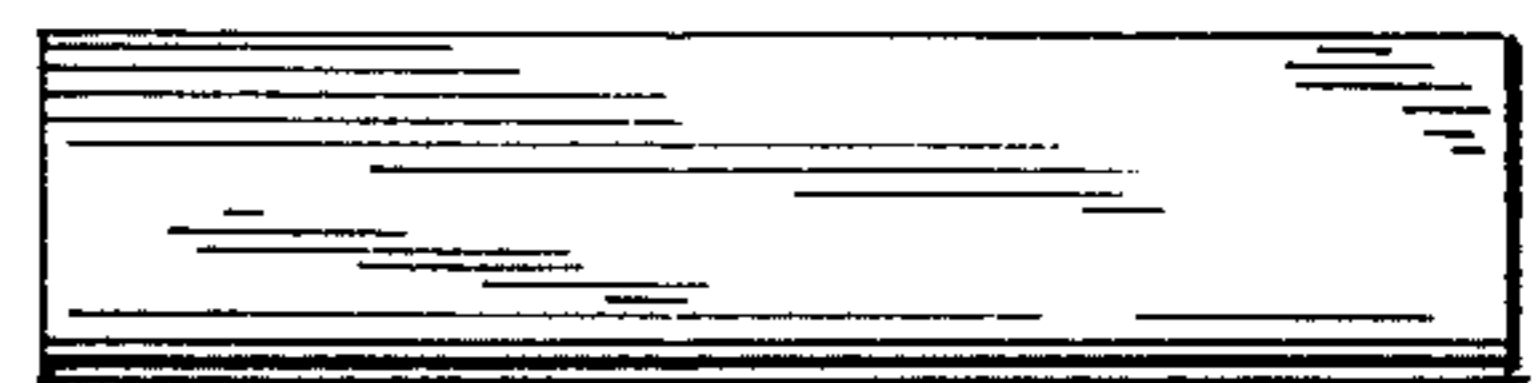
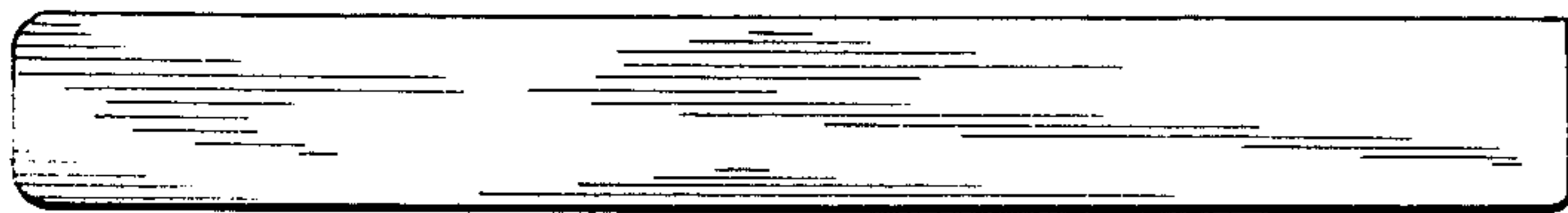

FIG. 4

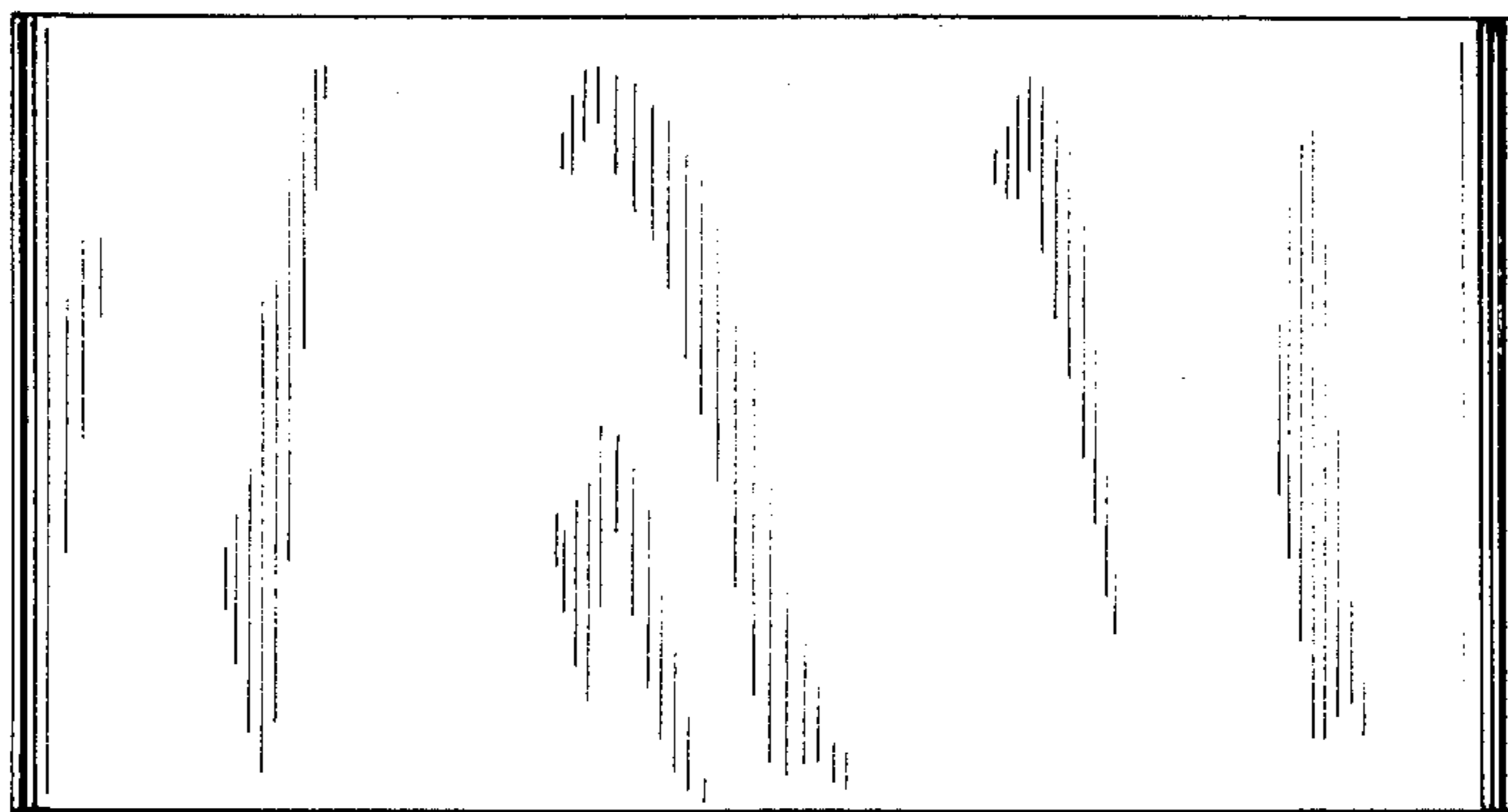

FIG. 6