

[54] **T SHAPED JACK**

[76] **Inventor:** William D. Murray, Jr., Rte. 1, Box 744, Avinger, Tex. 75630

[**] **Term:** 14 Years

[21] **Appl. No.:** 887,648

[22] **Filed:** Jul. 21, 1986

[52] **U.S. Cl.** D34/31

[58] **Field of Search** D34/28, 31, 32; 254/88, 254/81, 93 HP; 248/354, 165

[56] **References Cited**

U.S. PATENT DOCUMENTS

3,863,895	2/1975	Grewe et al.	D34/32
3,994,474	11/1976	Finkbeiner	254/93 HP
4,103,870	8/1978	Murakami	D34/32
4,194,724	3/1980	Masegian	254/88

FOREIGN PATENT DOCUMENTS

1416349 9/1965 France 254/88

Primary Examiner—Wallace R. Burke
Assistant Examiner—Kay H. Chin
Attorney, Agent, or Firm—Johnson & Swanson

[57] **CLAIM**

The ornamental design for a T shaped jack, as shown and described.

DESCRIPTION

FIG. 1 is a perspective view of a T shaped jack showing my new design;
FIG. 2 is a right side elevational view thereof, the left side elevational view being a mirror image of that shown;
FIG. 3 is a rear elevational view thereof;
FIG. 4 is a front elevational view thereof;
FIG. 5 is a top plan view thereof; and,
FIG. 6 is a bottom plan view thereof.

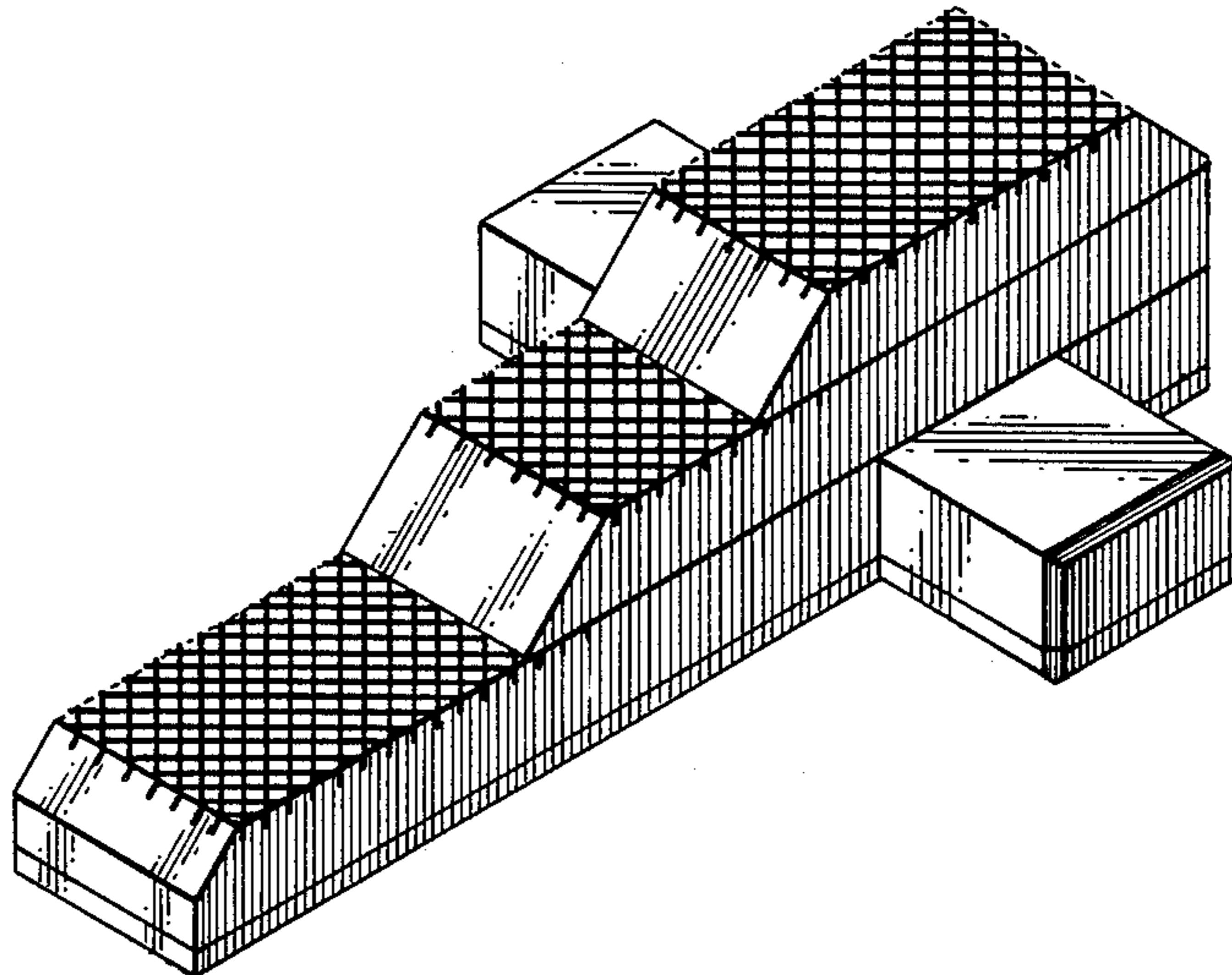

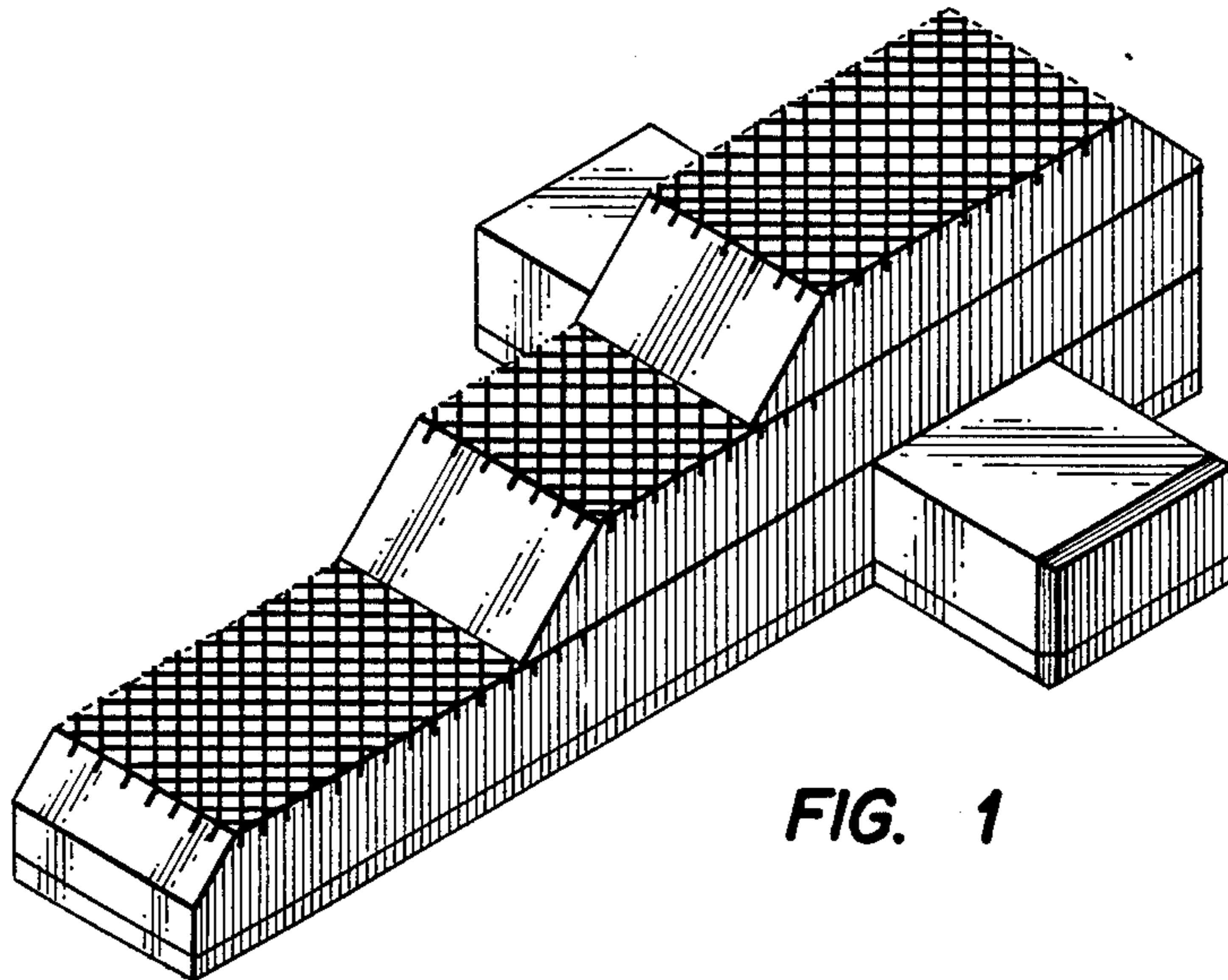

FIG. 1

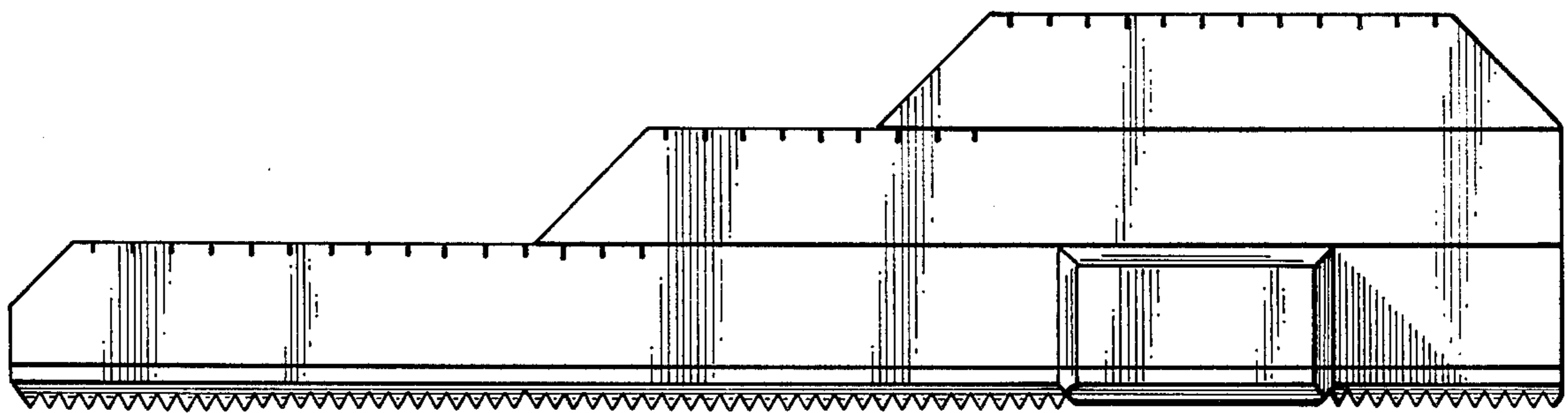

FIG. 2

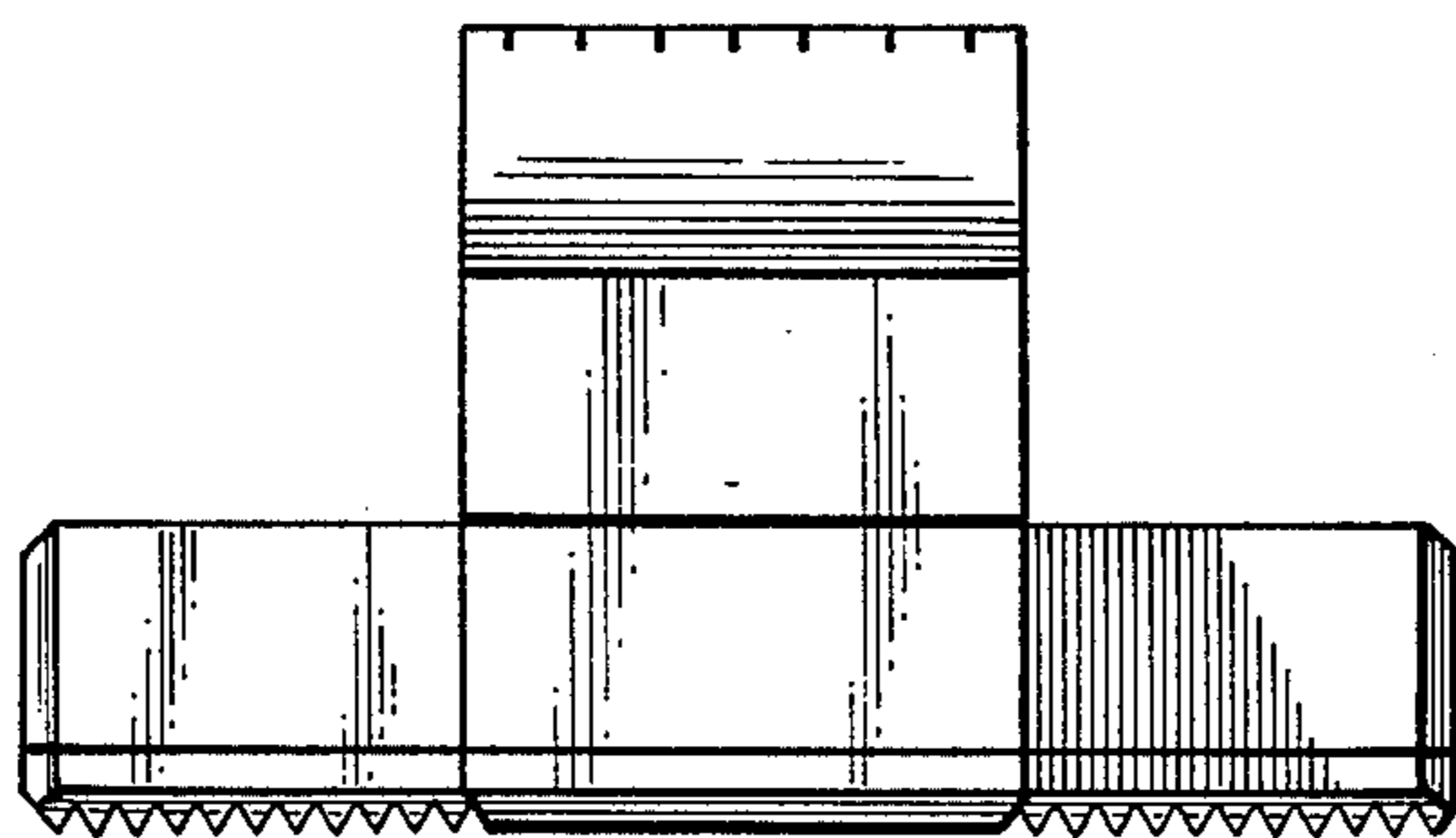

FIG. 3

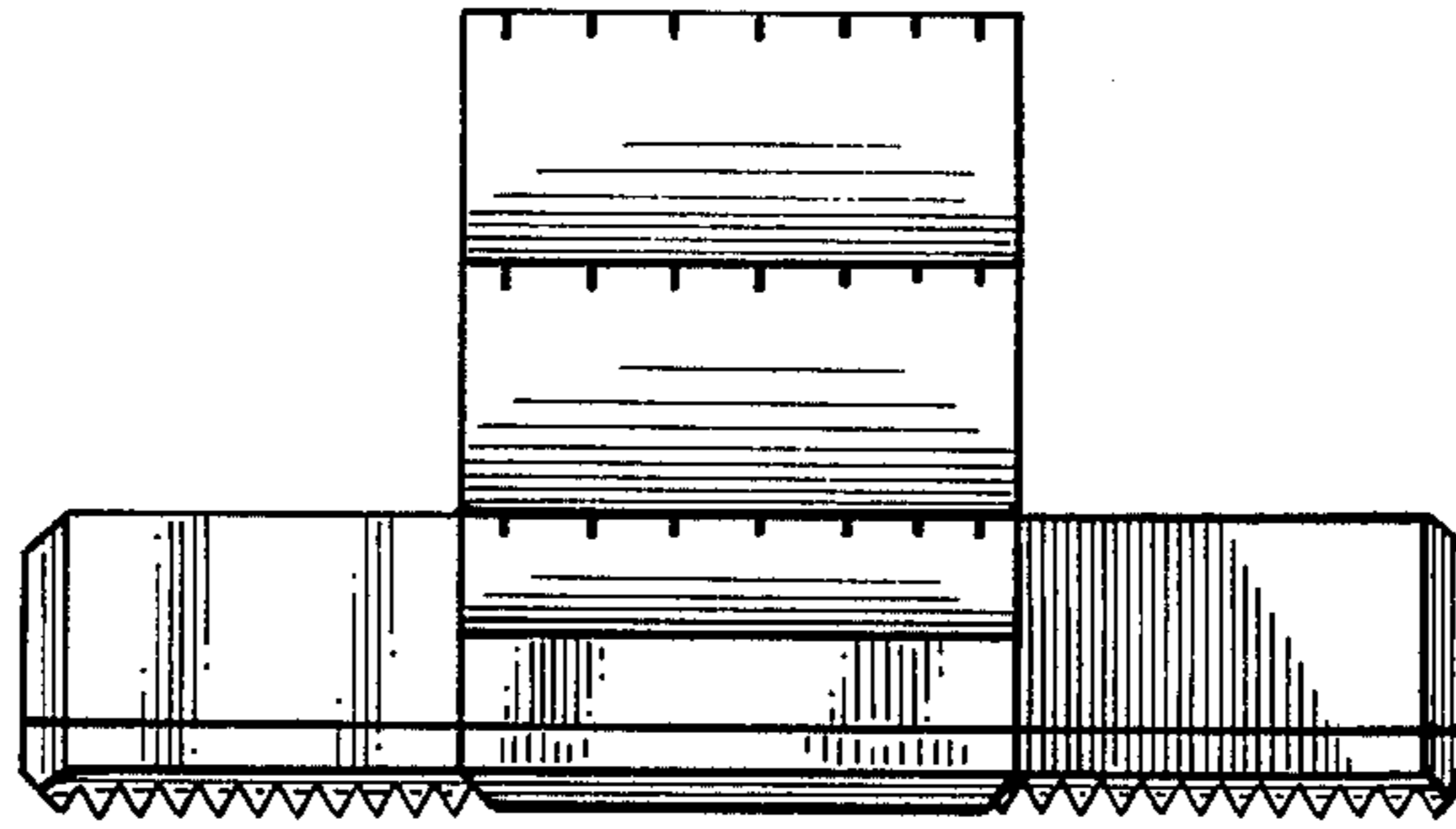

FIG. 4

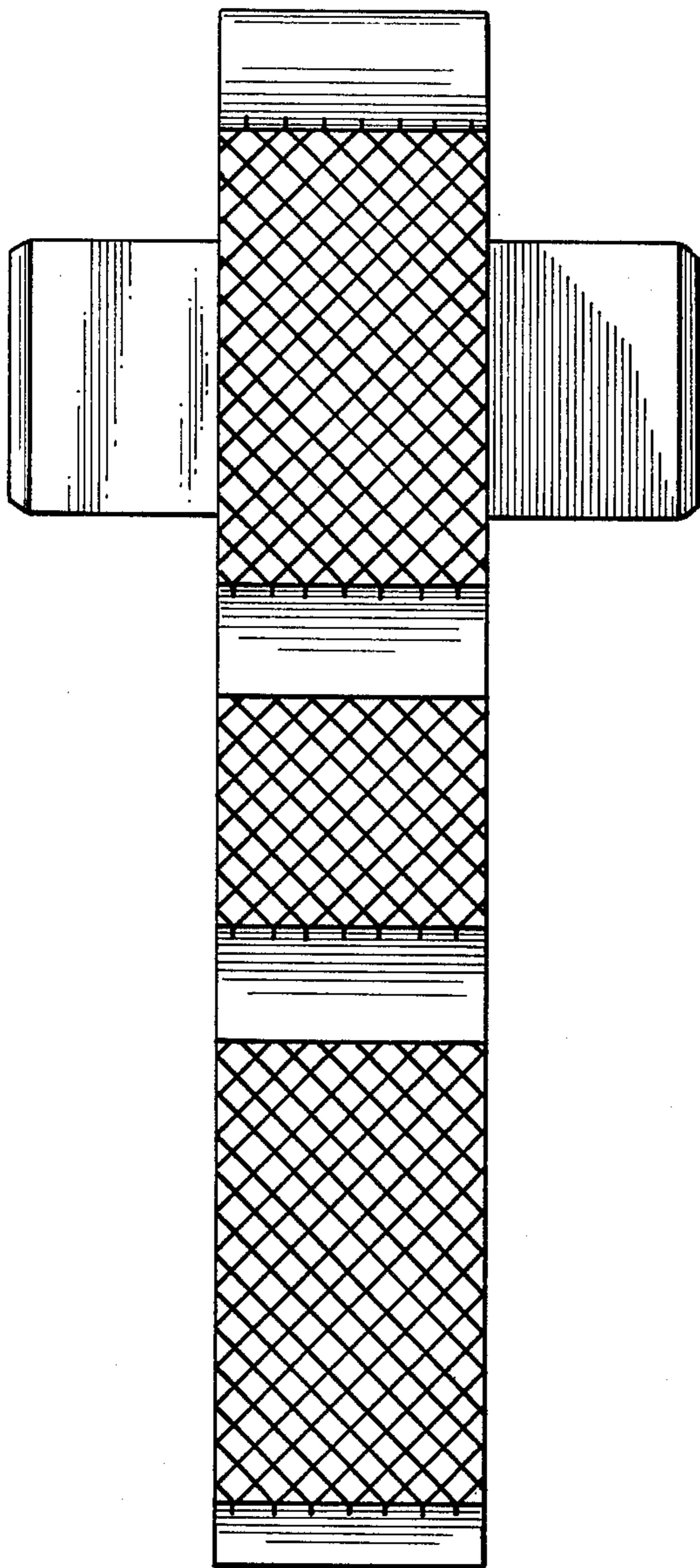

FIG. 5

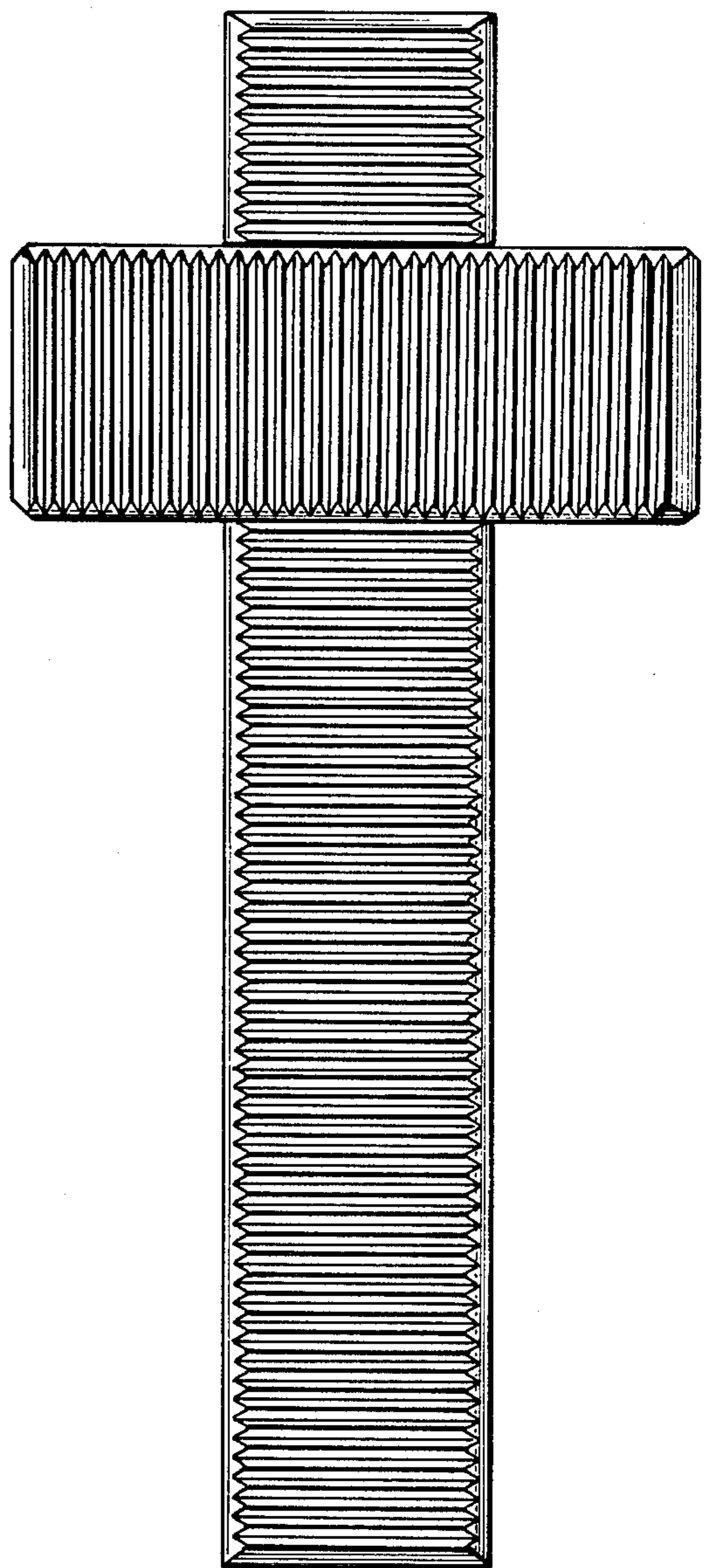

FIG. 6