

- [54] LIPSTICK CASE
- [75] Inventor: Theodore Simonetti, New York, N.Y.
- [73] Assignee: L'Oreal S.A., Paris, France
- [\*\*] Term: 14 Years
- [21] Appl. No.: 875,744
- [22] Filed: Jun. 17, 1986
- [52] U.S. Cl. .... D28/85; D28/89
- [58] Field of Search ..... D28/4-9,  
D28/73-91.1; D3/39; D9/338, 377, 414, 420,  
430, 432; 220/DIG. 26; 206/235, 385, 581, 823;  
132/79 R, 79 A, 79 C, 82 R, 82 A, 83 B, 88.5,  
88.7

- D. 279,510 7/1985 Kalrawicz ..... D28/85
- D. 279,827 7/1985 Buchet ..... D28/85
- D. 287,339 12/1986 Dominski ..... D9/377

Primary Examiner—Louis S. Zarfaz  
 Attorney, Agent, or Firm—Brumbaugh, Graves,  
 Donohue & Raymond

[57] CLAIM

The ornamental design for a lipstick case, as shown and described.

DESCRIPTION

FIG. 1 is a front elevational view of a lipstick case showing my new design, the rear and sides being the same;  
 FIG. 2 is a top plan view thereof;  
 FIG. 3 is a bottom plan view thereof;  
 FIG. 4 is an edge elevational view taken by rotating the case forty-five degrees from the front elevational view; and  
 FIG. 5 is an exploded perspective view thereof.

- [56] **References Cited**
- U.S. PATENT DOCUMENTS**
- D. 85,363 10/1931 Betts ..... D9/377
- D. 153,859 5/1949 Crane ..... D28/85
- D. 246,998 1/1978 Hill ..... D28/7

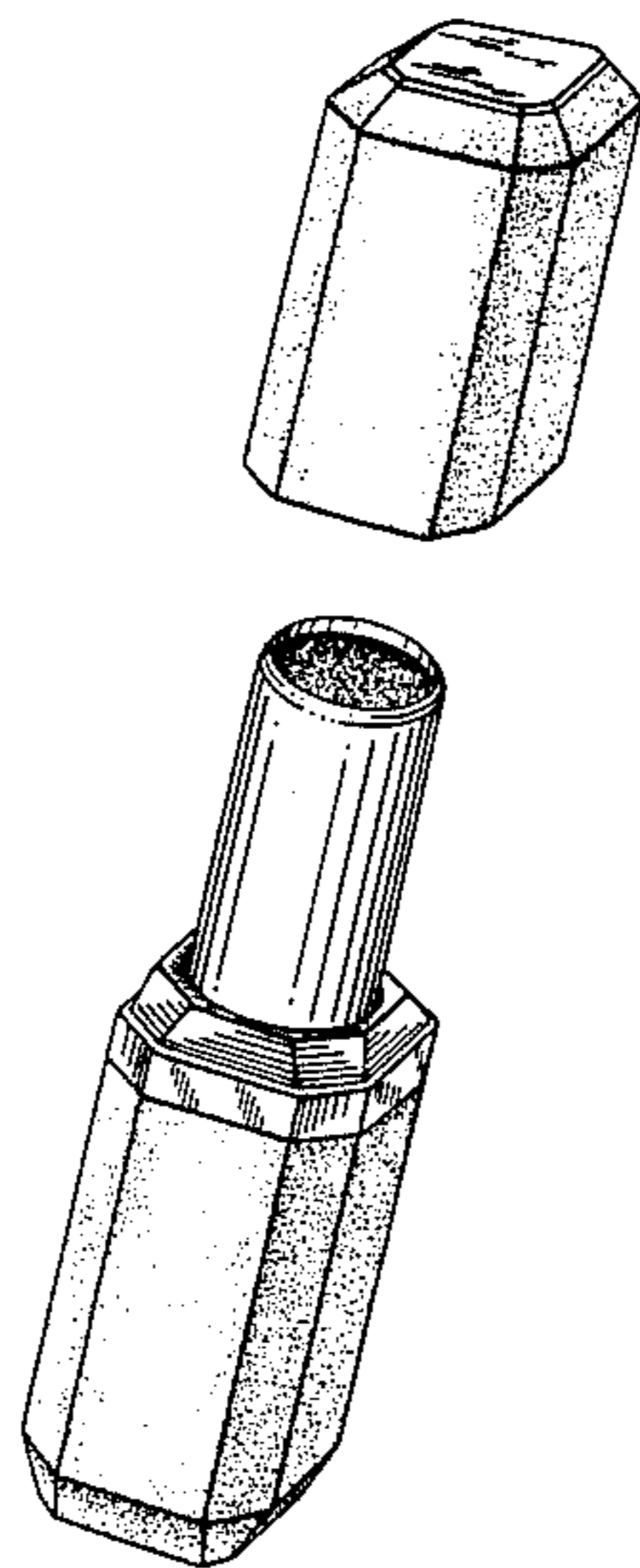

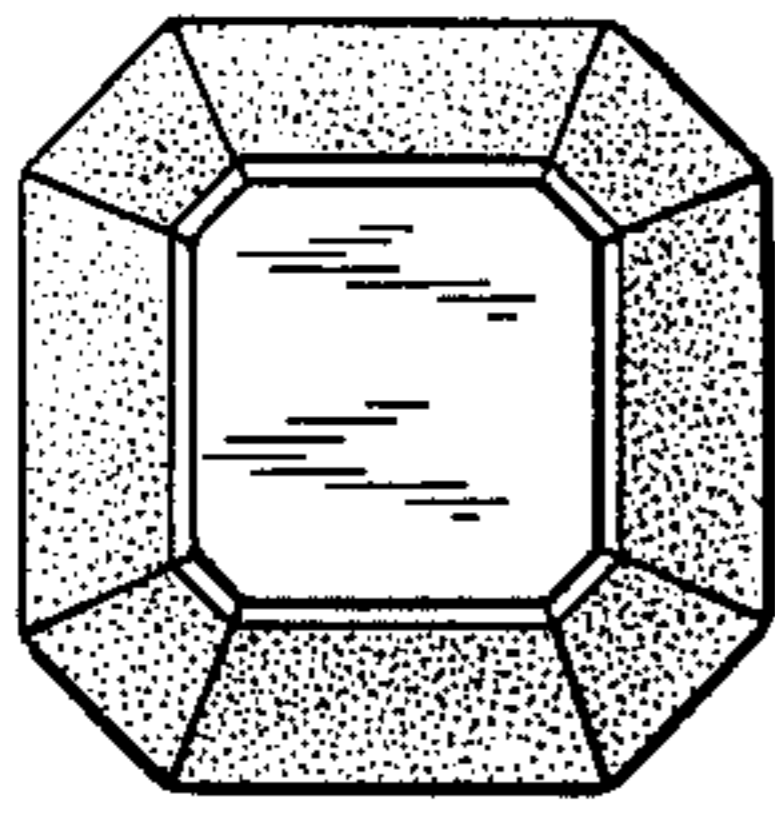

FIG. 2

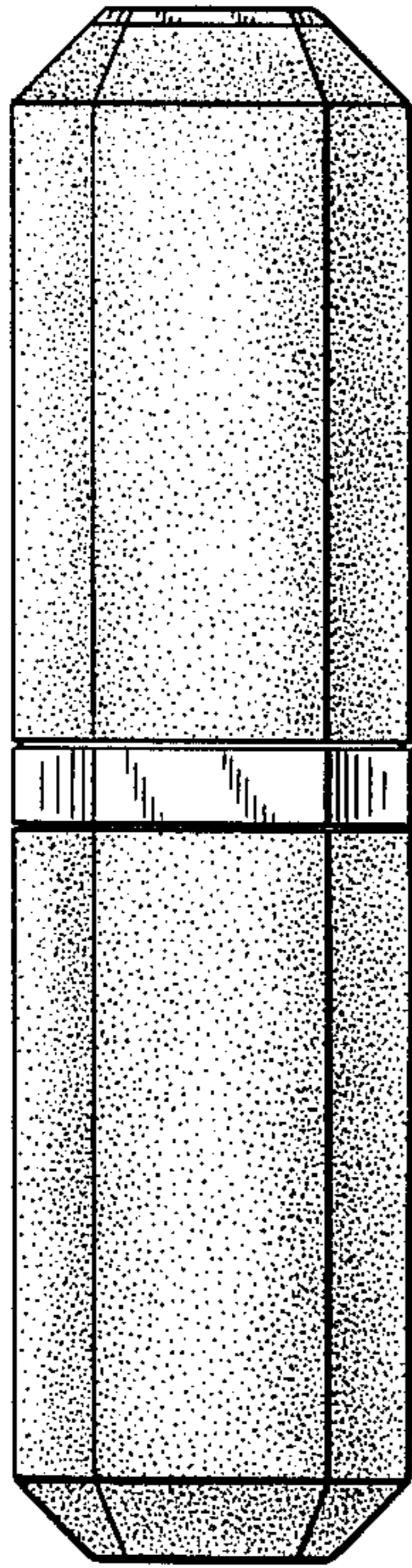

FIG. 1

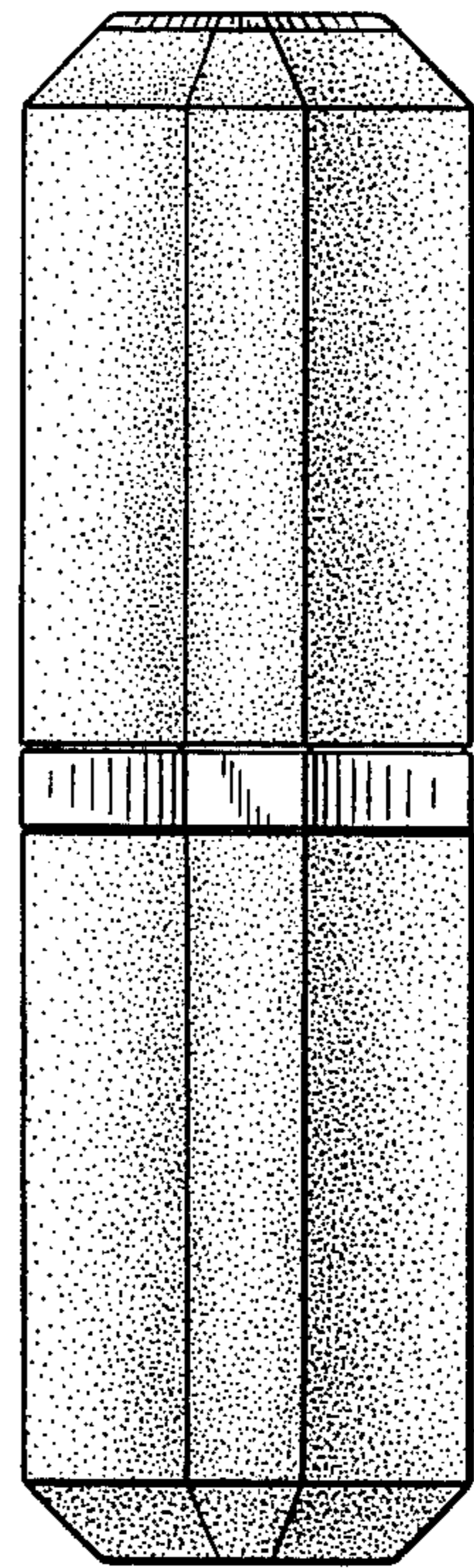

FIG. 4

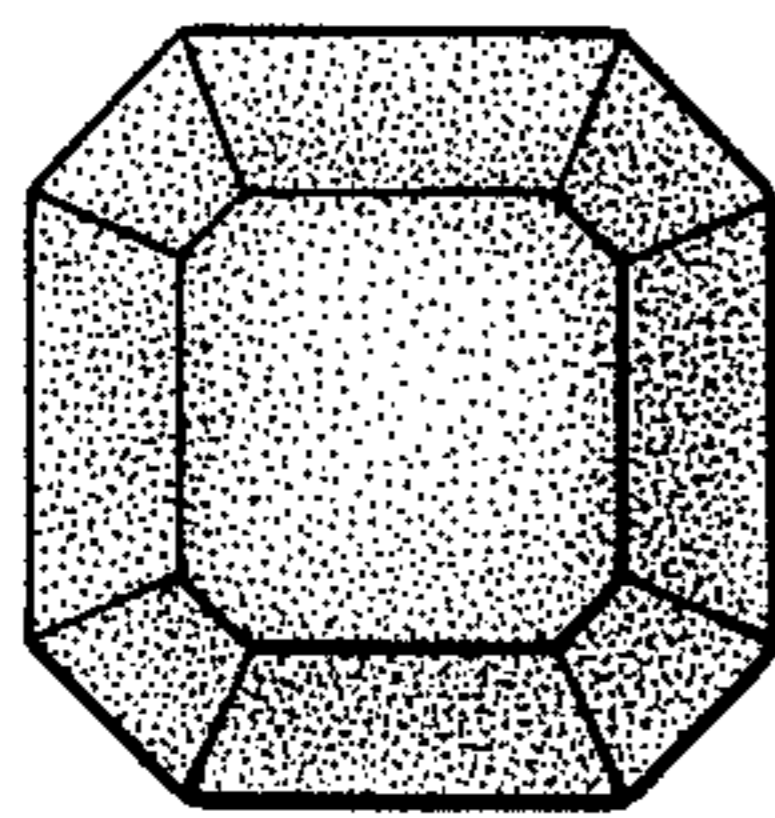

FIG. 3

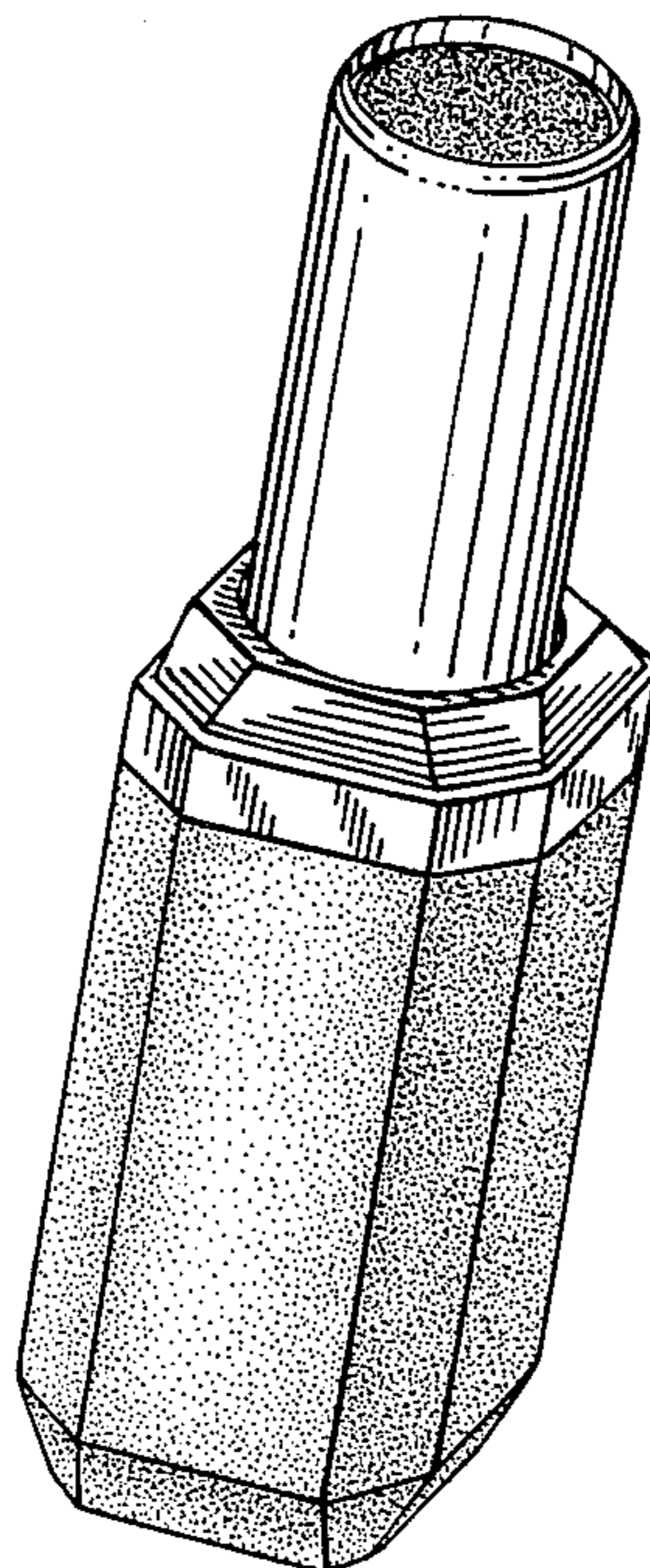
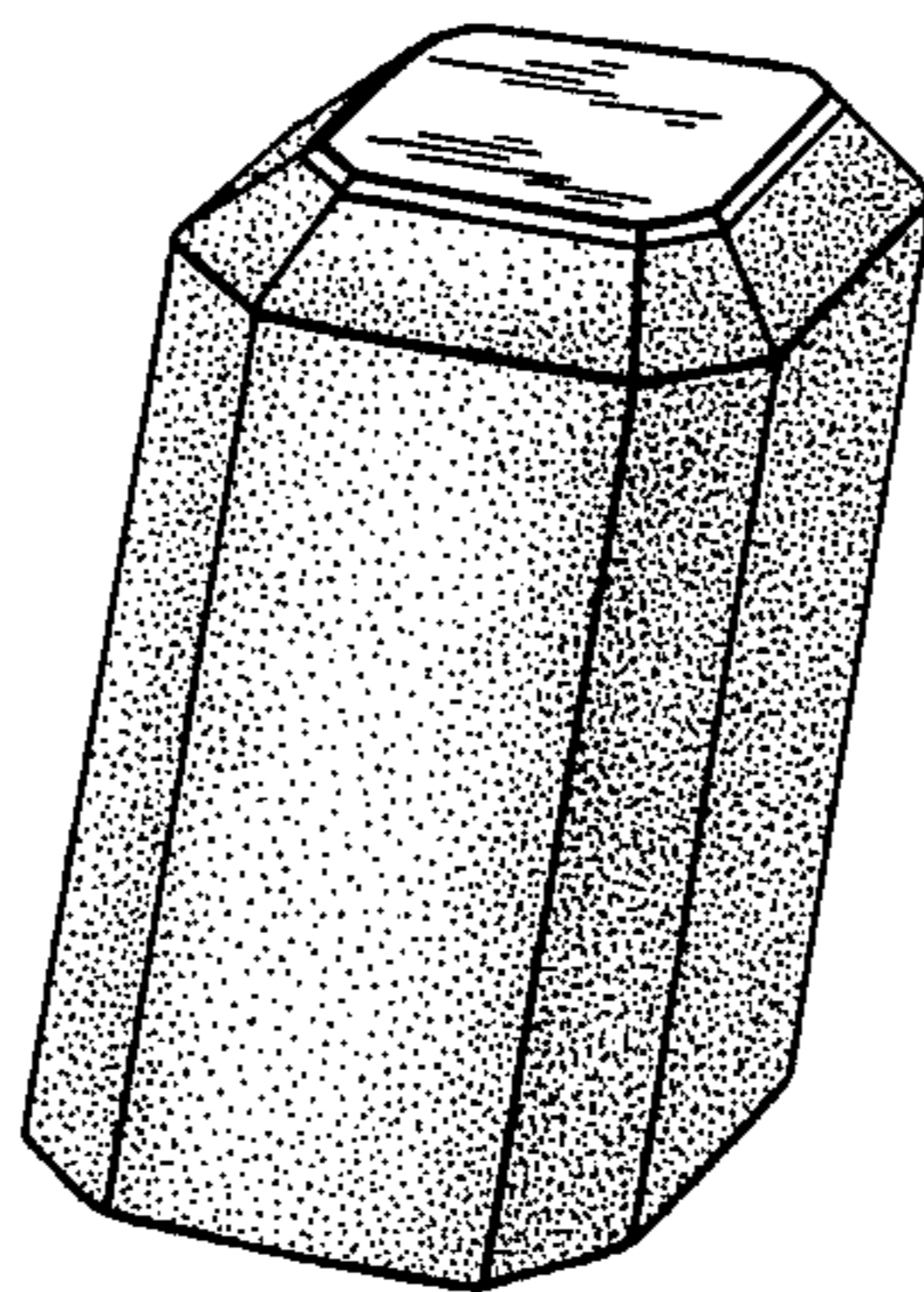

FIG. 5