

[54] HUMIDIFIER

[75] Inventors: Russell E. Ihlenfeld, Reedsburg;  
Joseph T. Reeder, Wisconsin Dells,  
both of Wis.

[73] Assignee: Gerber Products Company, Fremont,  
Mich.

[\*\*] Term: 14 Years

[21] Appl. No.: 931,301

[22] Filed: Nov. 14, 1986

[52] U.S. Cl. .... D23/356

[58] Field of Search ..... D23/355-356,  
D23/360, 364, 366; 239/34, 136, 144, 302;  
261/72.1, 98, DIG. 4, DIG. 15, DIG. 48, DIG.  
65; 312/31; 219/271-273, 275

[56] References Cited

U.S. PATENT DOCUMENTS

- D. 287,275 12/1986 Uchida ..... D23/356
- D. 287,755 1/1987 Imai et al. .... D23/356
- D. 288,597 3/1987 Young ..... D23/356
- D. 289,325 4/1987 Nishikawa ..... D23/356

Primary Examiner—Wallace R. Burke  
Assistant Examiner—Brian N. Vinson  
Attorney, Agent, or Firm—Townsend and Townsend

[57] CLAIM

The ornamental design for a humidifier, as shown and described.

DESCRIPTION

FIG. 1 is a perspective view of a humidifier showing my new design;  
FIG. 2 is a top plan view thereof;  
FIG. 3 is a front elevational view thereof;  
FIG. 4 is a right side elevational view thereof;  
FIG. 5 is a left side elevational view thereof;  
FIG. 6 is a rear elevational view thereof; and  
FIG. 7 is a bottom plan view thereof.

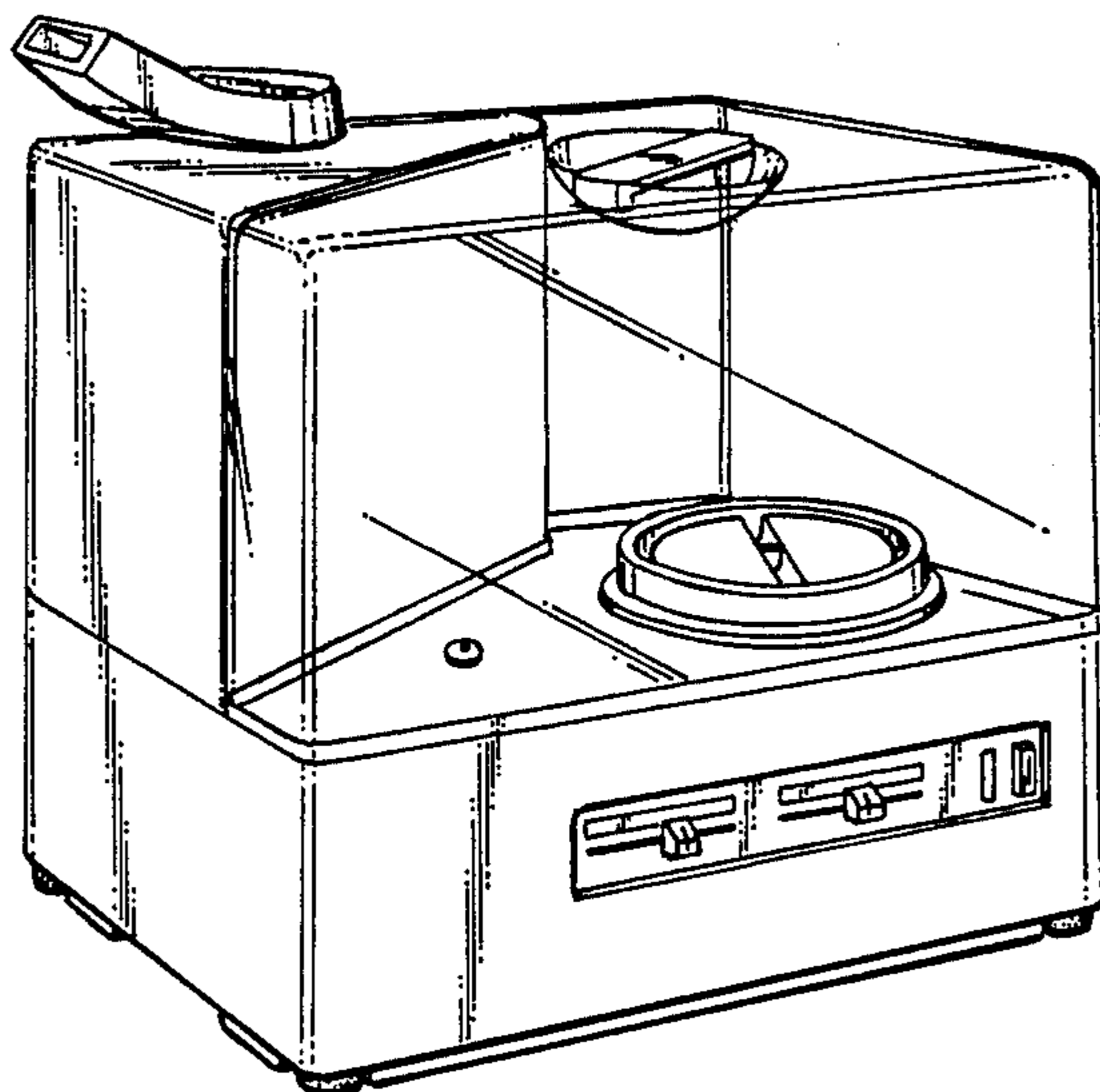

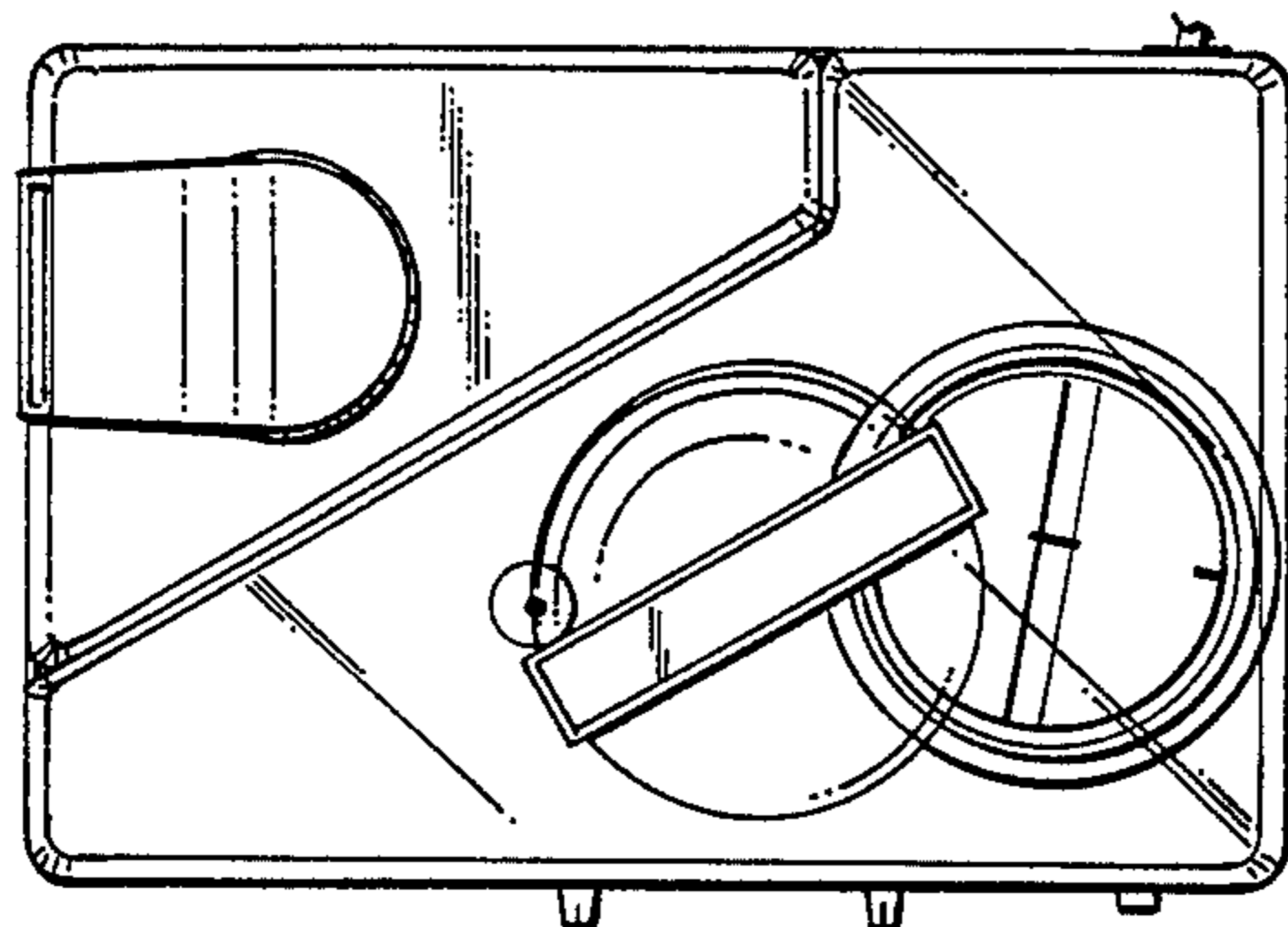

FIG. 2.

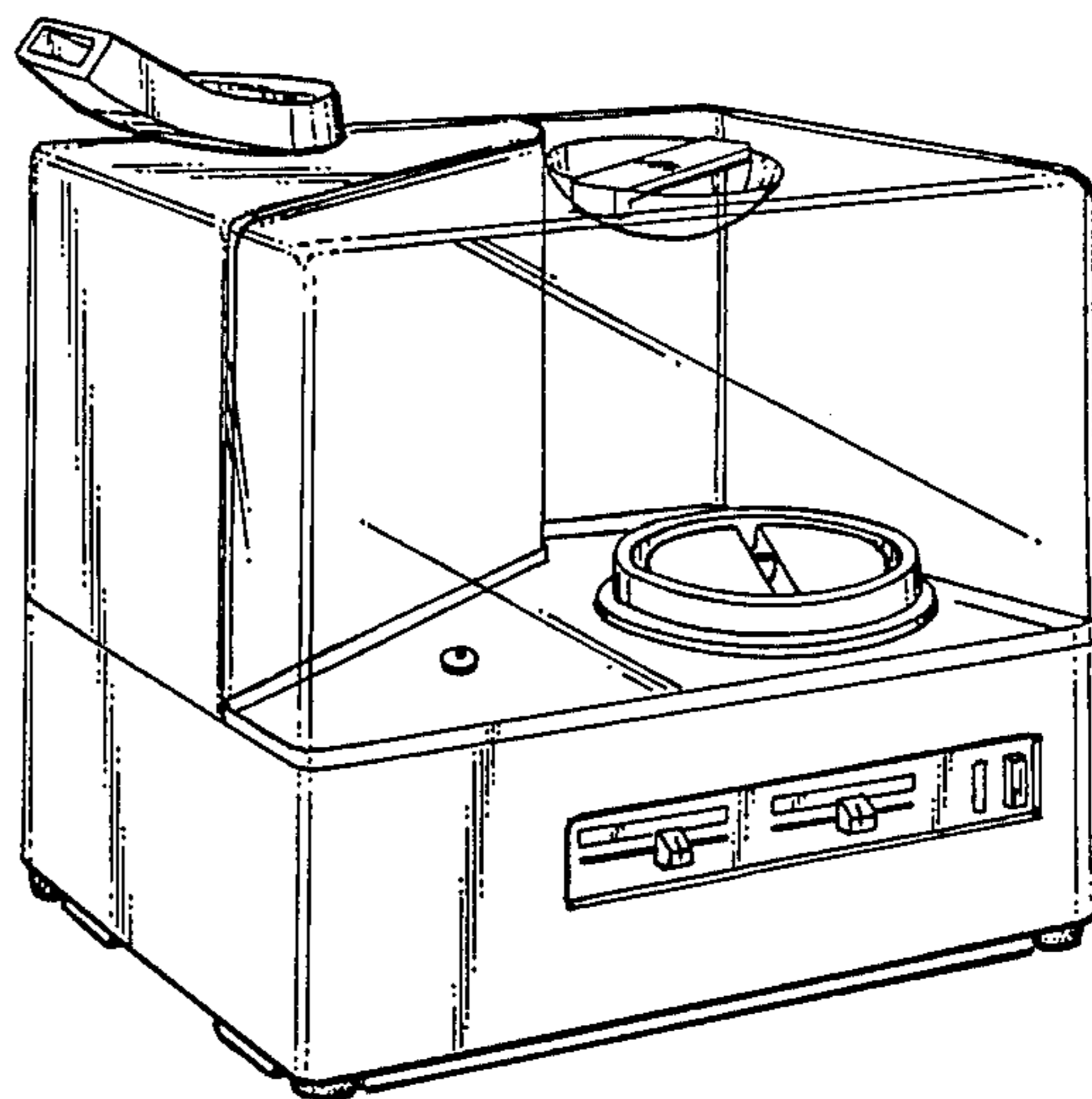

FIG. 1.

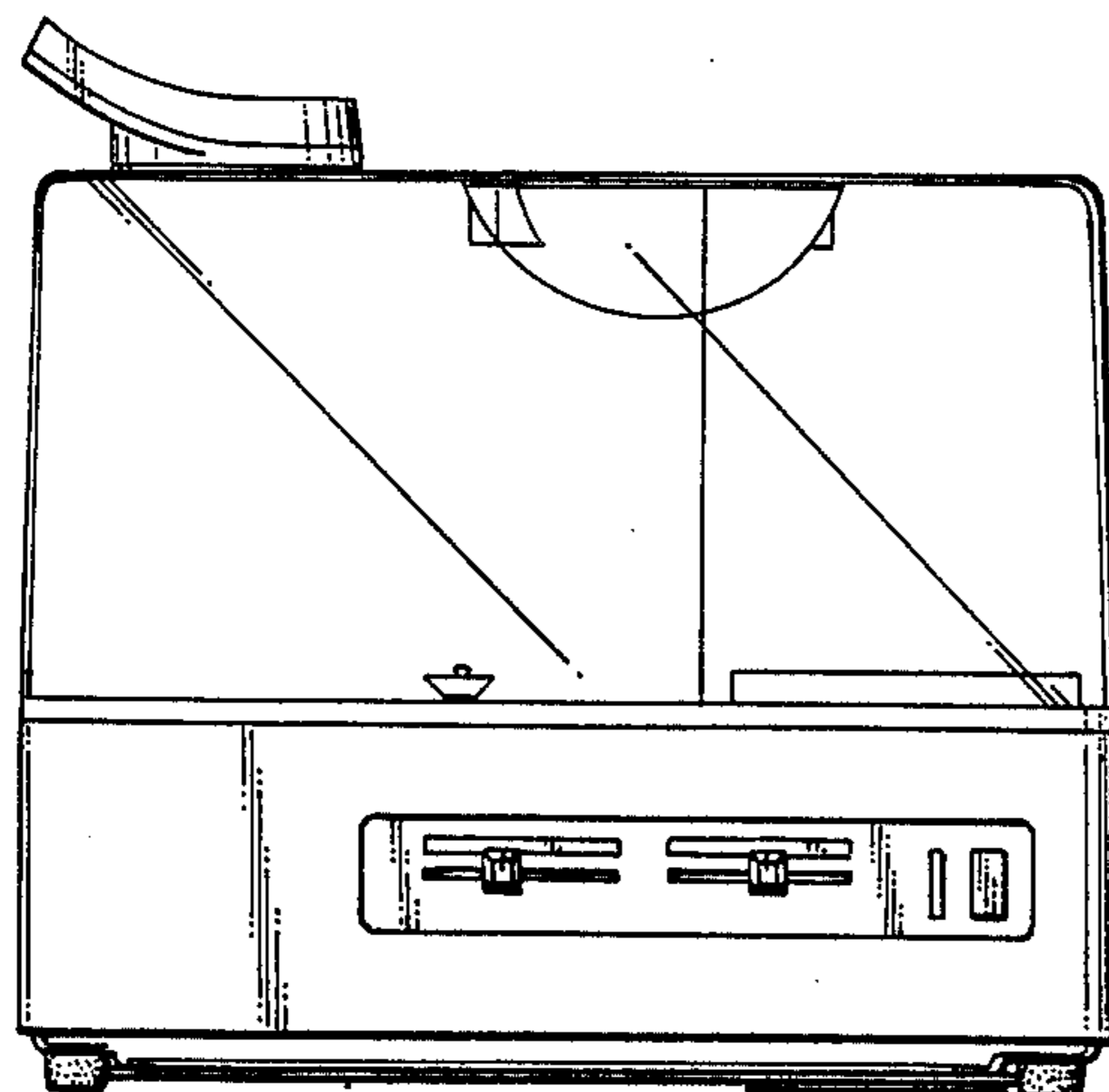

FIG. 3.

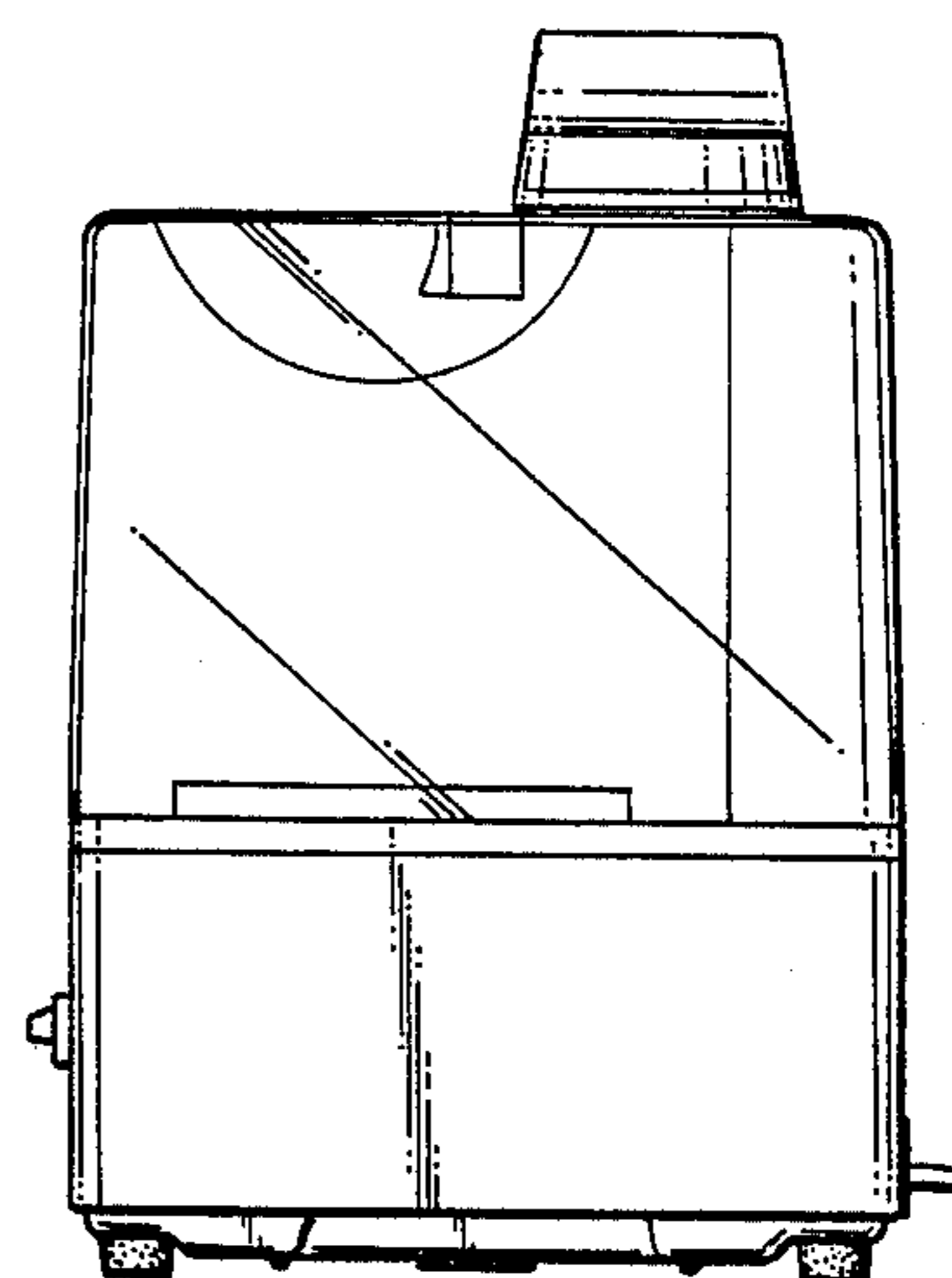

FIG. 4.

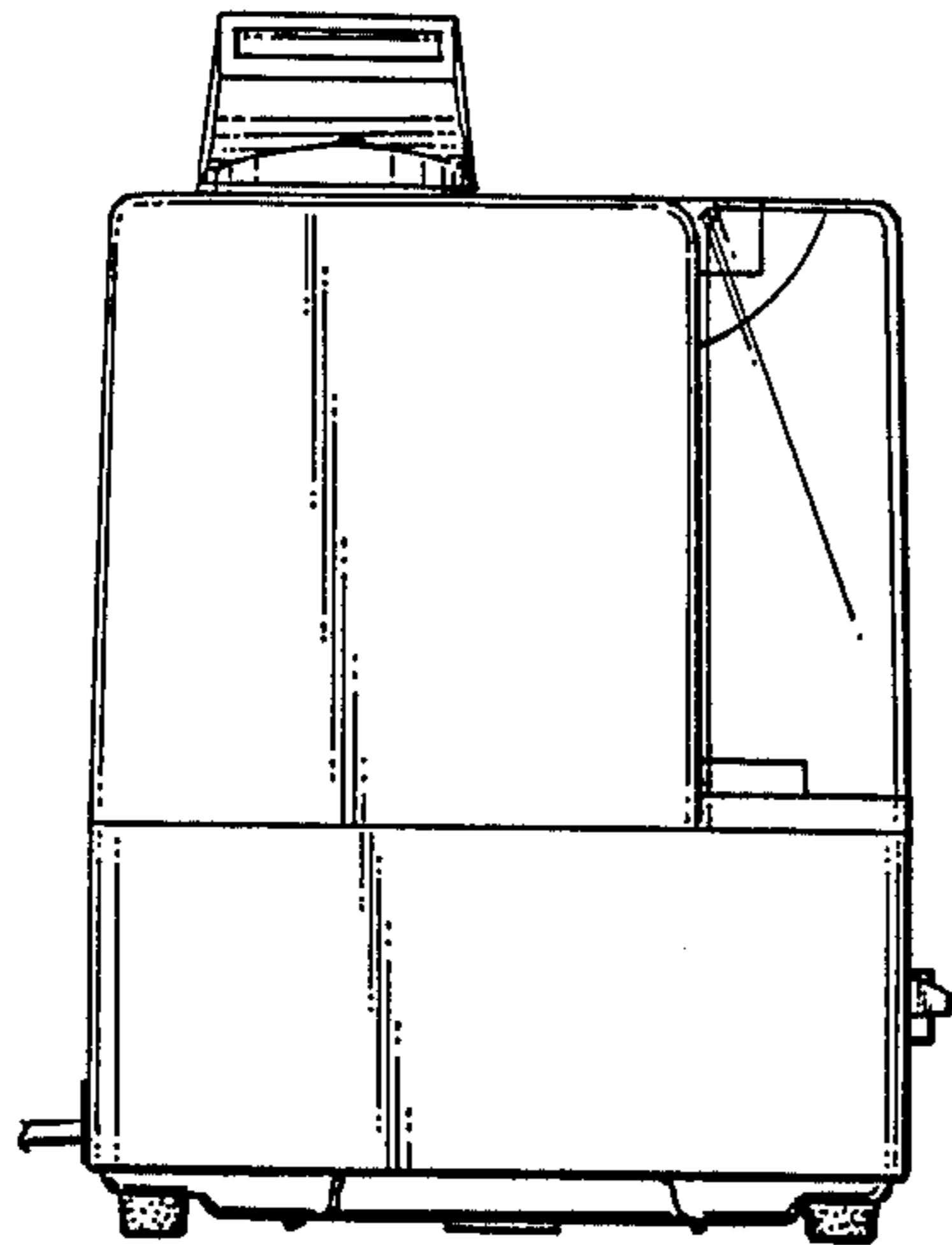

FIG. 5.

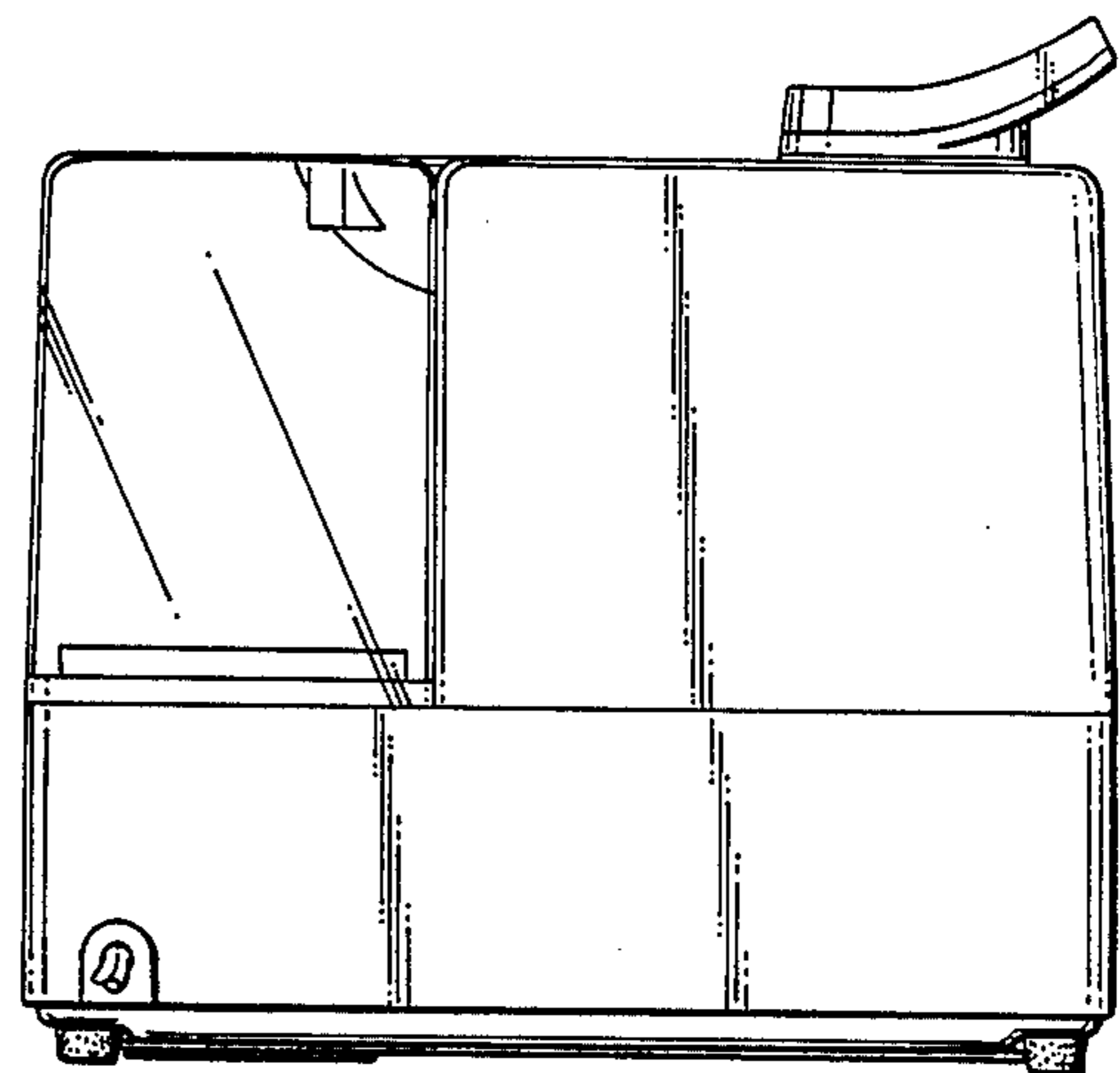

FIG. 6.

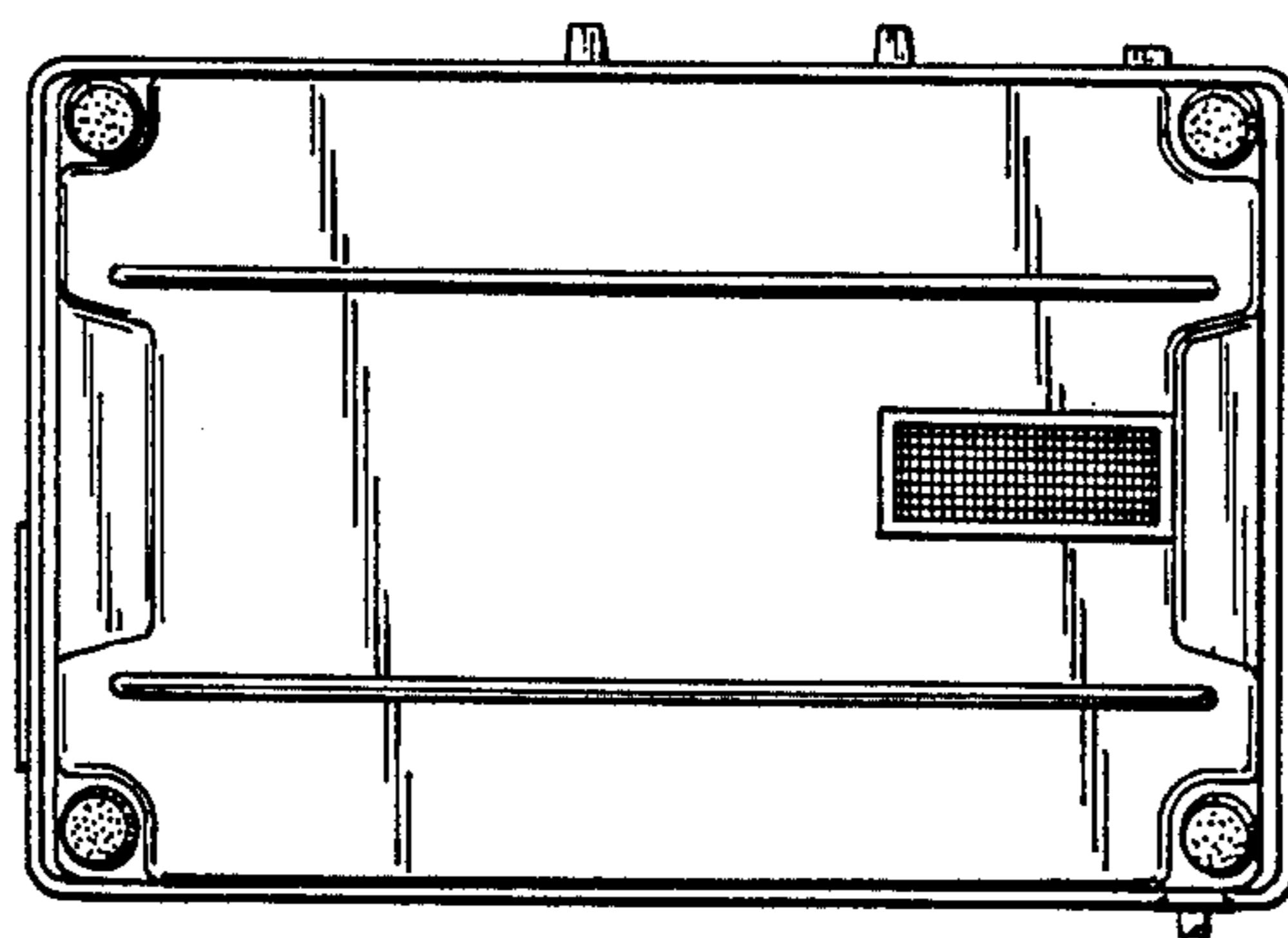

FIG. 7.