

[54] DEVELOPING DEVICE FOR ELECTROPHOTOGRAPHIC COPIER

[75] Inventor: Nobuo Masaki, Kawasaki, Japan

[73] Assignee: Canon Kabushiki Kaisha, Tokyo, Japan

[**] Term: 14 Years

[21] Appl. No.: 850,912

[22] Filed: Apr. 8, 1986

[30] Foreign Application Priority Data

Oct. 12, 1985 [JP] Japan 60-42850

[52] U.S. Cl. D16/32

[58] Field of Search D16/27-32; 355/3 R, 3 DD, 3 DR, 11, 14 R, 14 D

[56] References Cited

U.S. PATENT DOCUMENTS

D. 276,916 12/1984 Masaki D16/32

D. 286,297 10/1986 Clowe D16/32
D. 286,541 11/1986 Tarahashi D16/32
D. 287,023 12/1986 Masaki D16/32
4,530,588 7/1985 Kimura 355/3 DD X
4,657,369 4/1987 Takeuchi 355/3 DD X

Primary Examiner—Nelson C. Holtje
Attorney, Agent, or Firm—Fitzpatrick, Cella, Harper & Scinto

[57] CLAIM

The ornamental design for a developing device for electrophotographic copier, as shown and described.

DESCRIPTION

FIG. 1 is a front view of a developing device for electrophotographic copier;
FIG. 2 is a rear view thereof;
FIG. 3 is a top plan view thereof;
FIG. 4 is a bottom plan view thereof;
FIG. 5 is a left side elevational view thereof;
FIG. 6 is a right side elevational view thereof;
FIG. 7 is a top and right front perspective view thereof.

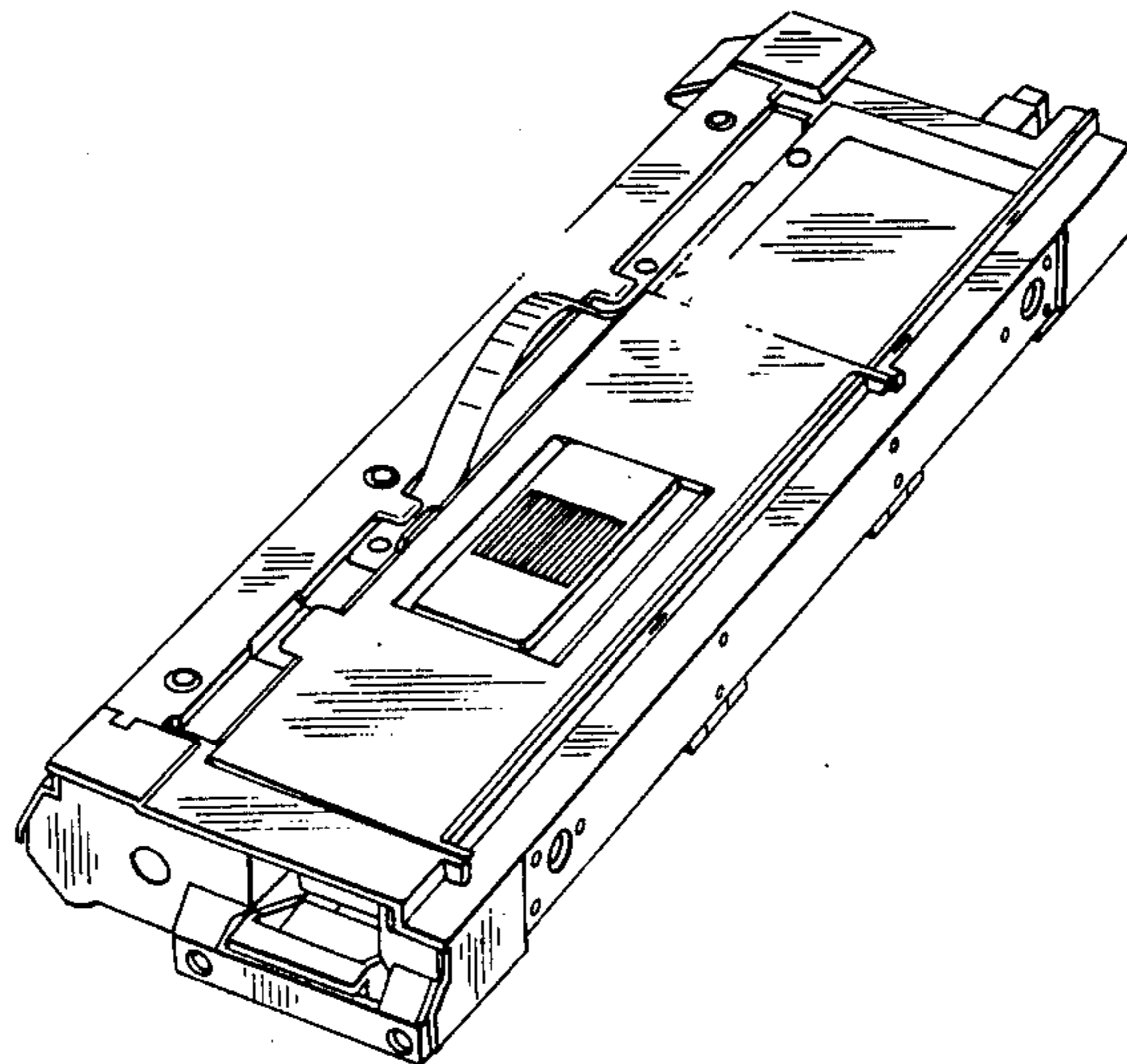

FIG. 1

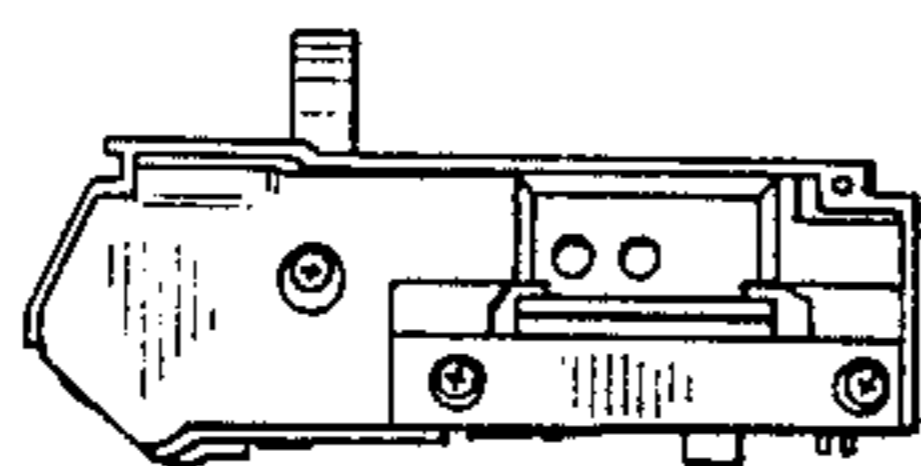

FIG. 2

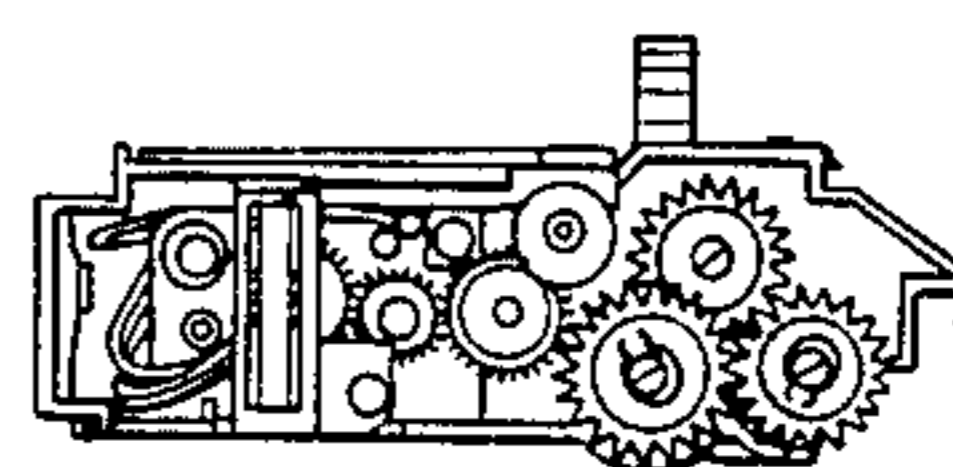

FIG. 3

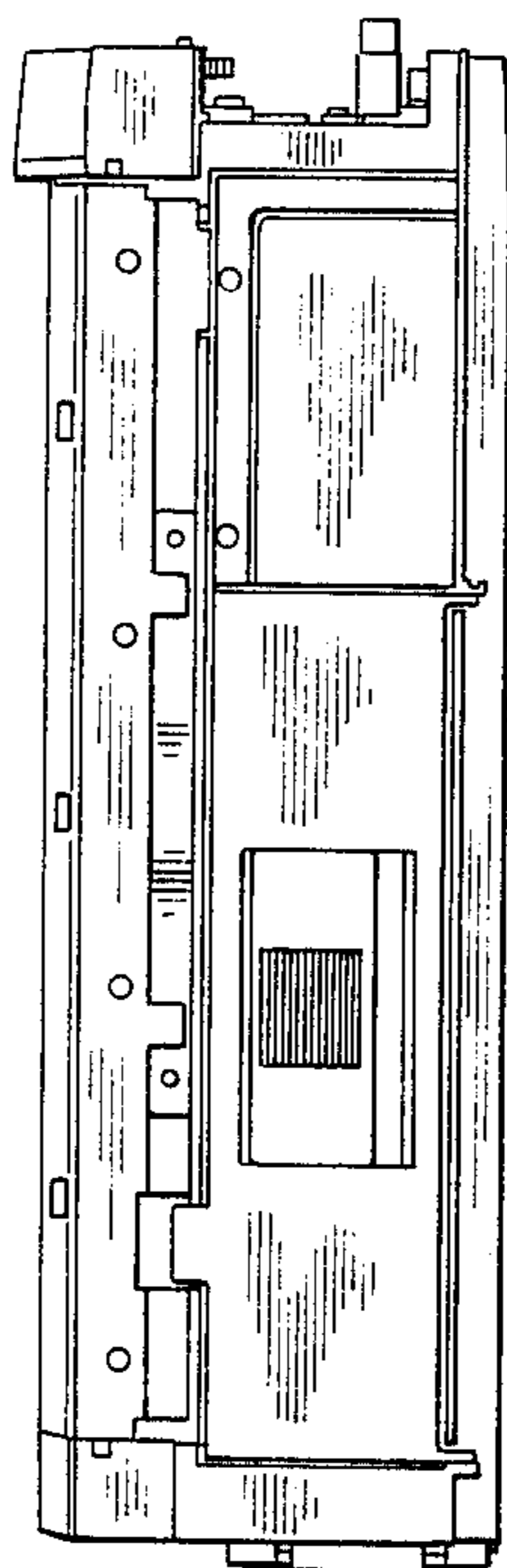

FIG. 4

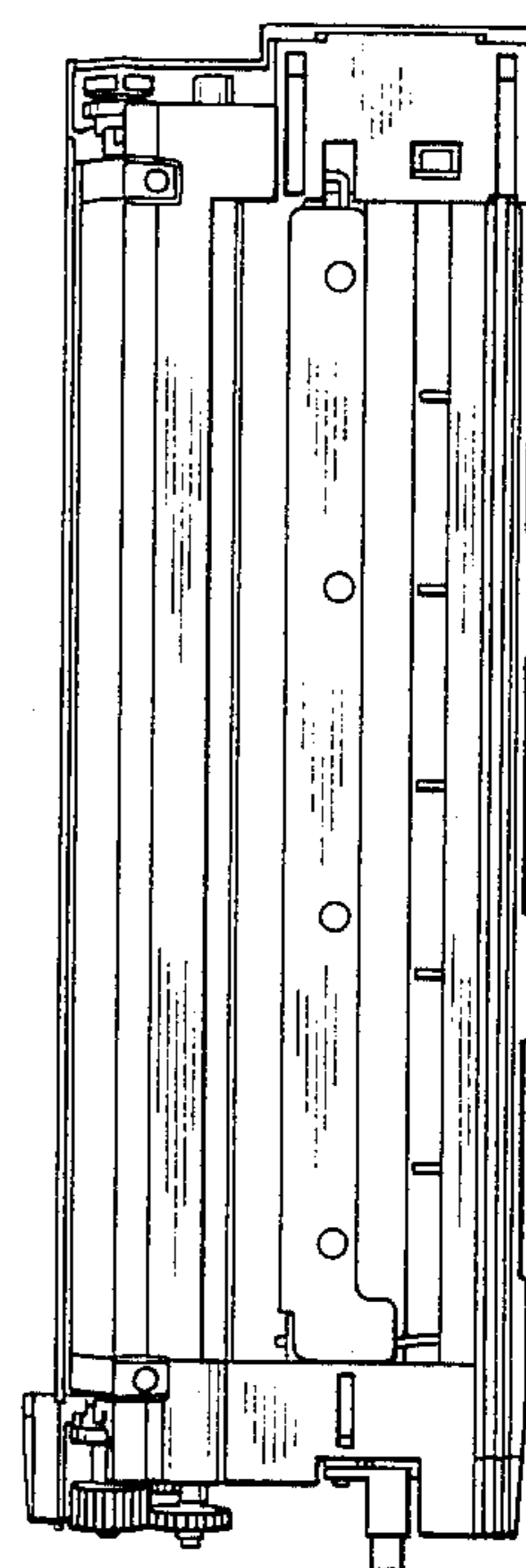

FIG. 5

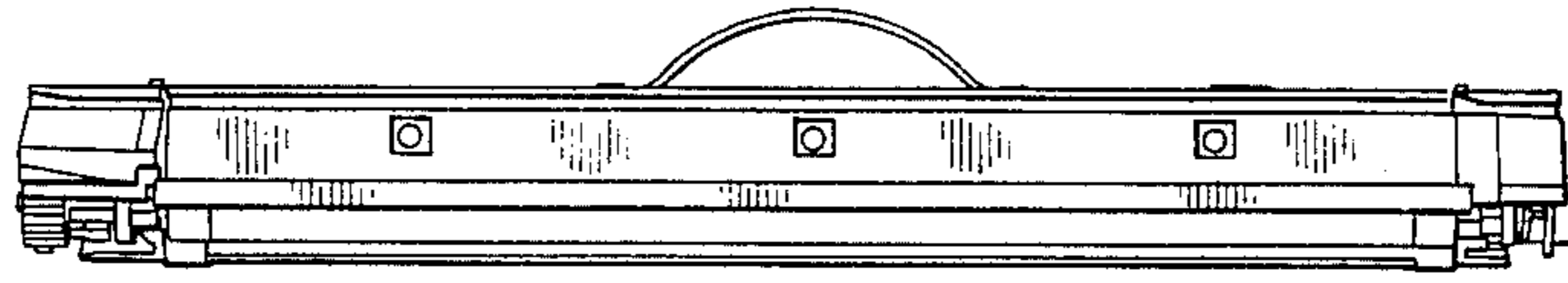

FIG. 6

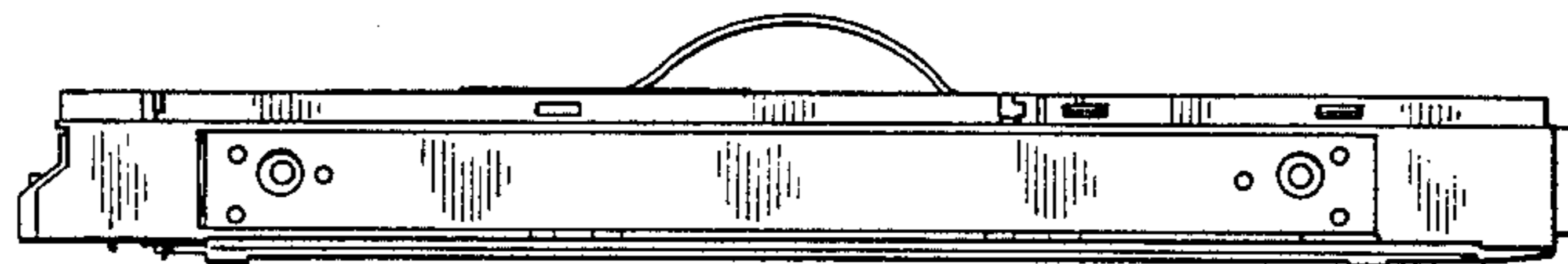

FIG. 7

