

[54] DEVELOPING DEVICE FOR ELECTROPHOTOGRAPHIC COPIER

[75] Inventors: Nobuo Masaki, Kawasaki; Naoki Tashiro, Tokyo, both of Japan

[73] Assignee: Canon Kabushiki Kaisha, Tokyo, Japan

[\*\*] Term: 14 Years

[21] Appl. No.: 819,308

[22] Filed: Jan. 16, 1986

[30] Foreign Application Priority Data

Jul. 19, 1985 [JP] Japan ..... 60-30946

[52] U.S. Cl. .... D16/32

[58] Field of Search ..... D16/27-32; 355/3 R, 3 DD, 3 DR, 11, 14 R, 14 D

[56] References Cited

U.S. PATENT DOCUMENTS

D. 276,916 12/1984 Masaki ..... D16/32

D. 286,542 11/1986 Saito ..... D16/32  
D. 287,023 12/1986 Masaki ..... D16/32  
4,523,834 6/1985 Pecda ..... 355/3 DD  
4,583,843 4/1986 Ohata ..... 355/3 DD  
4,695,153 9/1987 Matsushita ..... 355/3 DD

Primary Examiner—Nelson C. Holtje  
Attorney, Agent, or Firm—Fitzpatrick, Cella, Harper & Scinto

[57] CLAIM

The ornamental design for a developing device for electrophotographic copier as shown and described.

DESCRIPTION

FIG. 1 is a front elevational view of a developing device for electrophotographic copier showing our new design;

FIG. 2 is a rear elevational view thereof;

FIG. 3 is a top plan view thereof;

FIG. 4 is a bottom plan view thereof;

FIG. 5 is a left side elevational view thereof;

FIG. 6 is a right side elevational view thereof;

FIG. 7 is a top and right front perspective view thereof.

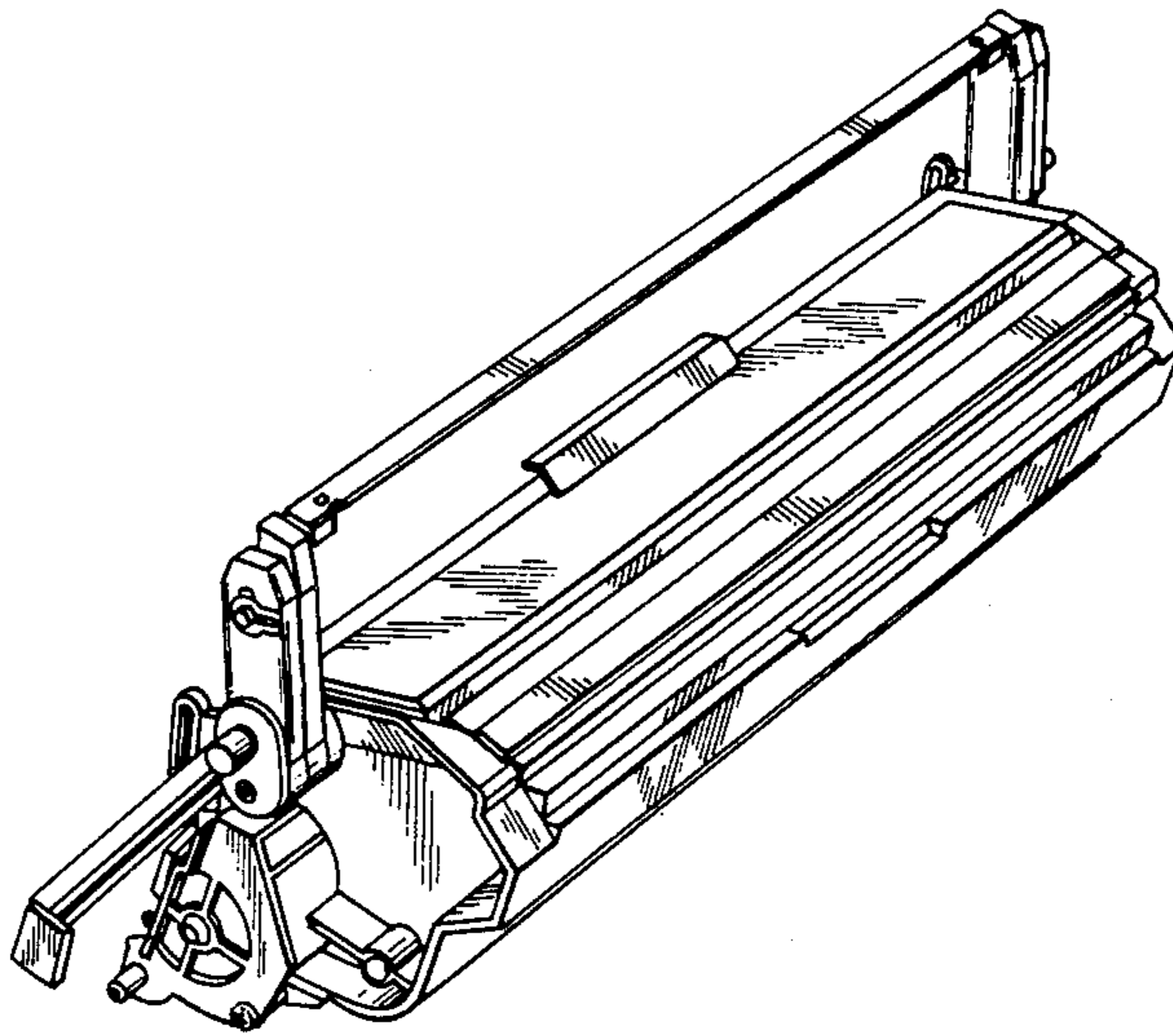

*FIG. 1*

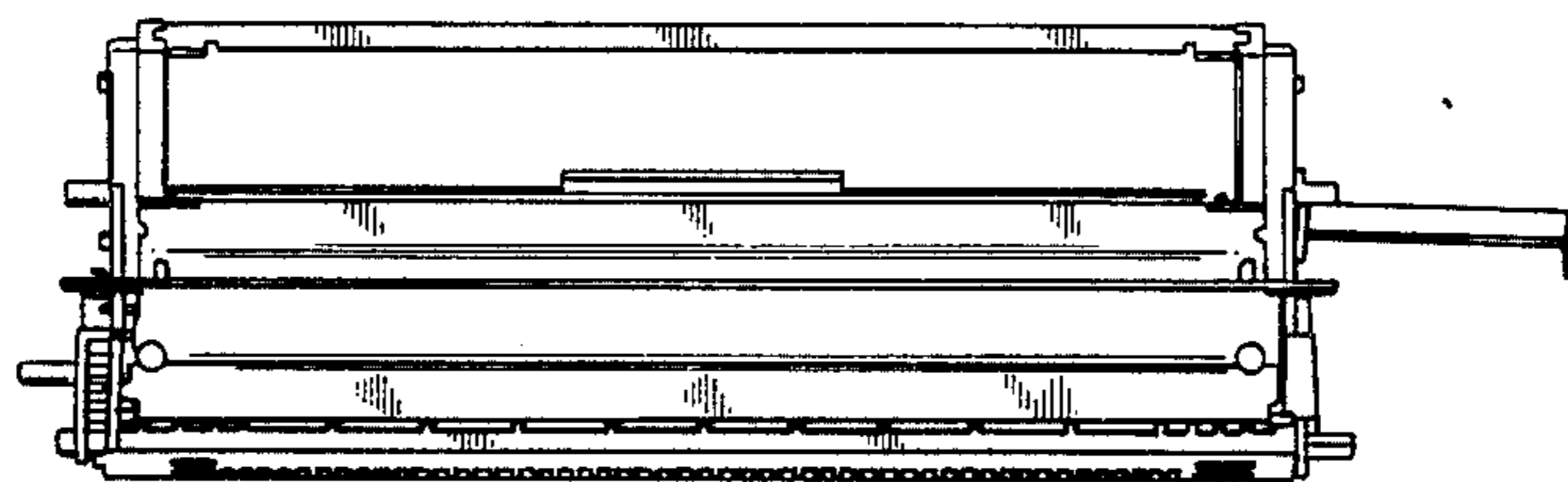

*FIG. 2*

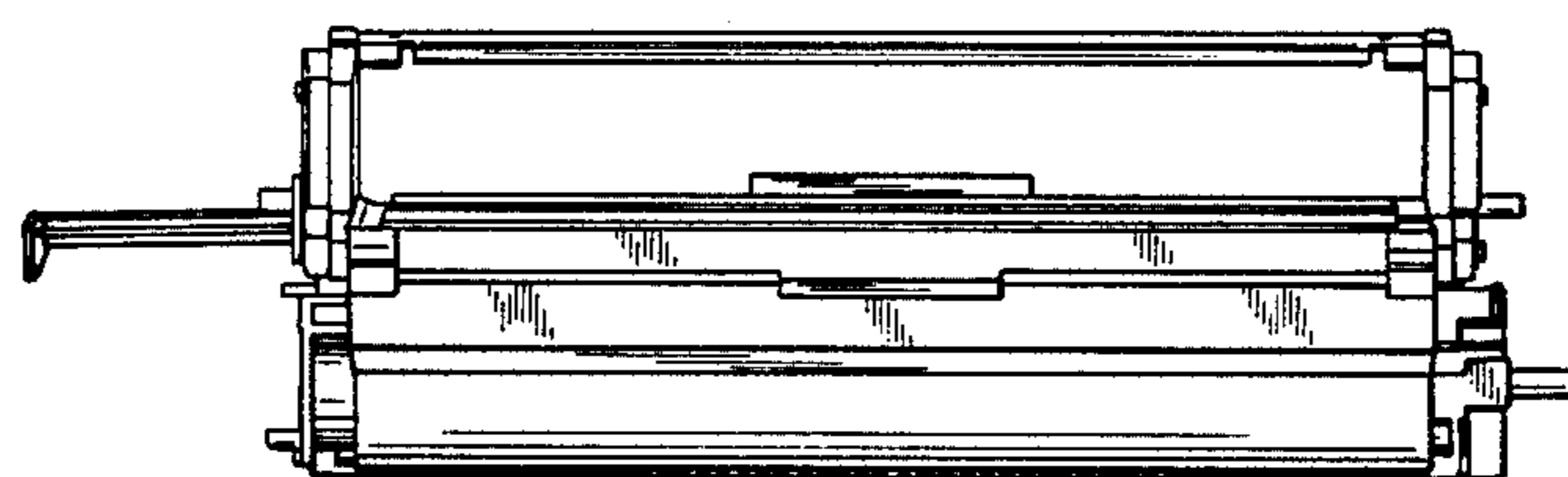

*FIG. 3*

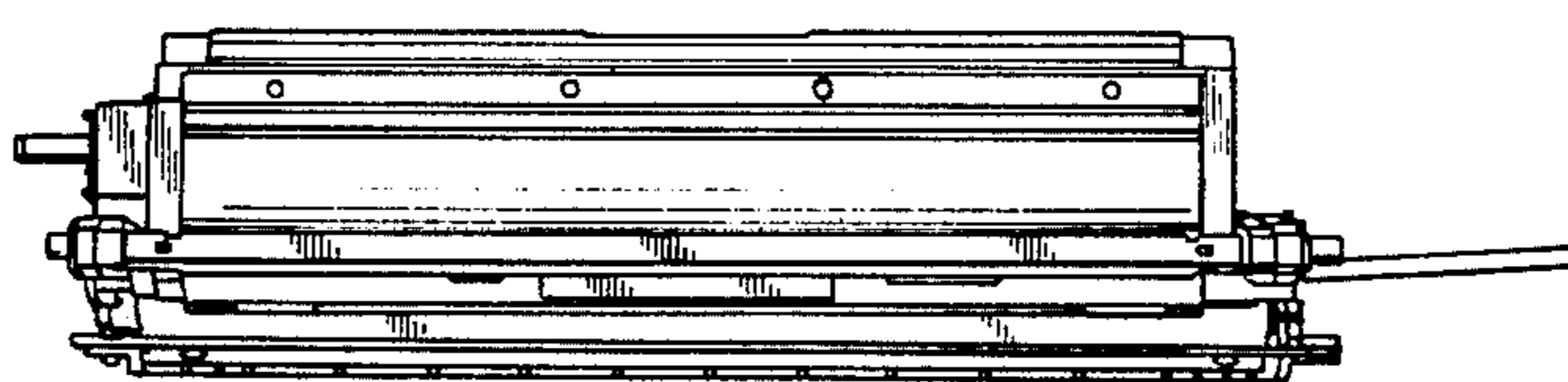

FIG. 4

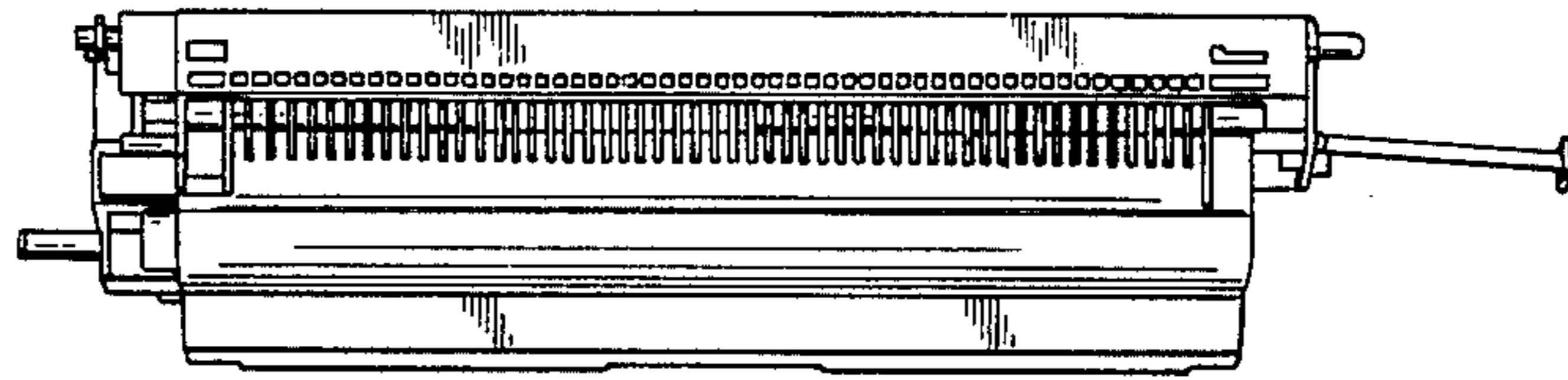

FIG. 5

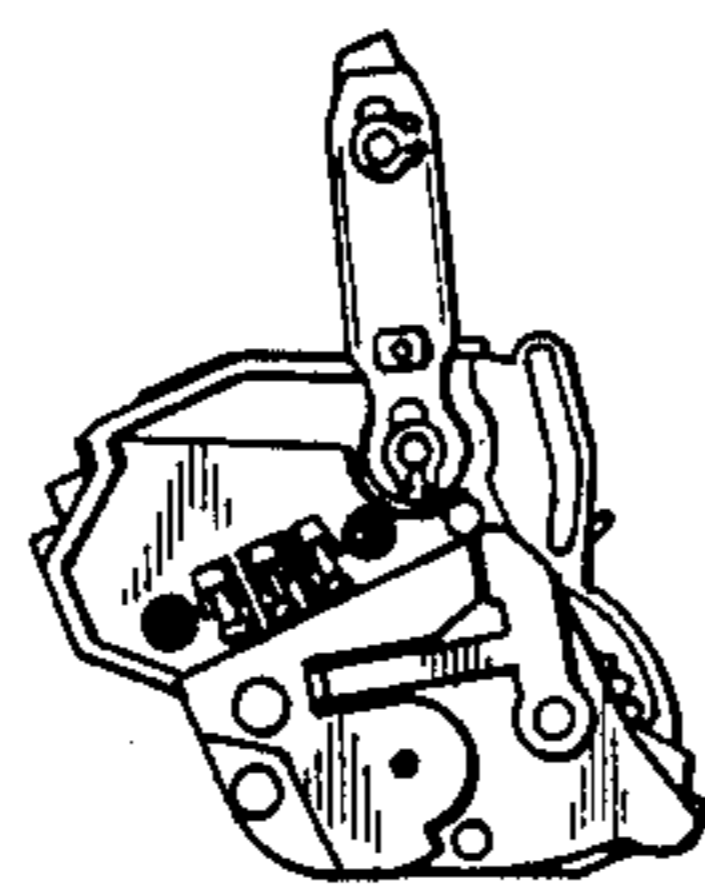

FIG. 6

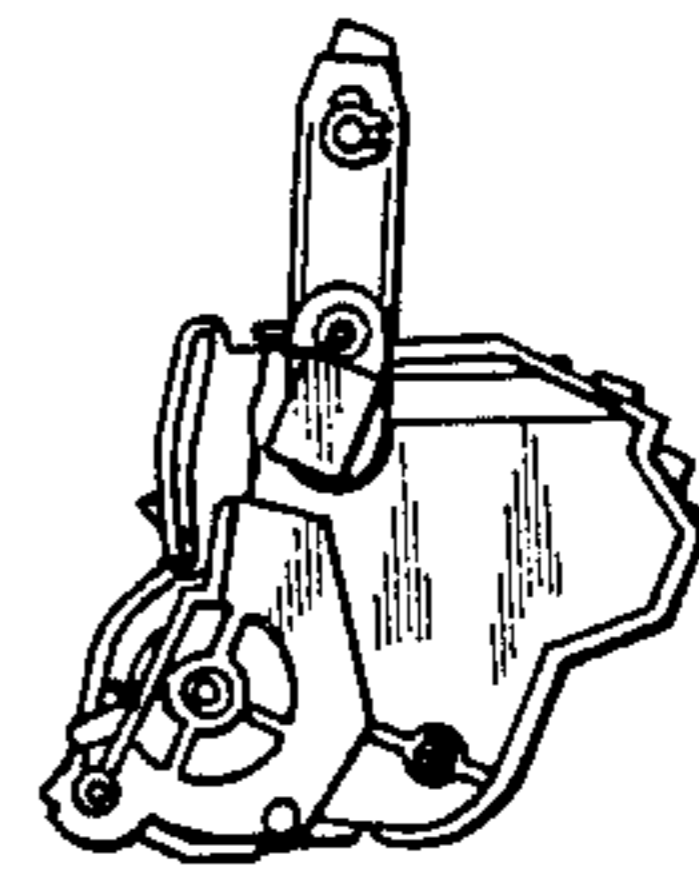

FIG. 7

