

[54] TELEVISION RECEIVER

[75] Inventors: **Hiroyuki Kogane**, Tokyo; **Yasushi Fujitani**, Hachiouji; **Tsukasa Ariyoshi**, Kokubunji; **Shigeki Gushiken**, Tokyo; **Toru Kiyota**, Tachikawa; **Ryuichiro Tanaka**, Kokubunji, all of Japan

[73] Assignee: **Hitachi, Ltd.**, Tokyo, Japan

[**] Term: **14 Years**

[21] Appl. No.: **877,511**

[22] Filed: **Jun. 23, 1986**

[30] Foreign Application Priority Data

Jan. 31, 1986 [JP] Japan 61-2943
[52] U.S. Cl. **D14/77**
[58] Field of Search D14/77, 79-83,
D14/99, 113; 358/254, 255; 312/7.2

[56] References Cited

U.S. PATENT DOCUMENTS

D. 265,651 8/1982 Brion D14/80

D. 281,778 12/1985 Gushiken et al. D14/80
D. 291,441 8/1987 Nishiyori et al. D14/77

OTHER PUBLICATIONS

Stereo Review, Dec. 1985, p. 17, middle right.
Video Review, Jan. 1986, p. 82, top right, Radio Shack Stereo T.V.

Primary Examiner—Bernard Ansher
Assistant Examiner—Theodore M. Shooman
Attorney, Agent, or Firm—Antonelli, Terry & Wands

[57] CLAIM

The ornamental design for television receiver, as shown and described.

DESCRIPTION

FIG. 1 is a top, front and right side perspective view of a television receiver showing our new design; FIG. 2 is a front elevational view thereof; FIG. 3 is a top plan view thereof; FIG. 4 is a right side elevational view thereof; FIG. 5 is a left side elevational view thereof; FIG. 6 is a rear elevational view thereof; and, FIG. 7 is a bottom plan view thereof.

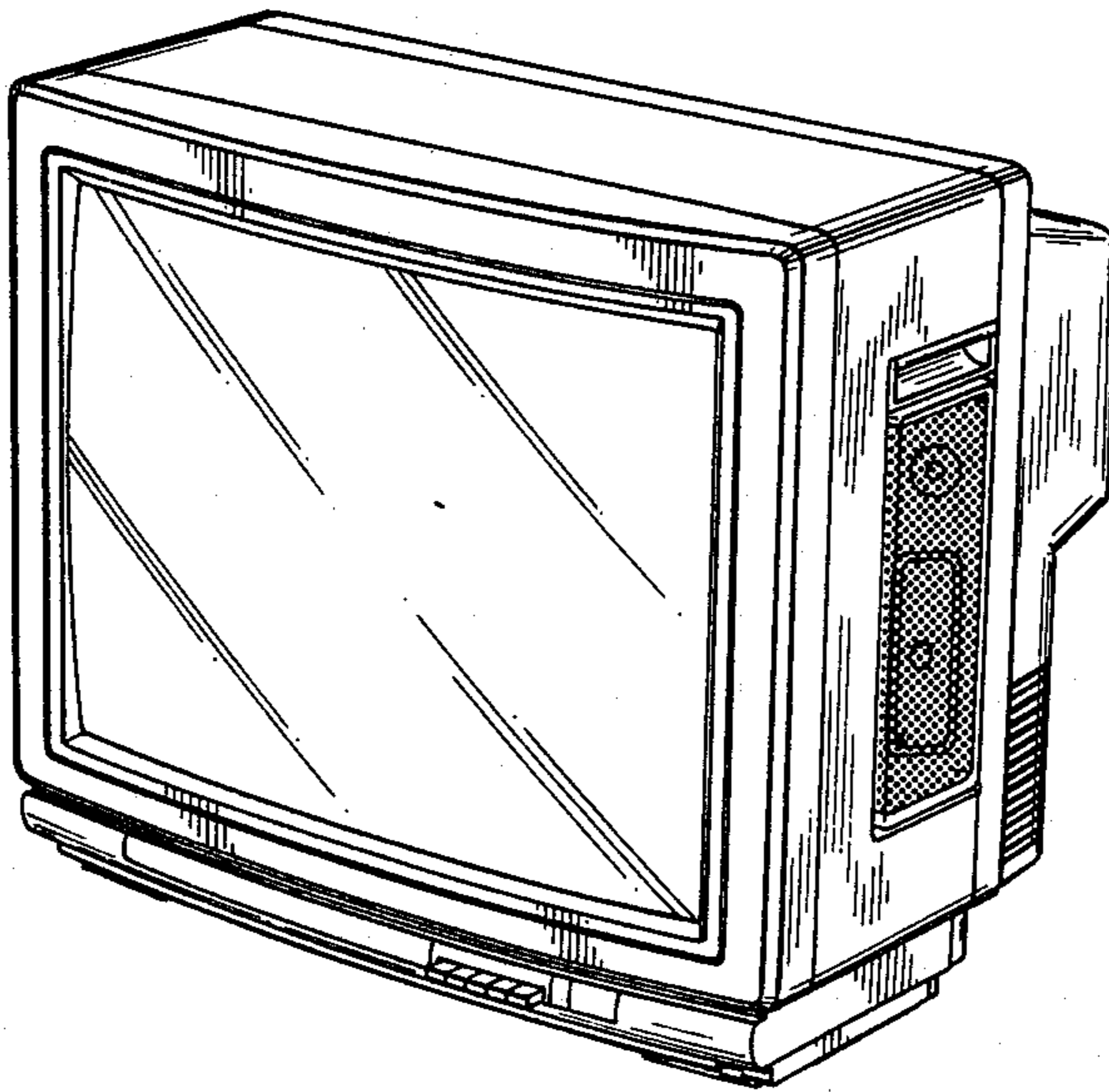

FIG. 1

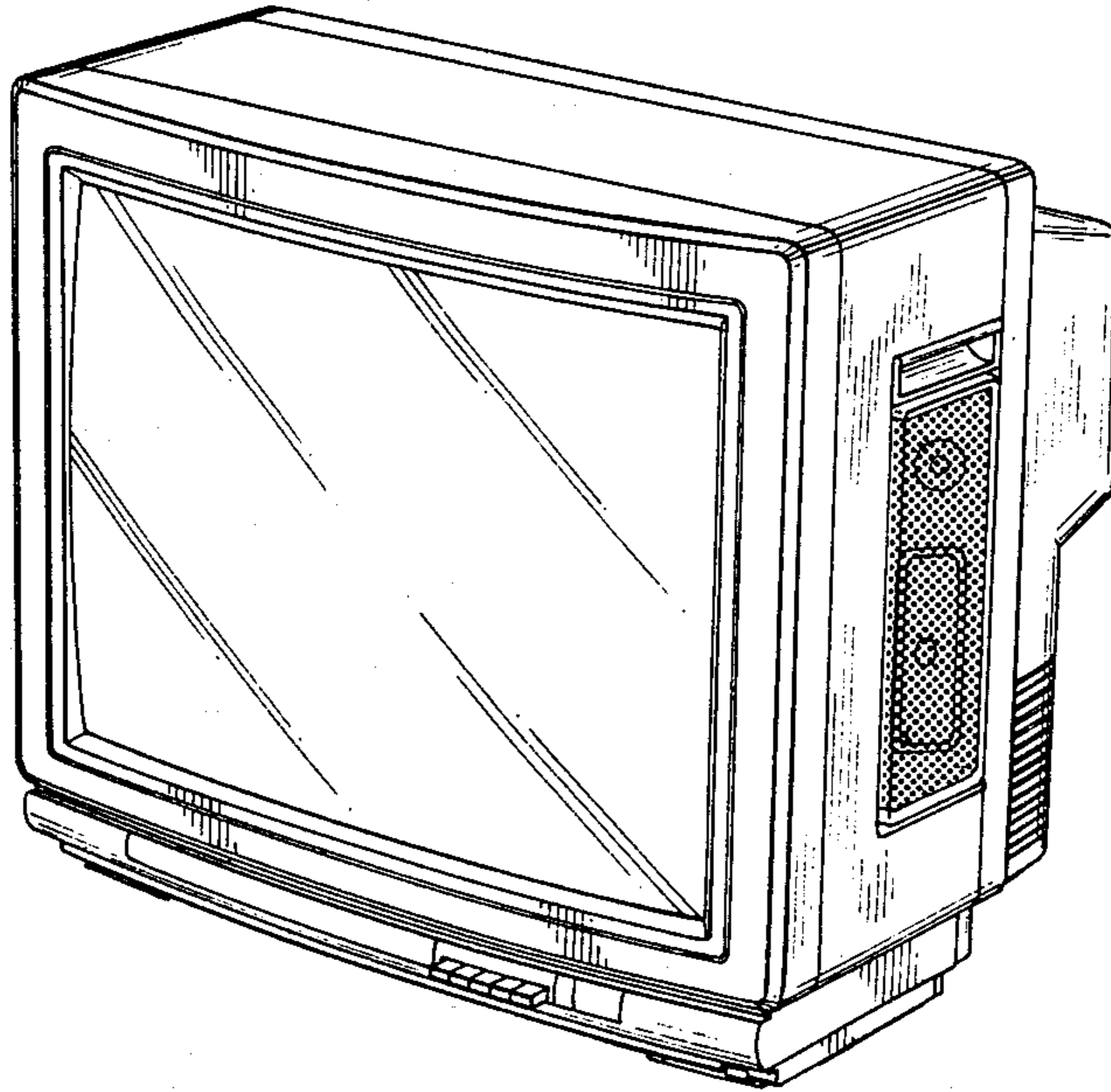

FIG. 2

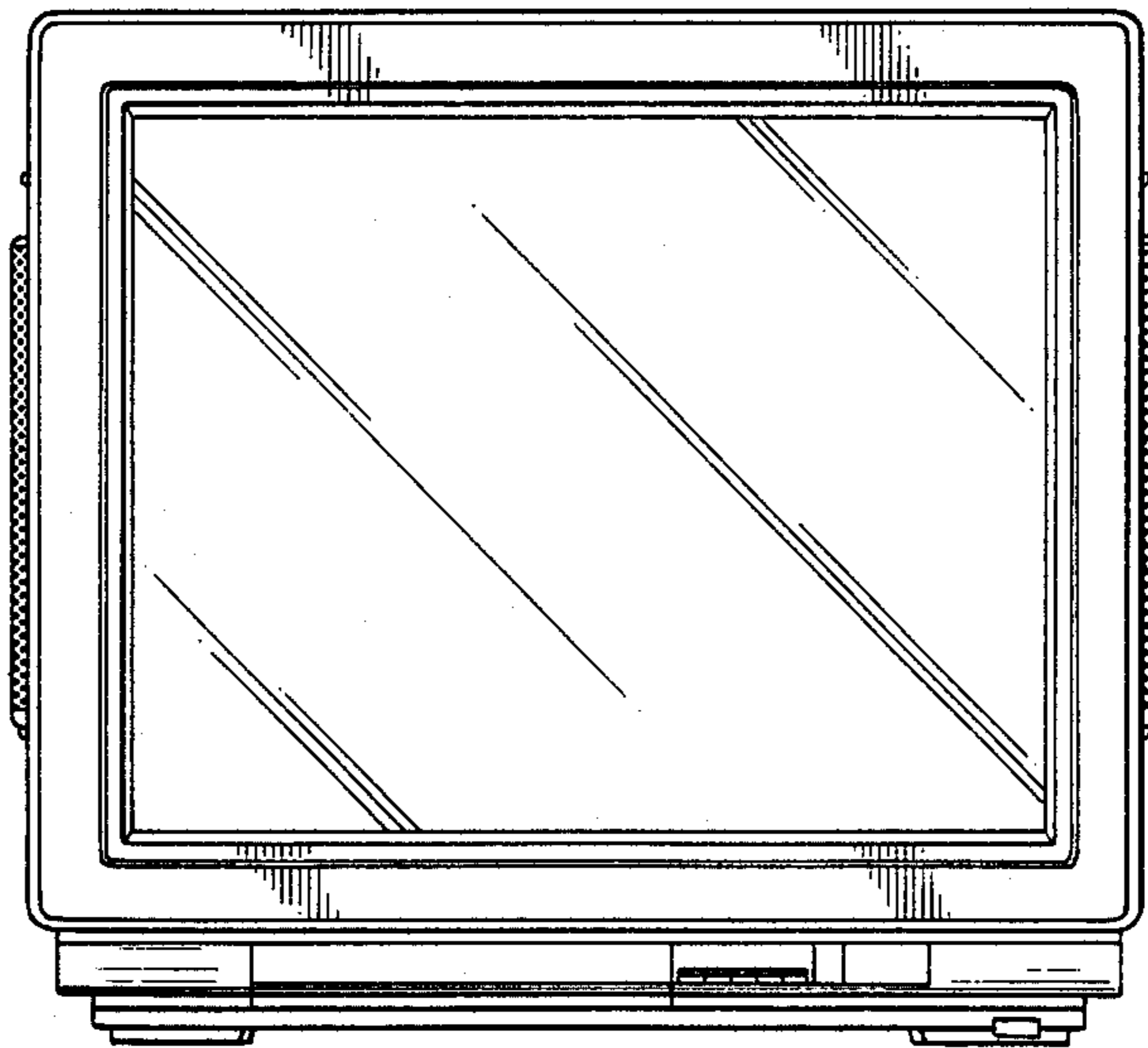

FIG. 3

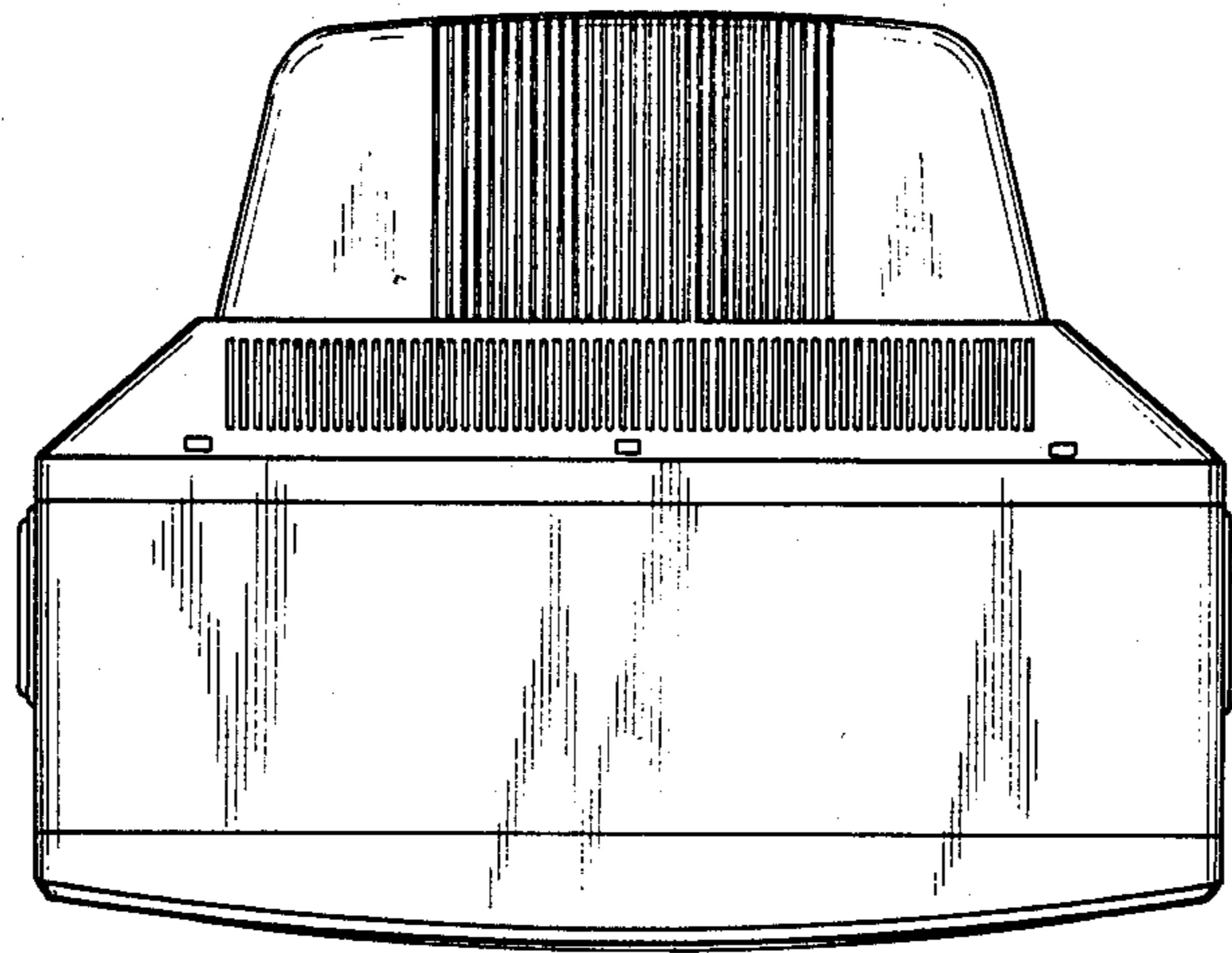

FIG. 4

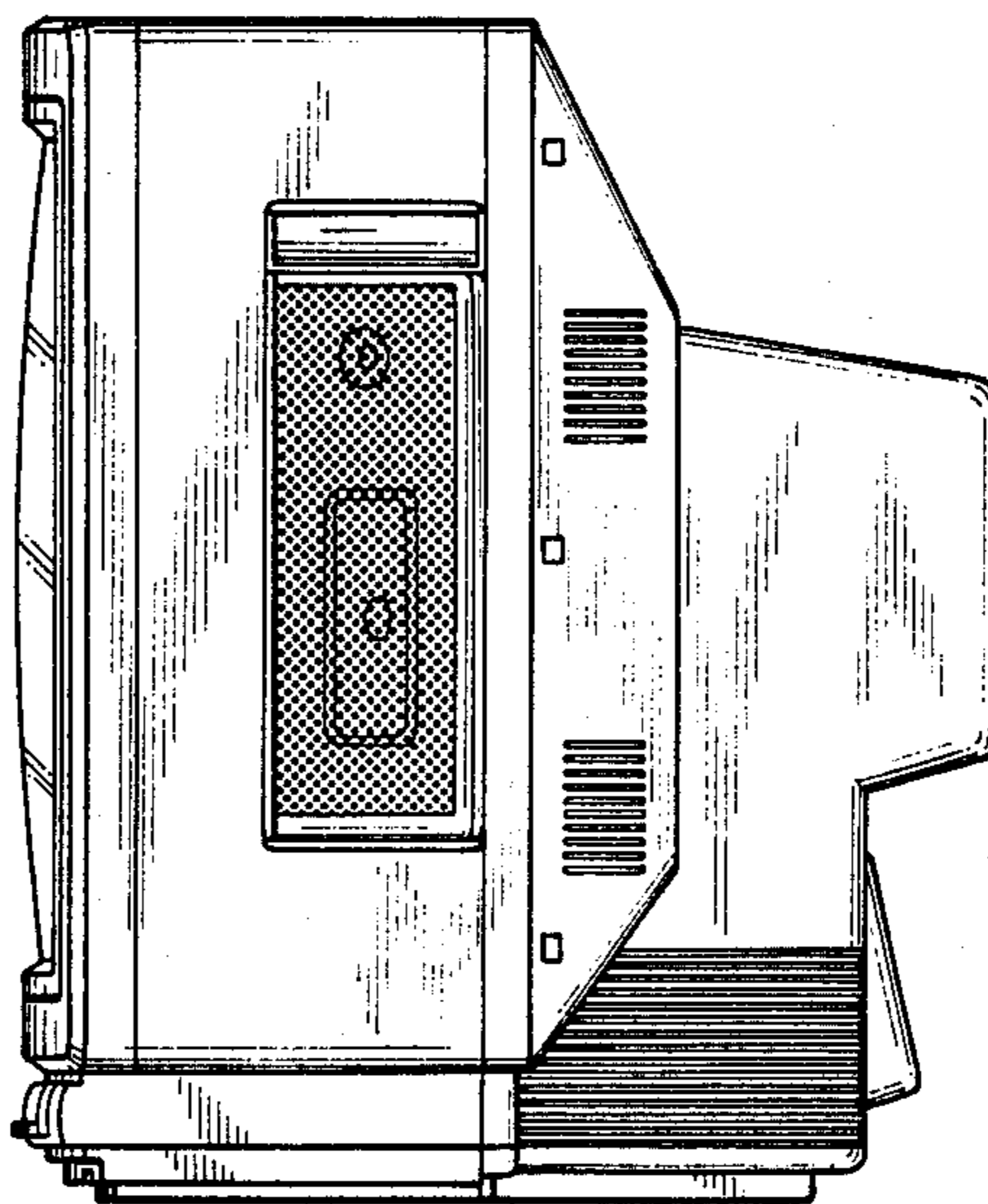

FIG. 5

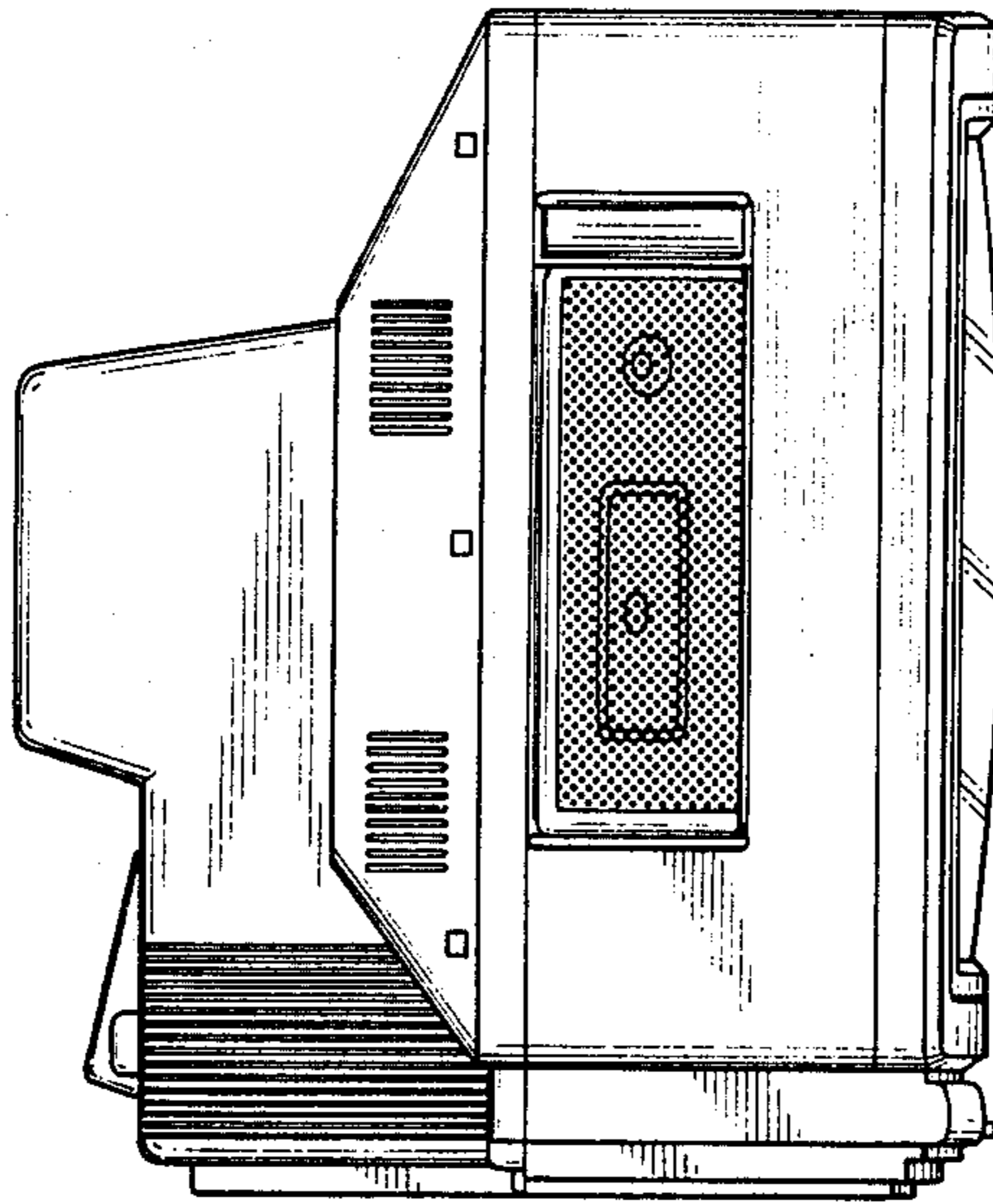

FIG. 6

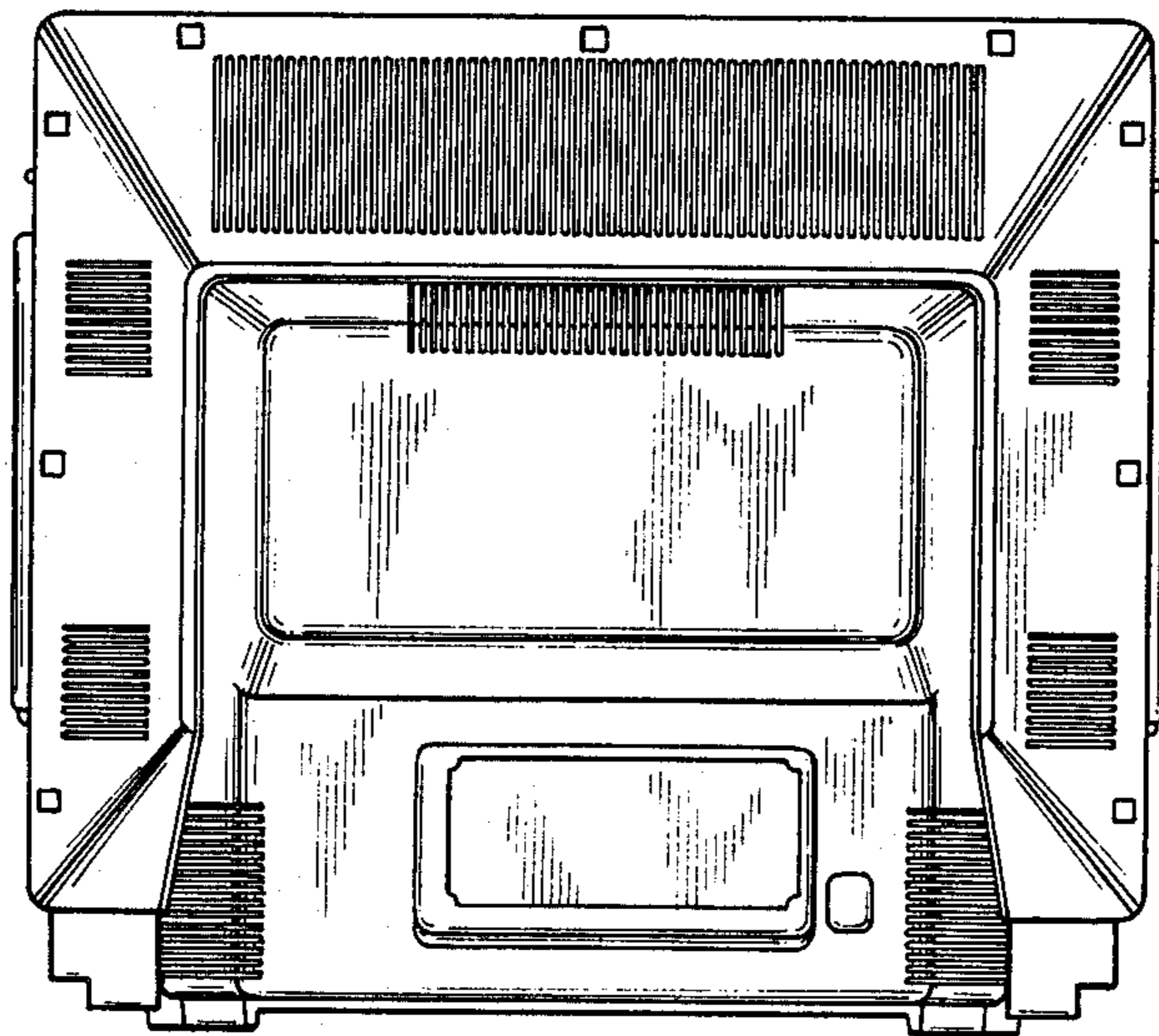

FIG. 7

