

- [54] SINK
- [75] Inventor: Christopher K. Downs, South Penrith, Australia
- [73] Assignee: McIlwraith Davey Pty. Ltd., Victoria, Australia
- [\*\*] Term: 14 Years
- [21] Appl. No.: 899,942
- [22] Filed: Aug. 25, 1986
- [30] Foreign Application Priority Data  
 Apr. 28, 1986 [AU] Australia ..... 5014/86
- [52] U.S. Cl. .... D23/290
- [58] Field of Search ..... D23/284-294,  
 D23/619, 639-642
- [56] References Cited  
 U.S. PATENT DOCUMENTS  
 D. 174,749 5/1955 Harris et al. .... D23/287  
 D. 193,464 8/1962 Hauser ..... D23/290  
 D. 198,305 6/1964 Graning, Jr. .... D23/290

- D. 203,802 2/1966 Graning, Jr. .... D23/290
- D. 206,048 10/1966 Armstrong ..... D23/290
- D. 224,533 8/1972 Hauser ..... D23/290
- D. 259,439 6/1981 Doman ..... D23/287
- 2,045,969 6/1936 Stanitz ..... 4/637
- 2,063,243 12/1936 Groeniger ..... 4/642
- 2,157,785 5/1939 Coordes ..... D23/287 X
- 2,273,606 2/1942 Webber ..... 4/637

Primary Examiner—James R. Largen  
Attorney, Agent, or Firm—Ladas & Parry

[57] CLAIM

The ornamental design for a sink, as shown

DESCRIPTION

FIG. 1 is a perspective view taken from the top, front and left side of a sink showing my new design; FIG. 2 is a top plan view thereof; FIG. 3 is a bottom plan view thereof; FIG. 4 is a front elevational view thereof; FIG. 5 is a left side elevational view thereof; FIG. 6 is a right side elevational view thereof; and FIG. 7 is a rear elevational view thereof.

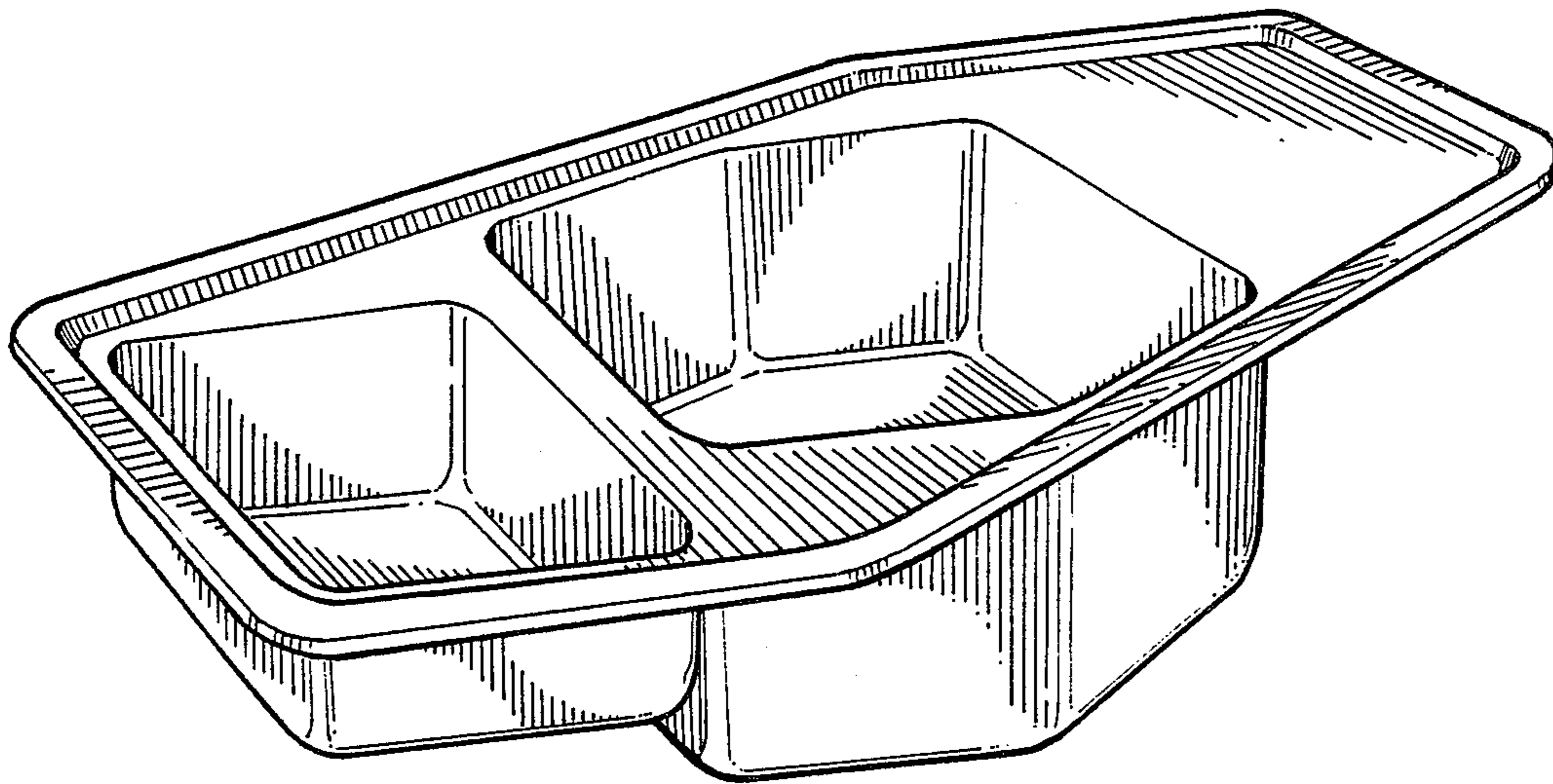

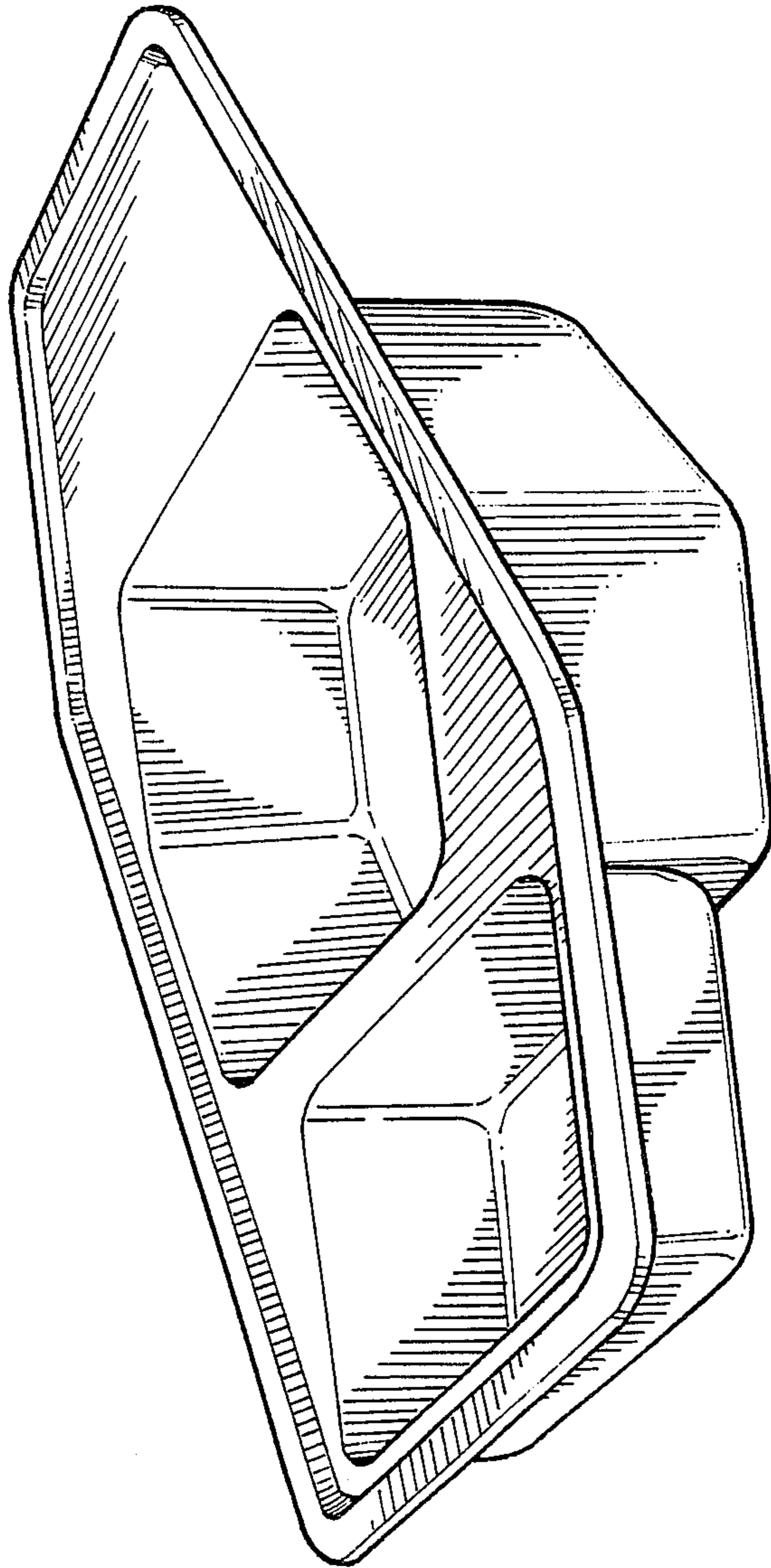

FIG. 1

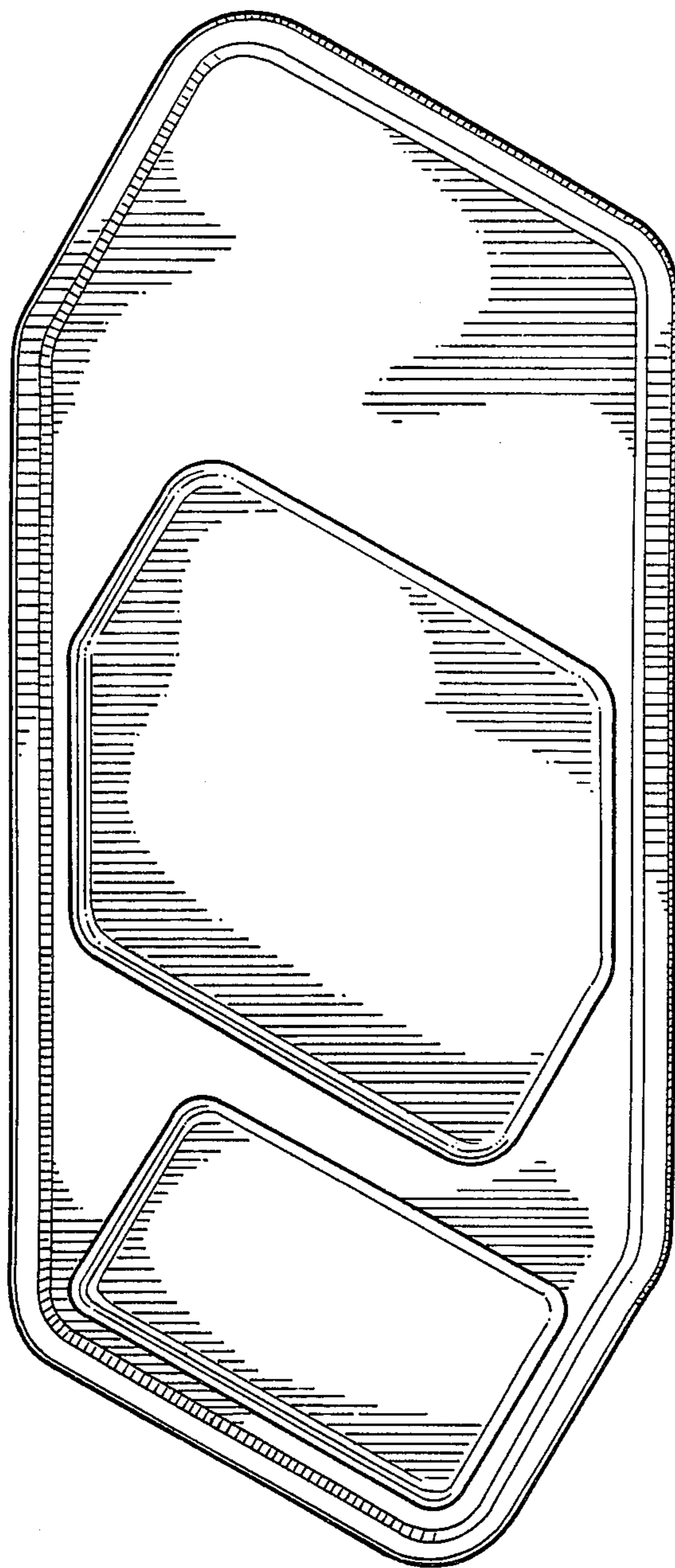

FIG. 2

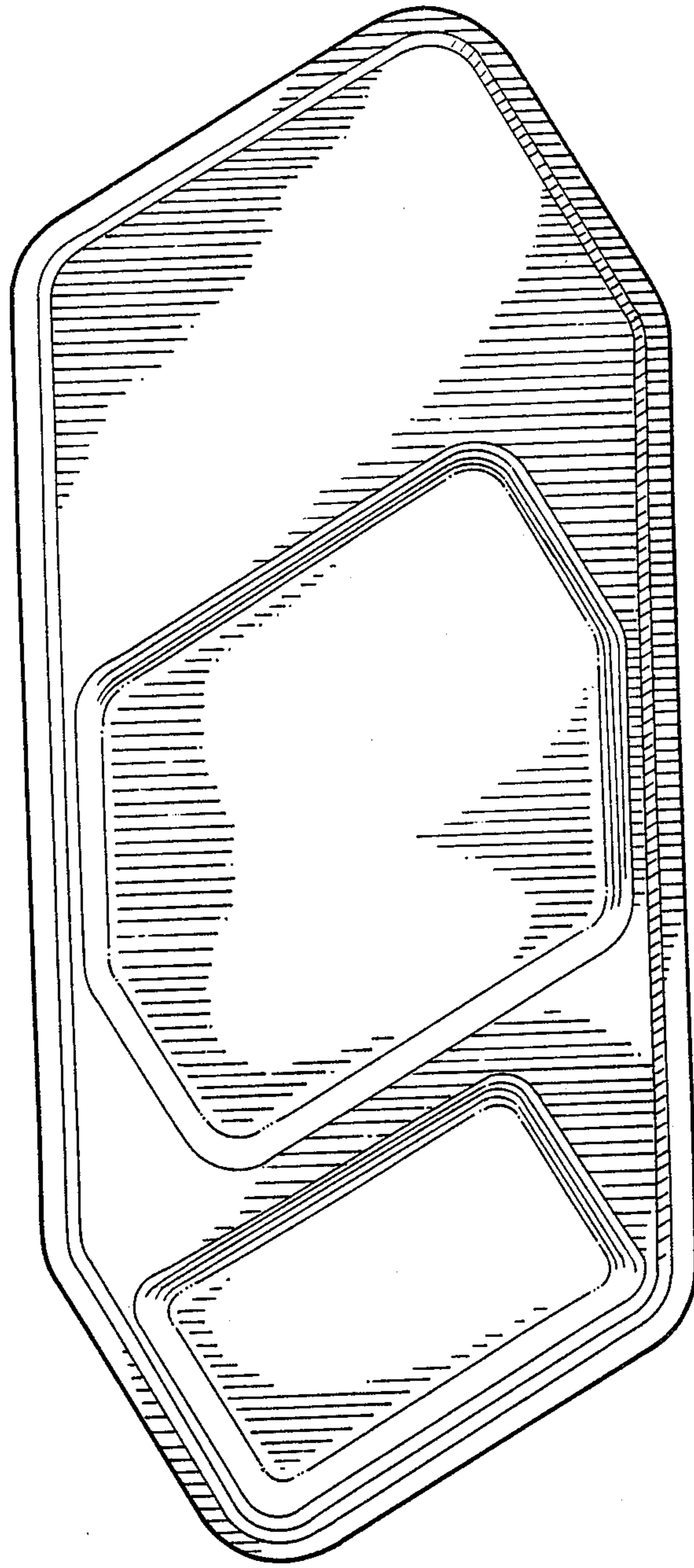

FIG. 3

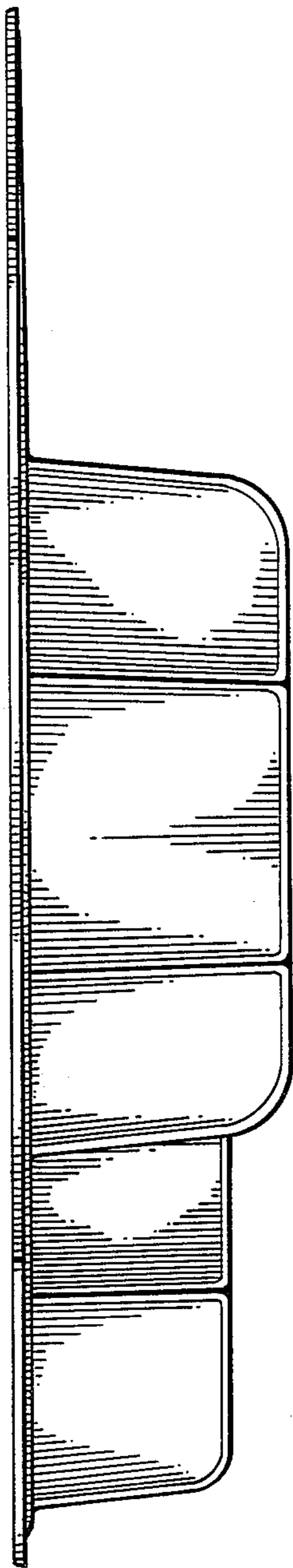

FIG. 4

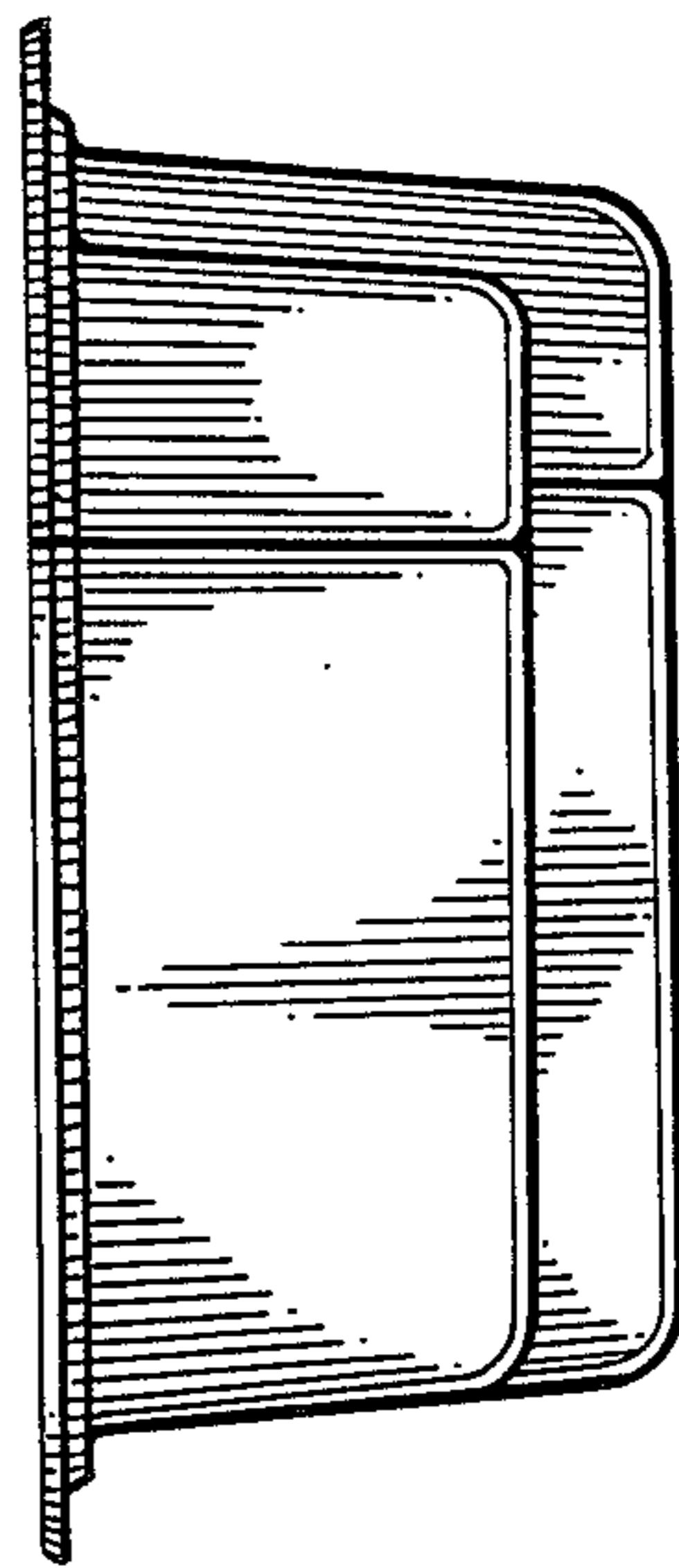

FIG. 5

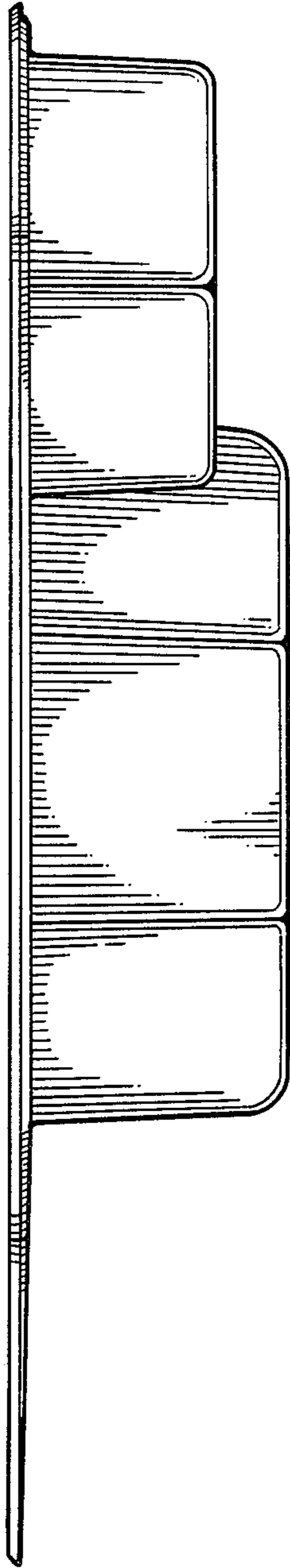

FIG. 7

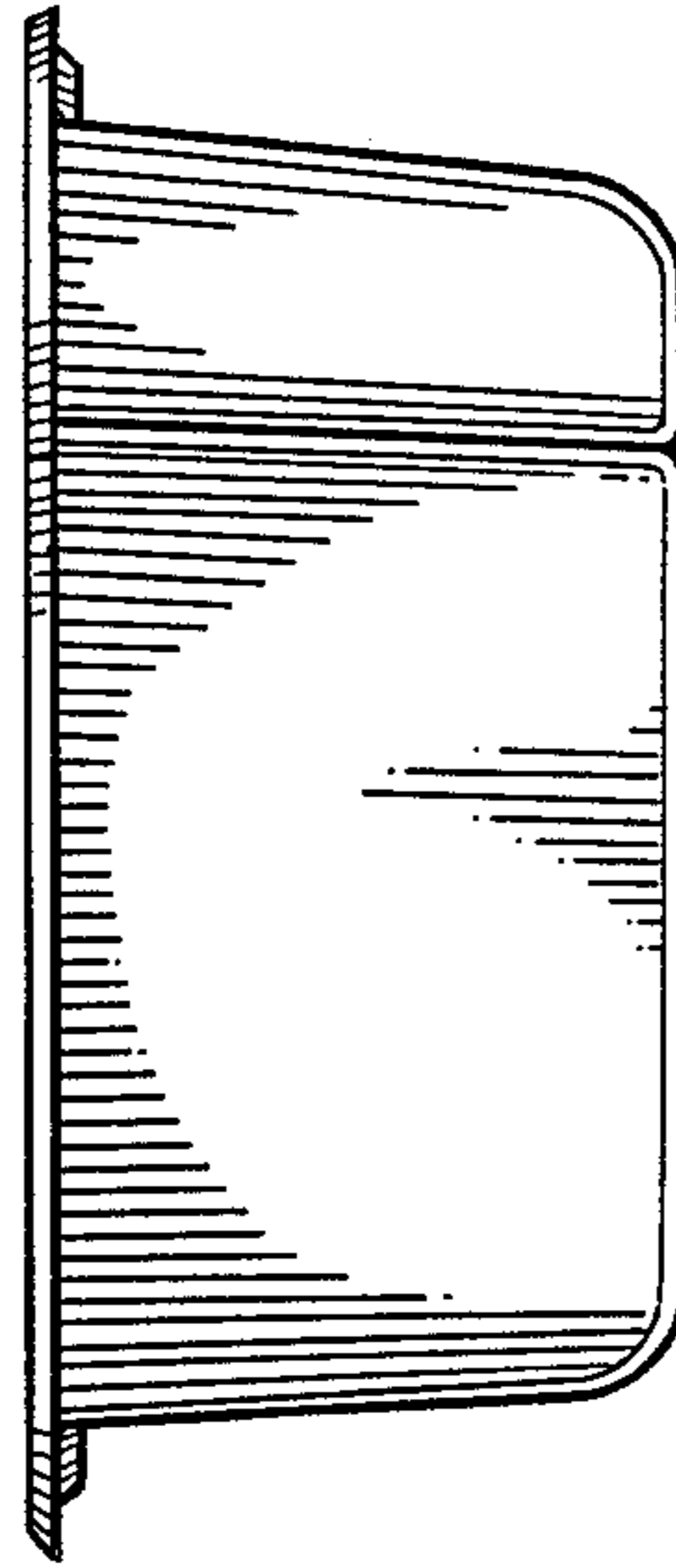

FIG. 6