

[54] **SCREW DRIVER**

[76] **Inventor:** Chung M. Chen, No. 45, Jih-Nan Road, Ta-Chia Tsen, Taichung Hsien, Taiwan

[**] **Term:** 14 Years

[21] **Appl. No.:** 638,508

[22] **Filed:** Aug. 7, 1984

[52] **U.S. Cl.** D8/85; 81/177.1

[58] **Field of Search** D8/82-87, D8/25, 107; 81/177.1, 177.5, 437, 438, 439, 60

[56] **References Cited**

U.S. PATENT DOCUMENTS

D. 159,482	8/1950	Garbs	D8/87
1,755,822	4/1930	Hobbs	81/177.1
2,656,865	10/1953	Bright	81/60
4,235,269	11/1980	Kraus	81/438

OTHER PUBLICATIONS

Hardware Age, May 4, 1961, p. 89, "Handi-Angler" Screw Driver by Vaco Products Co.

Primary Examiner—Susan J. Lucas

Assistant Examiner—Clare E. Heflin

[57] **CLAIM**

The ornamental design for a screw driver, as shown and described.

DESCRIPTION

FIG. 1 is a perspective view of the screw driver showing my new design;

FIG. 2 is a perspective view thereof with the driver bit shown in an alternate position;

FIG. 3 is a front elevational view thereof;

FIG. 4 is a top plan view thereof;

FIG. 5 is a bottom plan view thereof;

FIG. 6 is a side elevational view thereof.

The driver bit has been omitted from FIGS. 3-6 for convenience of illustration only.

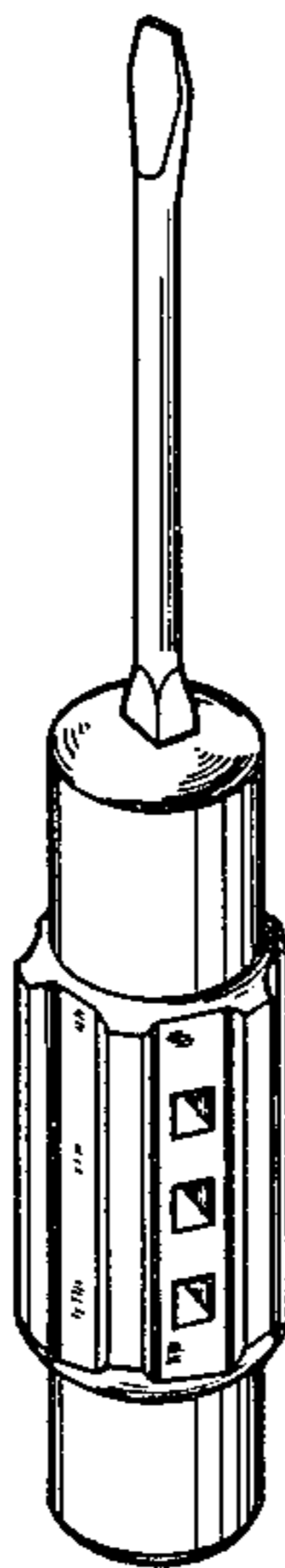

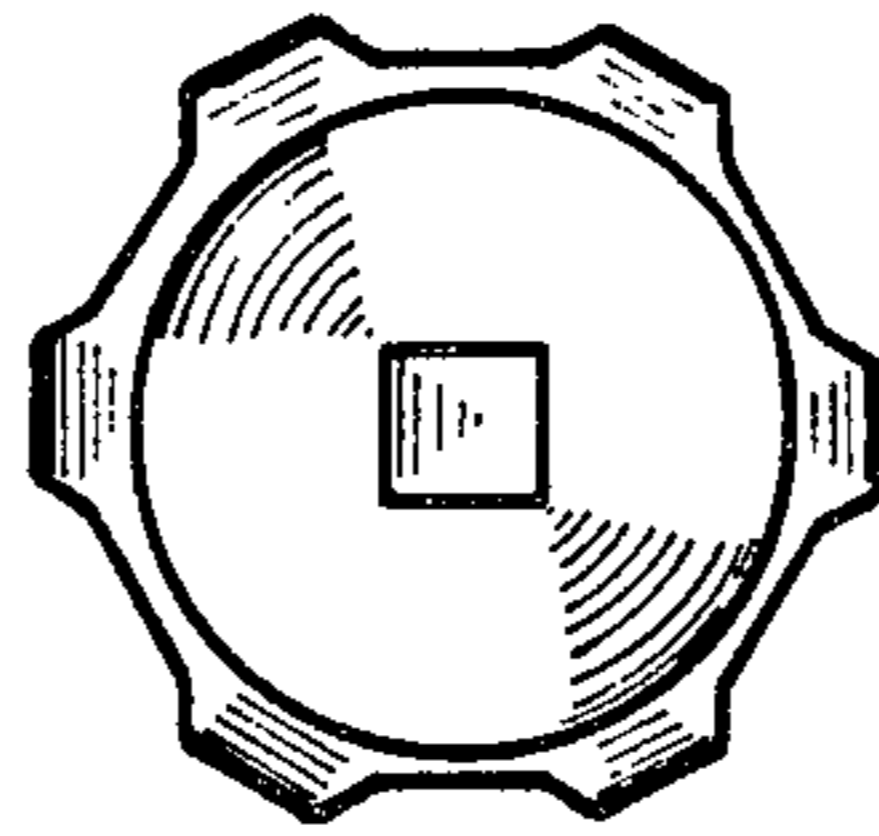

FIG. 4

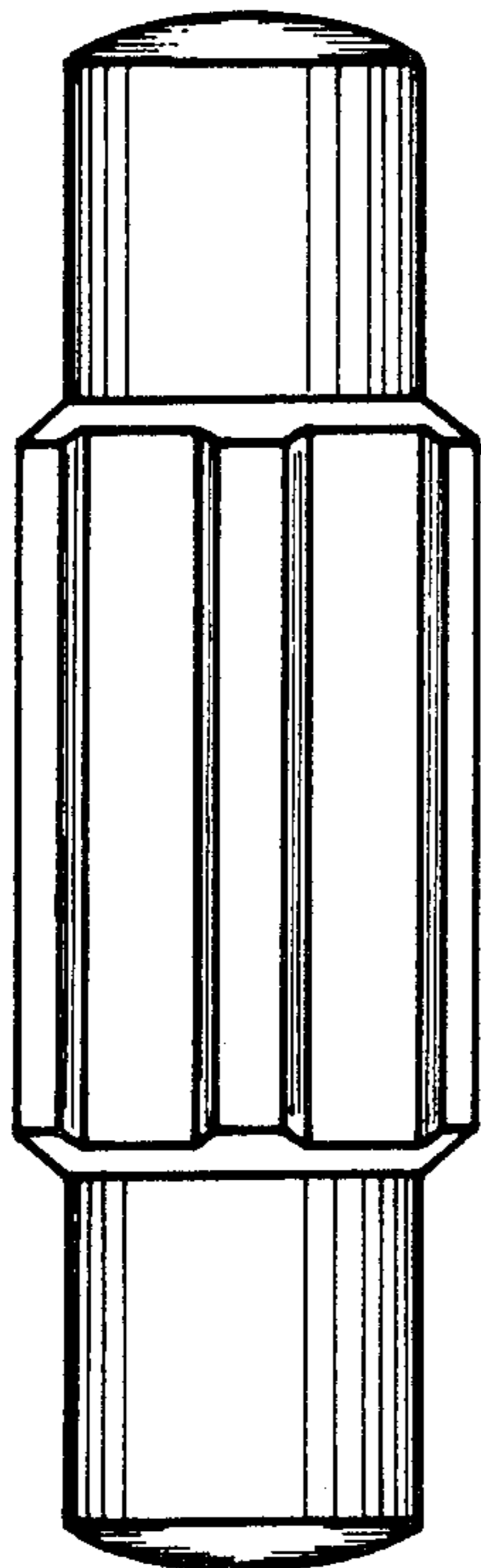

FIG. 6

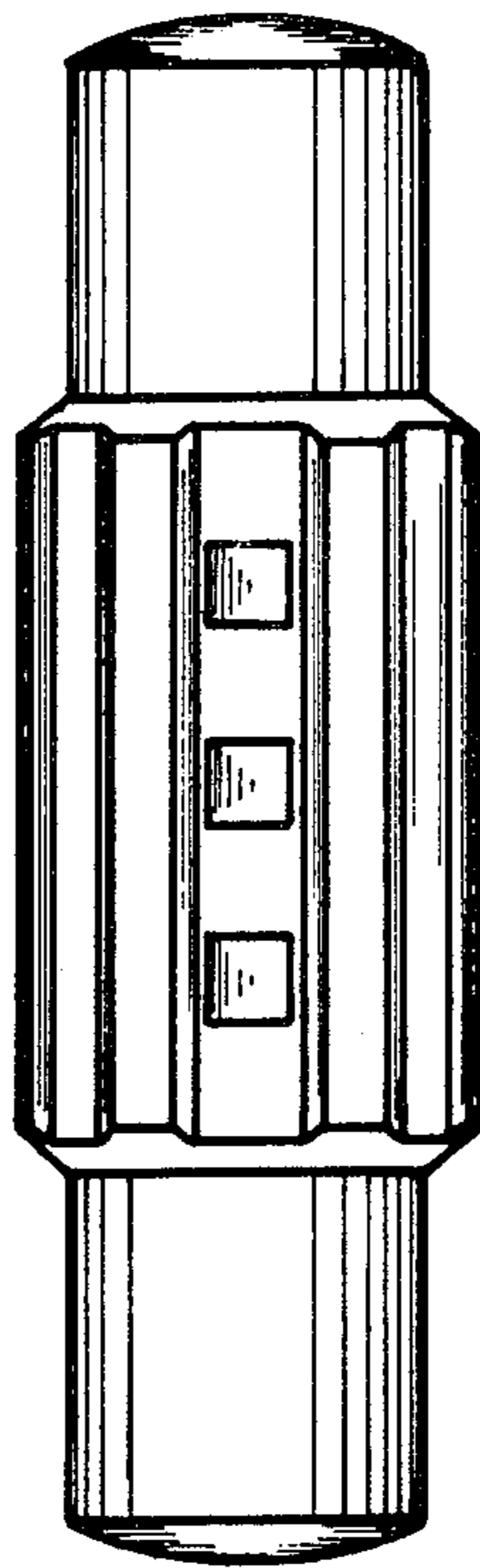

FIG. 3

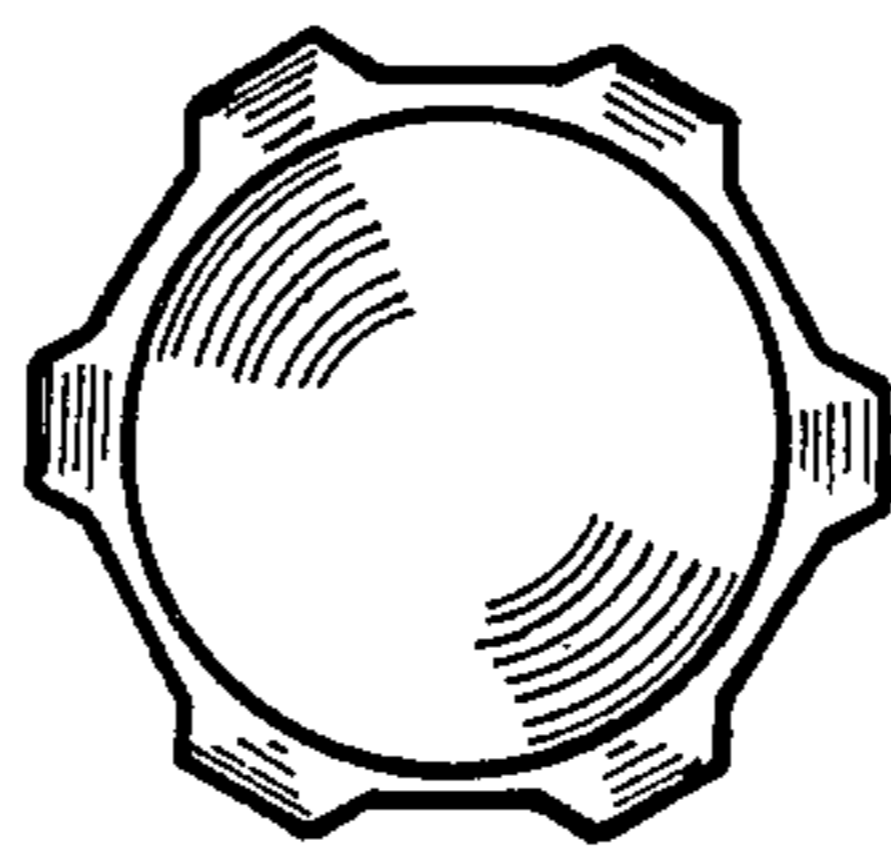

FIG. 5

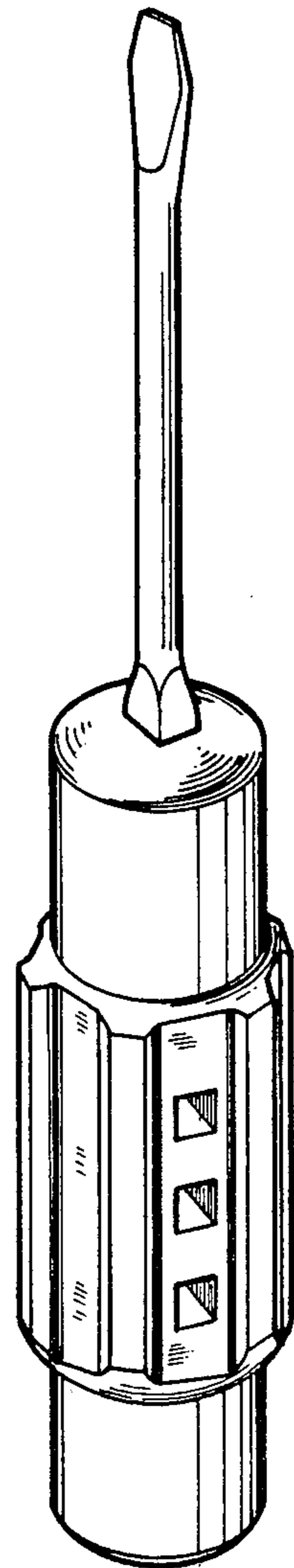

FIG. 1

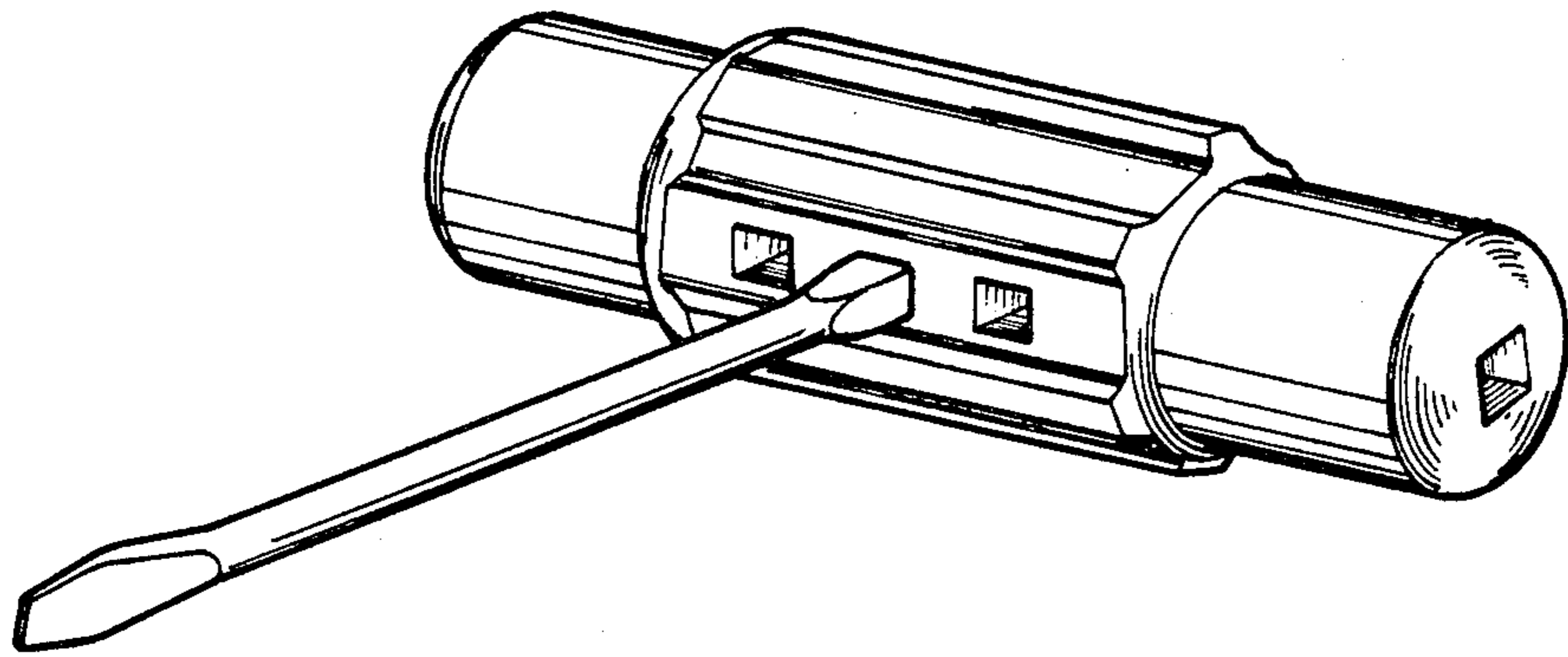

FIG. 2