

[54] SEWING MACHINE

[75] Inventors: Masaaki Tsukizi; Toshiya Sekiguchi, both of Chofu, Japan

[73] Assignee: Tokyo Juki Industrial Co., Ltd., Tokyo, Japan

[\*\*] Term: 14 Years

[21] Appl. No.: 808,356

[22] Filed: Dec. 11, 1985

[30] Foreign Application Priority Data

Jun. 12, 1985 [JP] Japan ..... 60-24694

[52] U.S. Cl. .... D21/69; D21/71

[58] Field of Search ..... D15/66-77; 112/258-261, 217.1, 217.2, 217.3, 217.4

[56] References Cited

U.S. PATENT DOCUMENTS

D. 248,478 7/1978 Kraatz et al. .... D15/72

D. 275,489 9/1984 Kosrow et al. .... D15/71

Primary Examiner—Melvin B. Feifer  
Attorney, Agent, or Firm—Abelman Frayne Rezac & Schwab

[57] CLAIM

The ornamental design for a sewing machine, as shown.

DESCRIPTION

FIG. 1 is a front elevation of the sewing machine showing our new design;

FIG. 2 is a rear elevation of the sewing machine;

FIG. 3 is a side elevation of the sewing machine taken from the left-hand side of FIG. 1;

FIG. 4 is a side elevation of the sewing machine taken from the right-hand side of FIG. 1;

FIG. 5 is a plan view of the sewing machine;

FIG. 6 is an underside plan view of the sewing machine; and,

FIG. 7 is a front perspective view of the sewing machine.

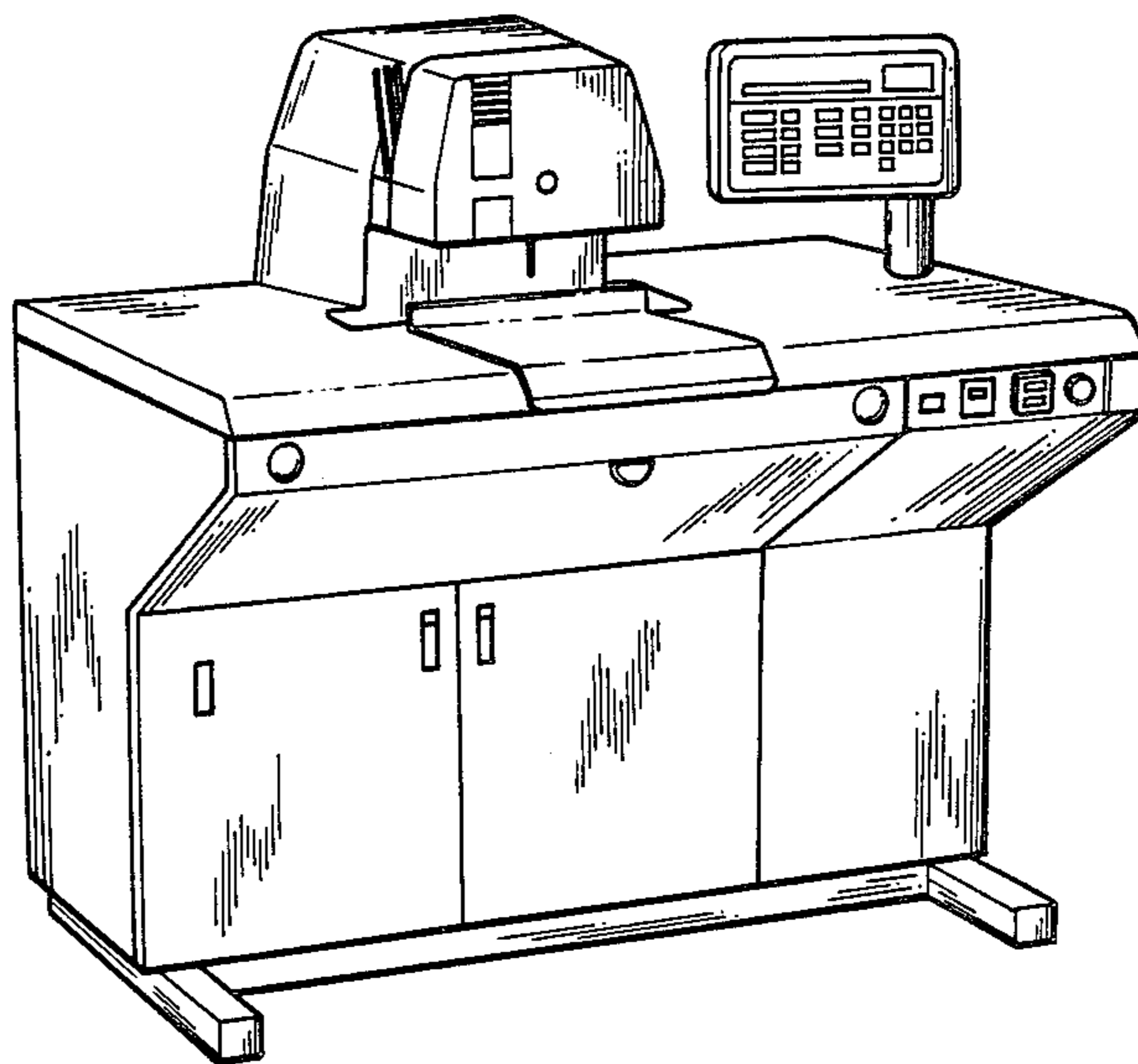

FIG. 1

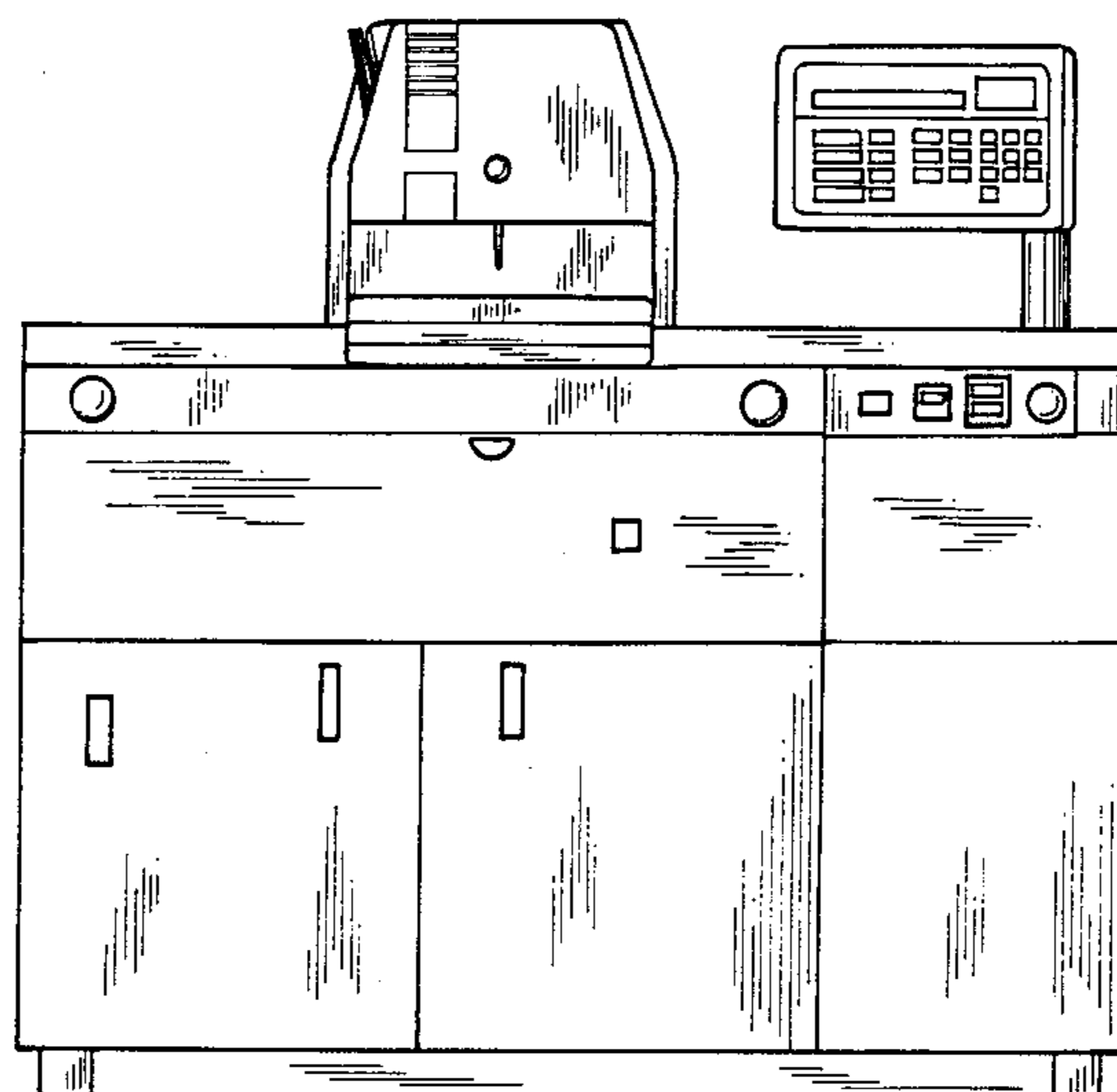

FIG. 2

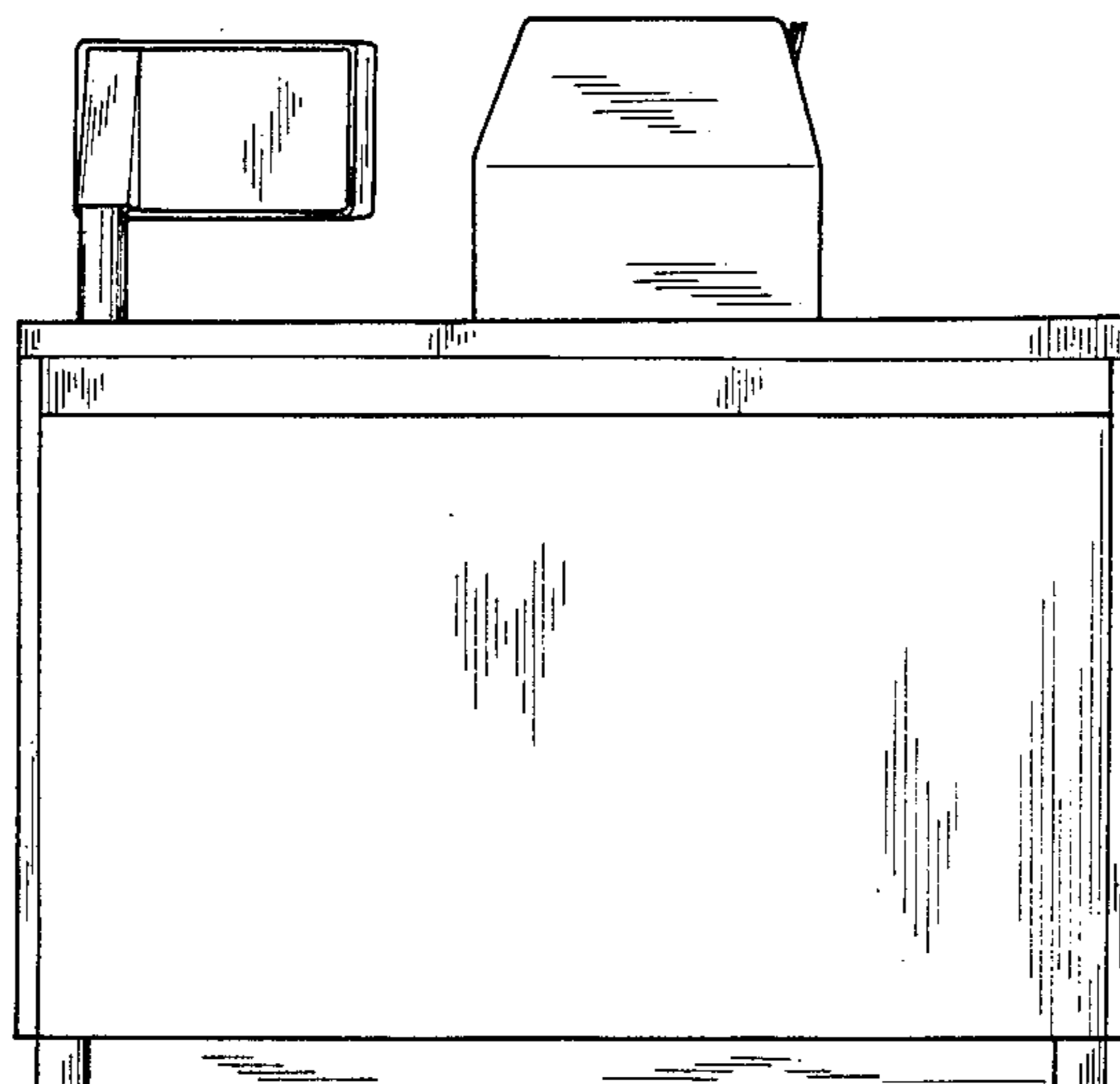

FIG. 3

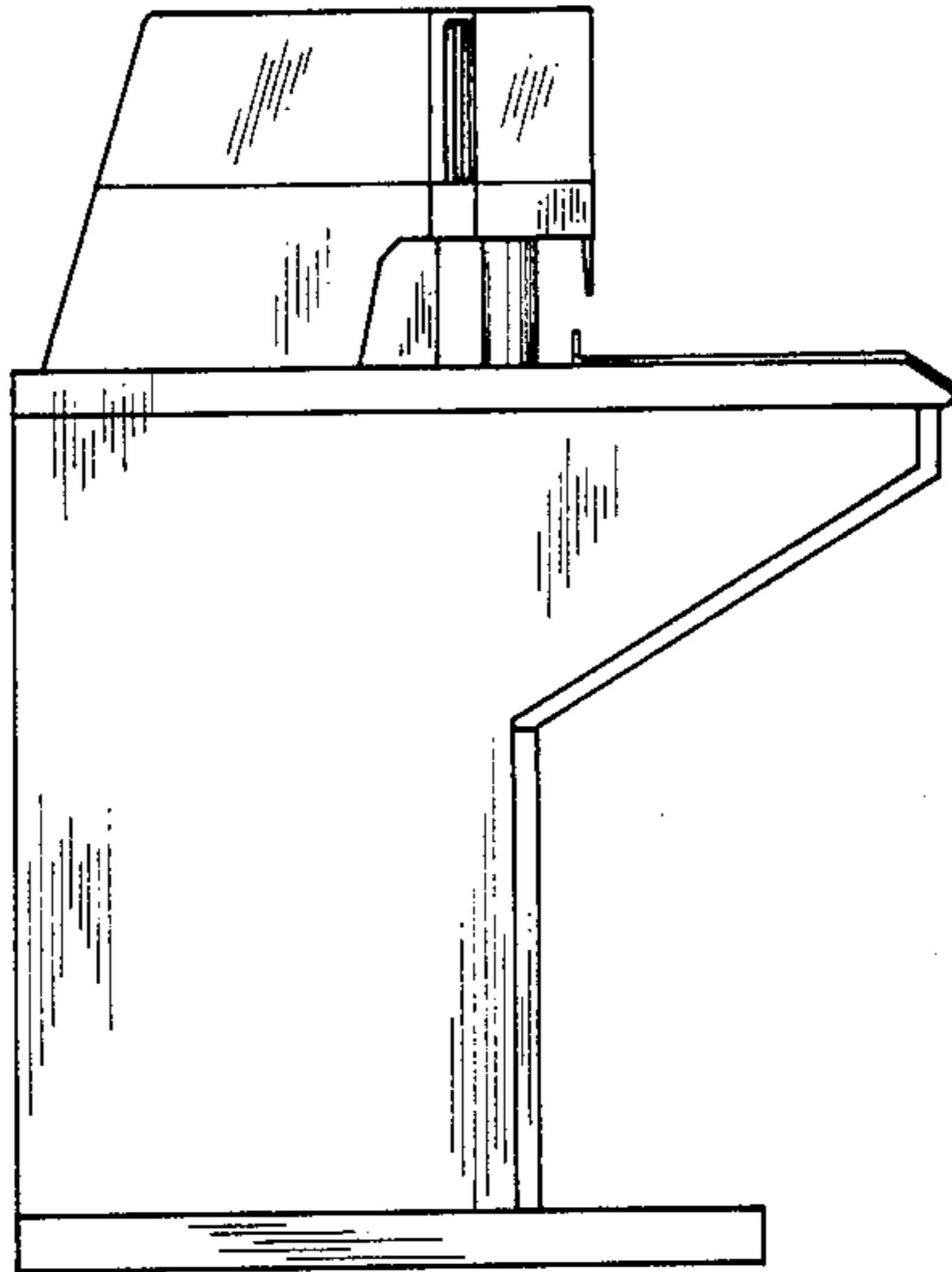

FIG. 4

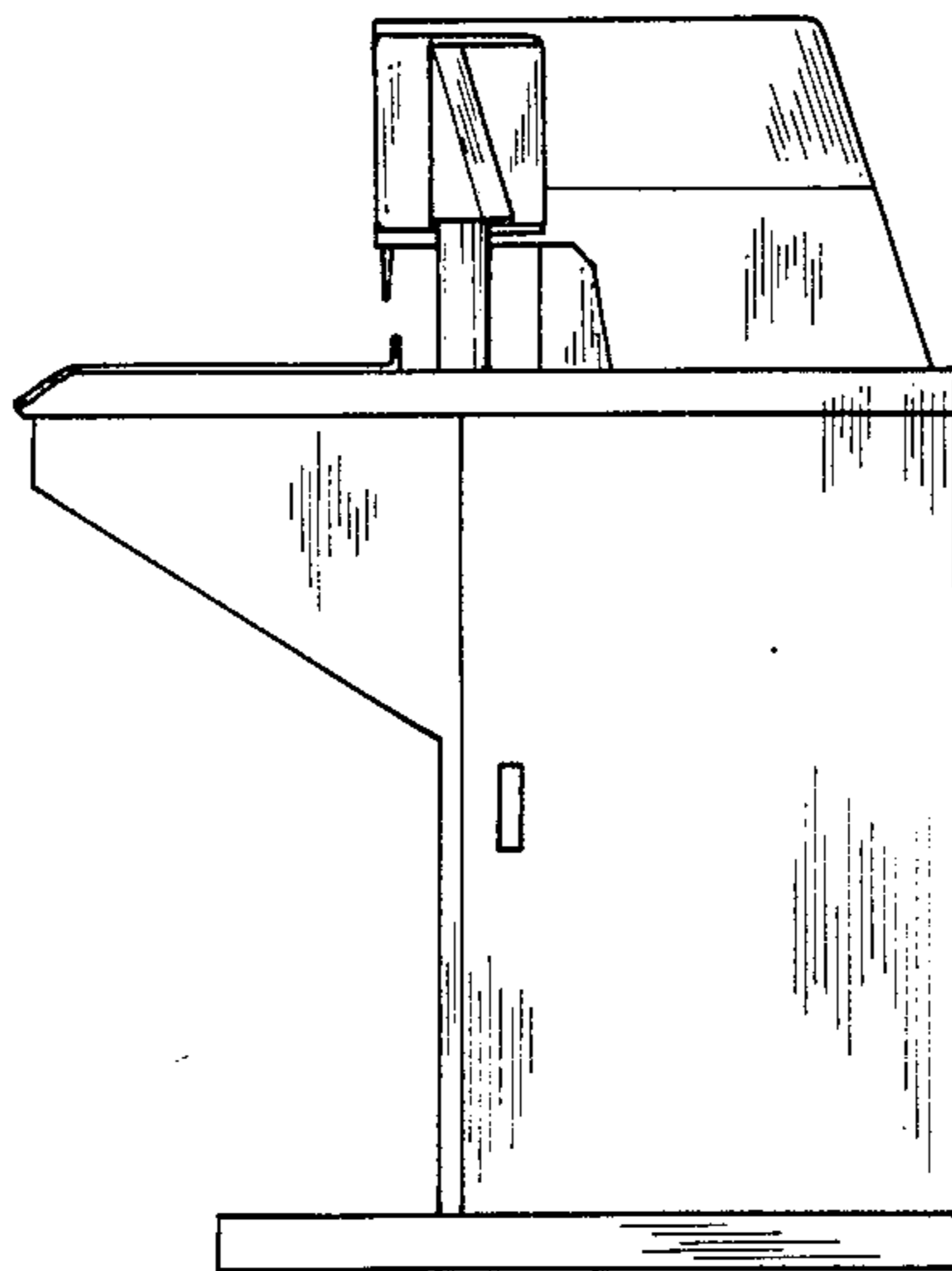

FIG.5

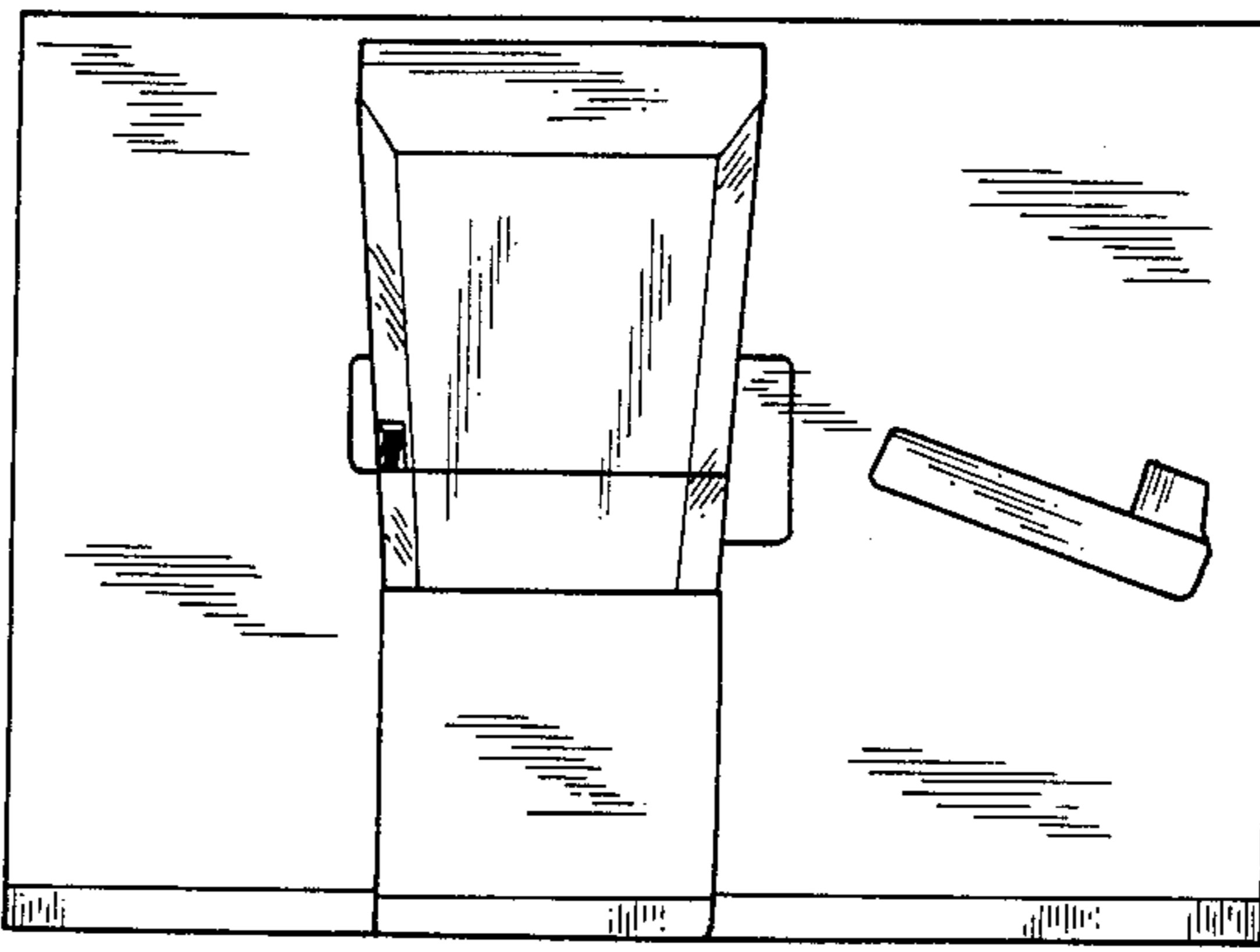

FIG.6

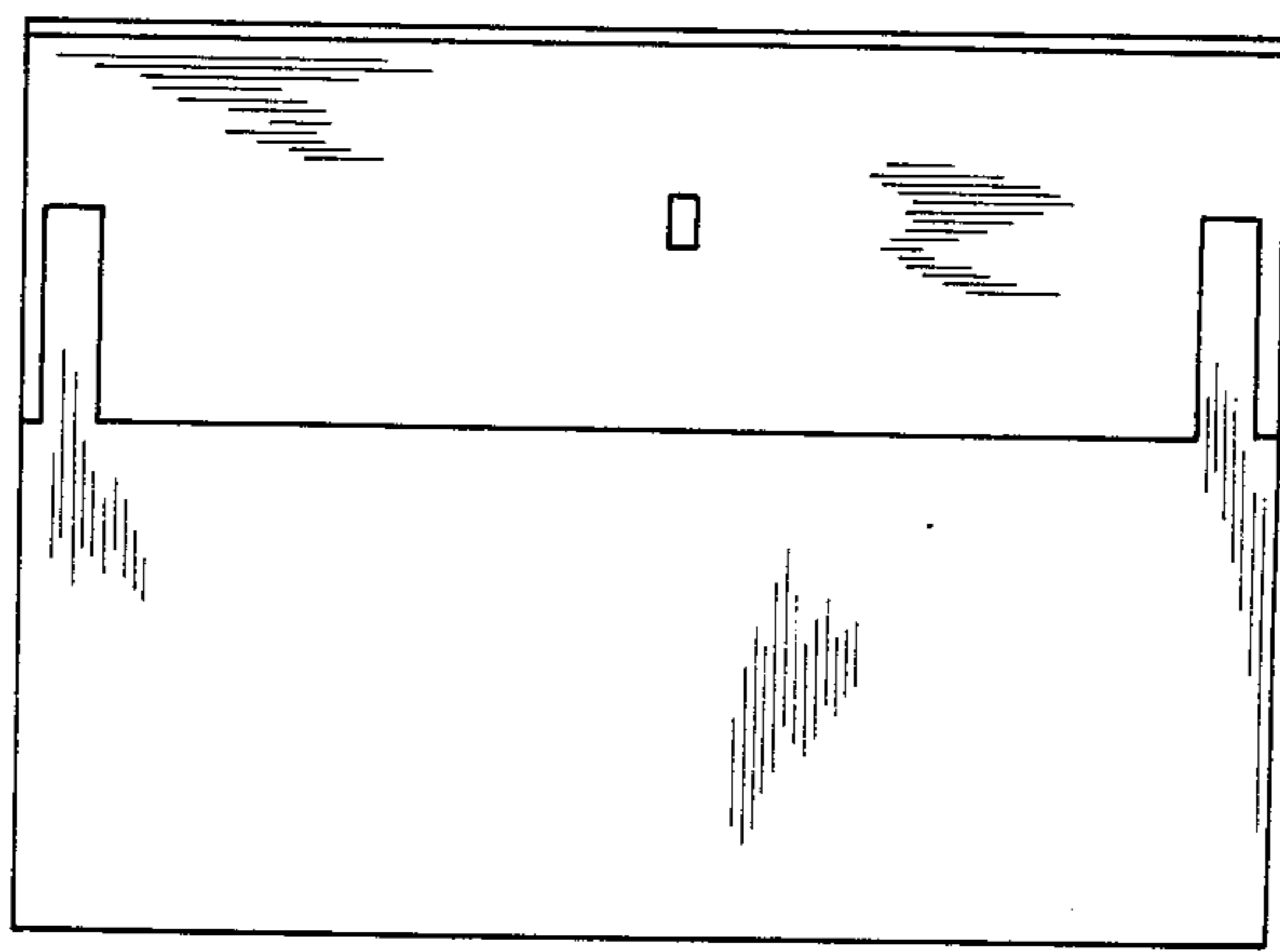

FIG. 7

