

[54] TRUCK REAR BUMPER

[75] Inventor: Jay E. Trinnaman, Orem, Utah

[73] Assignee: Michael A. Abraham, Newport Beach, Calif.

[**] Term: 14 Years

[21] Appl. No.: 869,951

[22] Filed: Jun. 2, 1986

[52] U.S. Cl. D12/169

[58] Field of Search D12/169; 293/102

[56] References Cited

U.S. PATENT DOCUMENTS

D. 74,978 4/1928 Jandus et al. D12/169

OTHER PUBLICATIONS

Hot Rod, 8/79, p. 62, front bumper on pickup truck, upper right side of page.

J. C. Whitney catalog No. 454D, ©1985, p. 42. Double-Tube Rear Bumper, bottom left side of page. Nissan Motor Corporation brochure entitled "Nissan Trucks", 1985, cover page, p. 18 and last page, rear bumper on pickup truck.

Primary Examiner—James M. Gandy
Attorney, Agent, or Firm—Trask, Britt & Rossa

[57] CLAIM

The ornamental design for a truck rear bumper, as shown and described.

DESCRIPTION

FIG. 1 is a front perspective view of a truck rear bumper showing my design;
FIG. 2 is a side elevational view, the side opposite being a reverse mirror image thereof;
FIG. 3 is a top plan view;
FIG. 4 is a front elevational view;
FIG. 5 is a back elevational view; and
FIG. 6 is a bottom plan view.

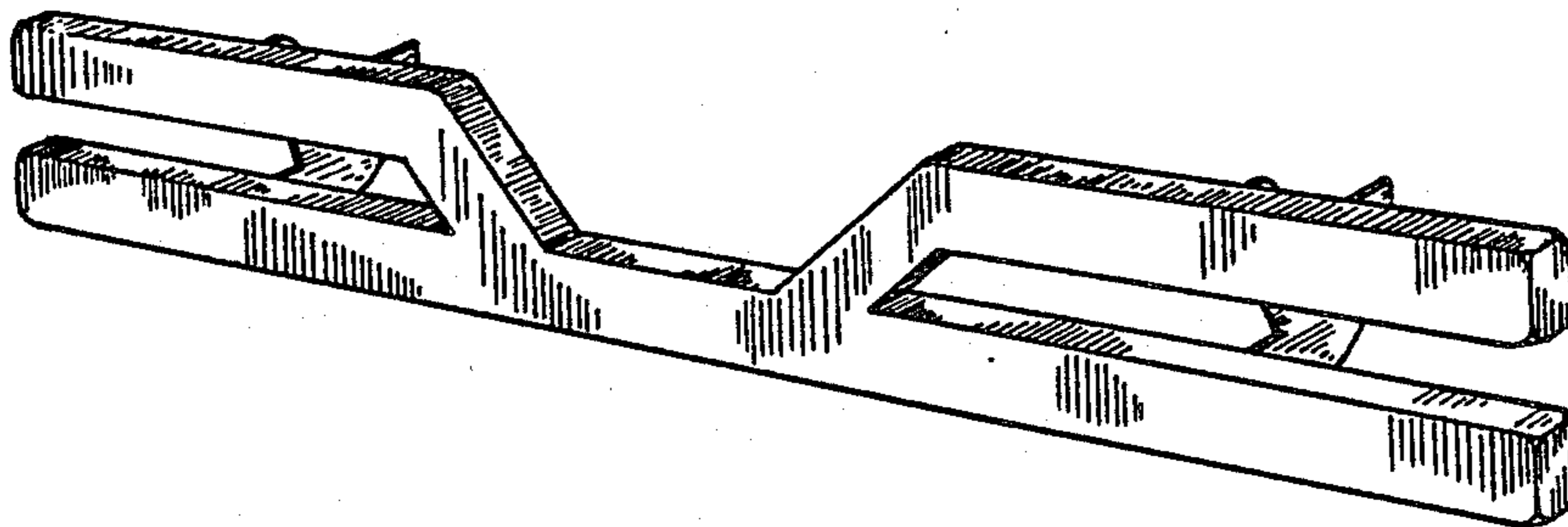

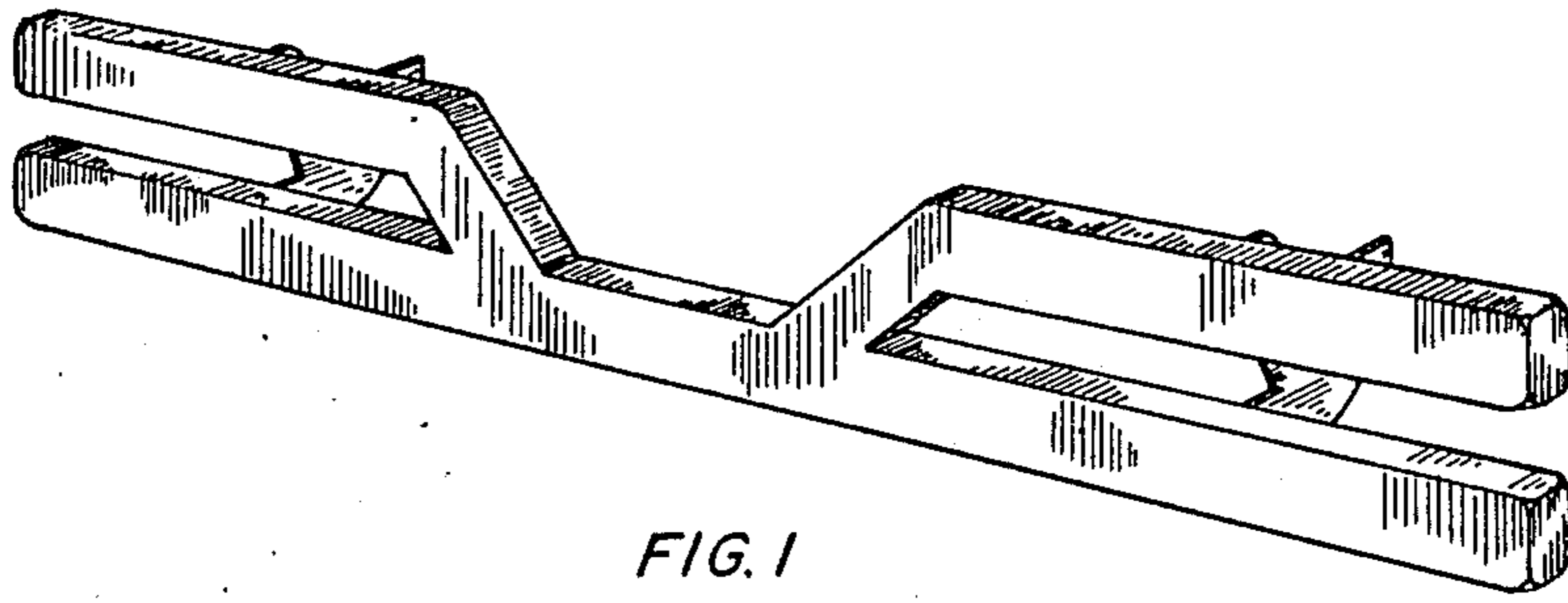

FIG. 1

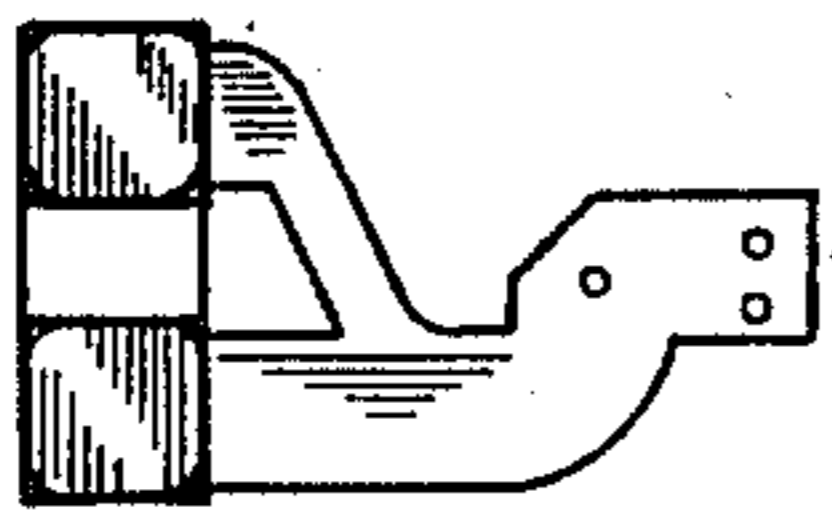

FIG. 2

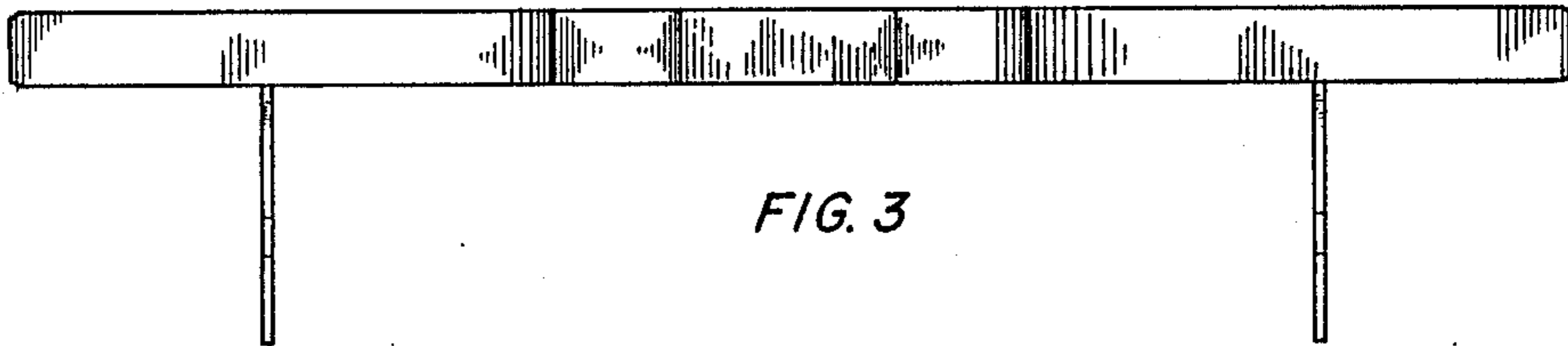

FIG. 3

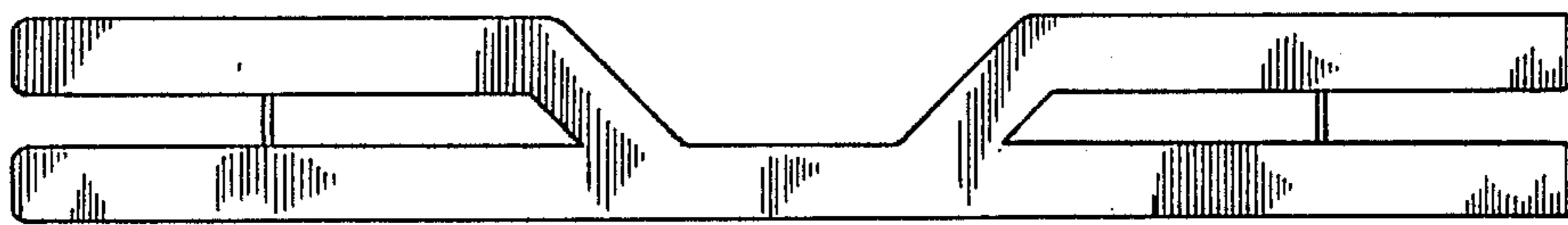

FIG. 4

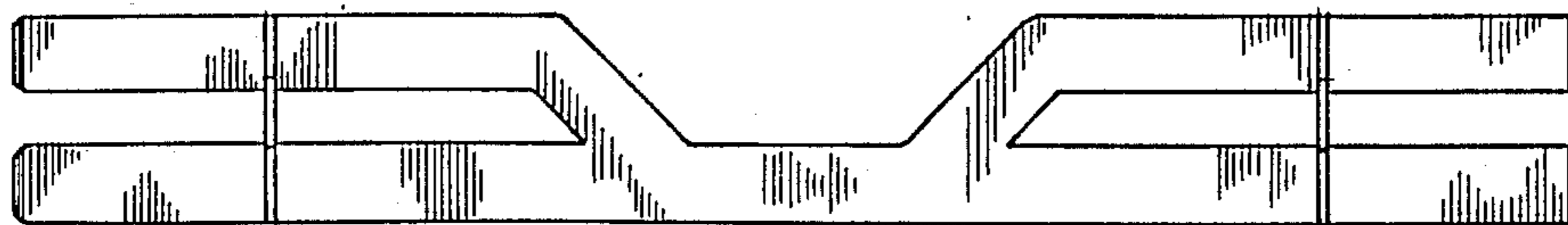

FIG. 5

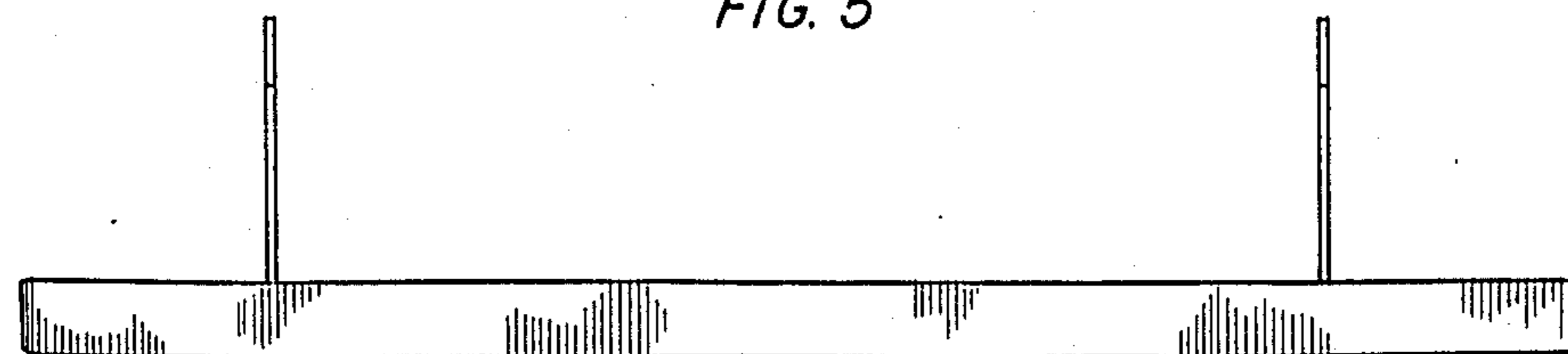

FIG. 6