

[54] **DISPENSING CONTAINER**
[75] **Inventor: Ma C. Hung, Kowloon, Hong Kong**
[73] **Assignee: Rain and Coat Garment Factory Limited, Hong Kong, Hong Kong**
[**] **Term: 14 Years**
[21] **Appl. No.: 816,058**
[22] **Filed: Jan. 3, 1986**

[30] **Foreign Application Priority Data**
Jul. 3, 1985 [GB] United Kingdom 1027696
[52] **U.S. Cl. D7/76**
[58] **Field of Search D7/76, 301; D20/7; 194/255; 221/265, 266; 222/362, 370**

[56] **References Cited**
U.S. PATENT DOCUMENTS
D. 279,643 7/1985 Jensen D7/76
1,441,438 1/1923 Leonhardt 222/370 X
Primary Examiner—Bernard Ansher
Assistant Examiner—Terry Pfeffer
Attorney, Agent, or Firm—Birch, Stewart, Kolasch & Birch

[57] **CLAIM**
The ornamental design for a dispensing container, as shown and described.

DESCRIPTION
FIG. 1 is a perspective view of a dispensing container showing my new design;
FIG. 2 is a rear elevational view thereof;
FIG. 3 is a bottom plan view thereof;
FIG. 4 is a top plan view thereof;
FIG. 5 is a right-side elevational view thereof;
FIG. 6 is a front elevational view thereof; and
FIG. 7 is a left-side elevational view thereof.

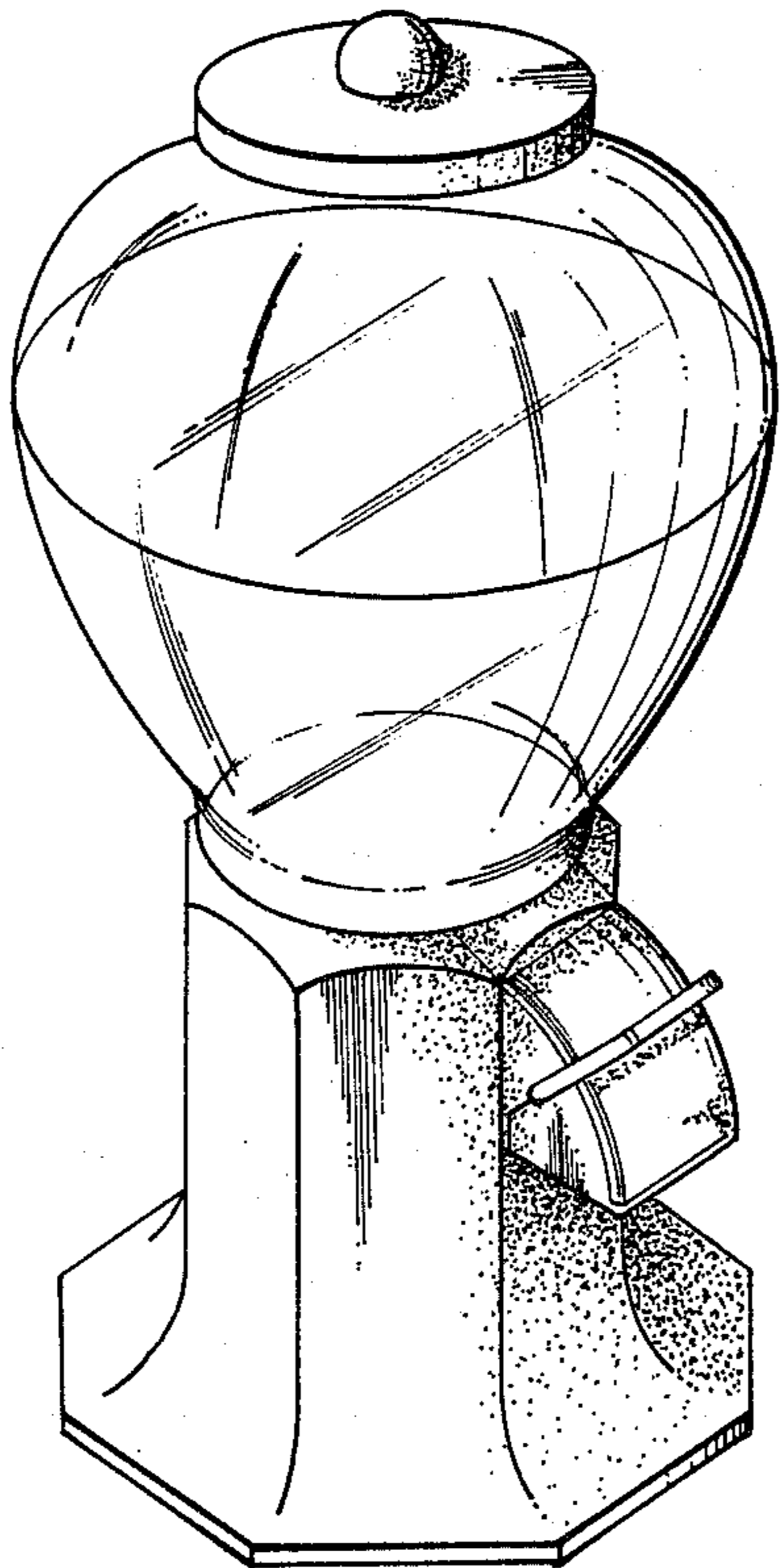

FIG. 1

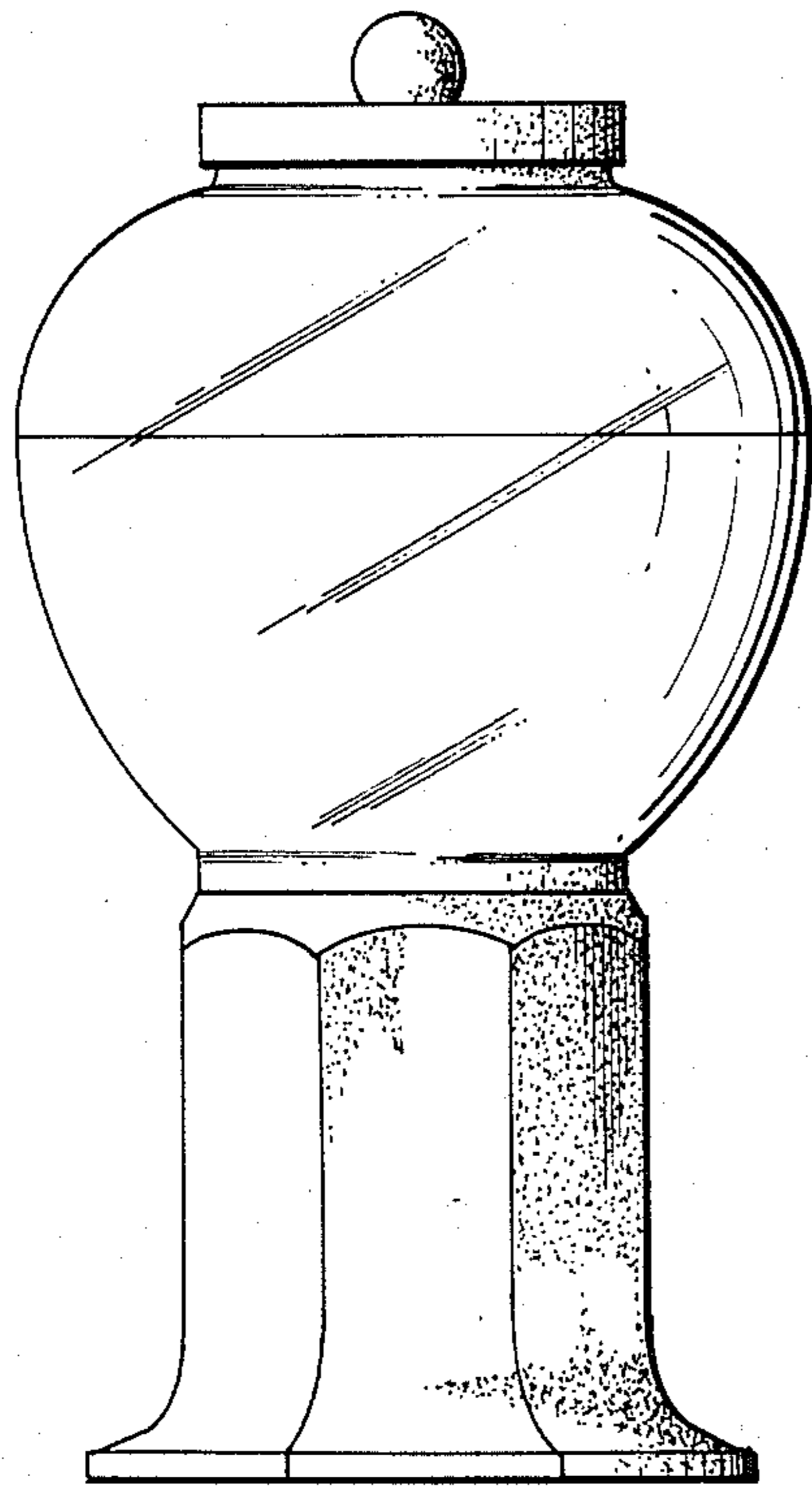
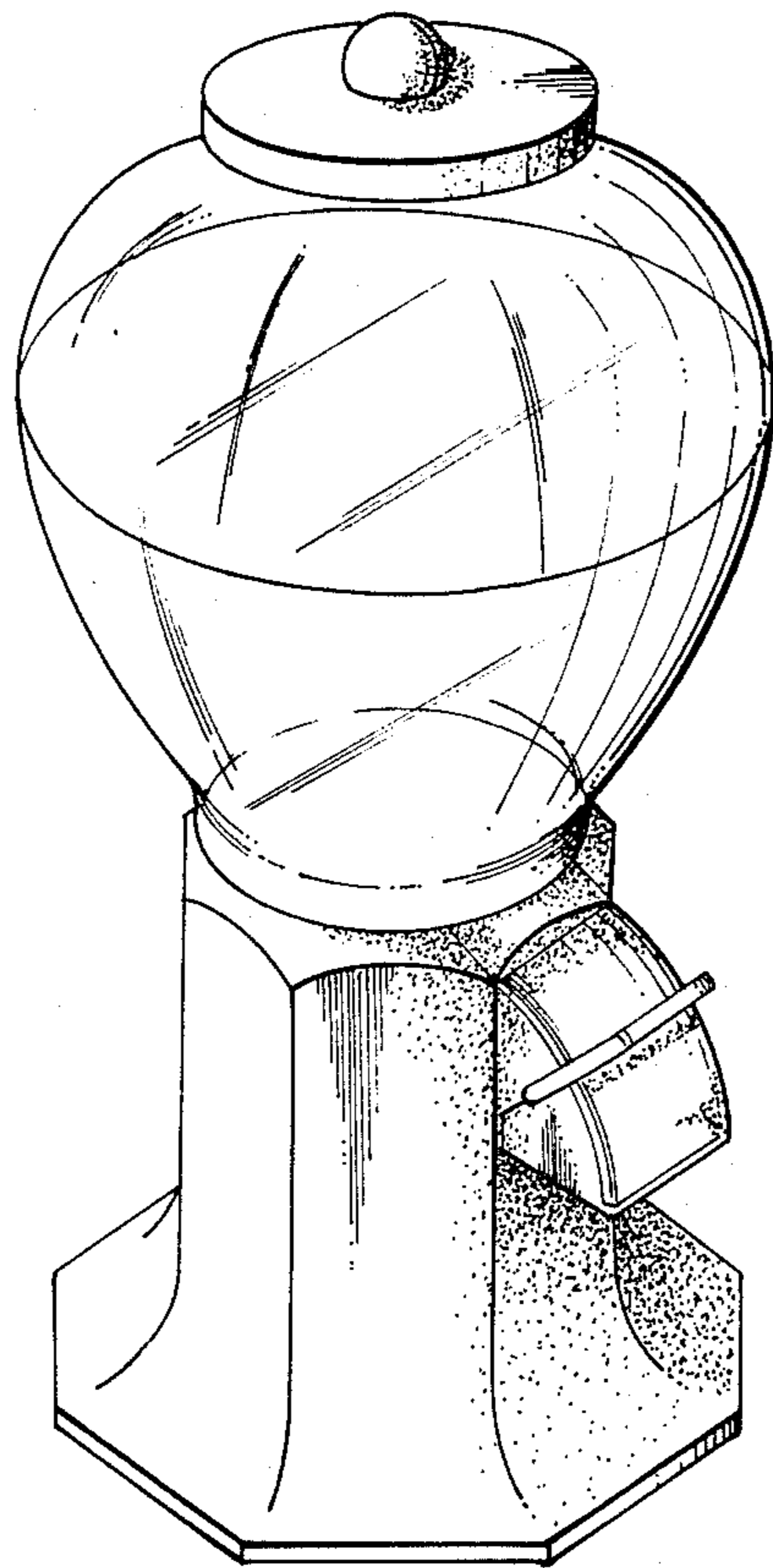

FIG. 2

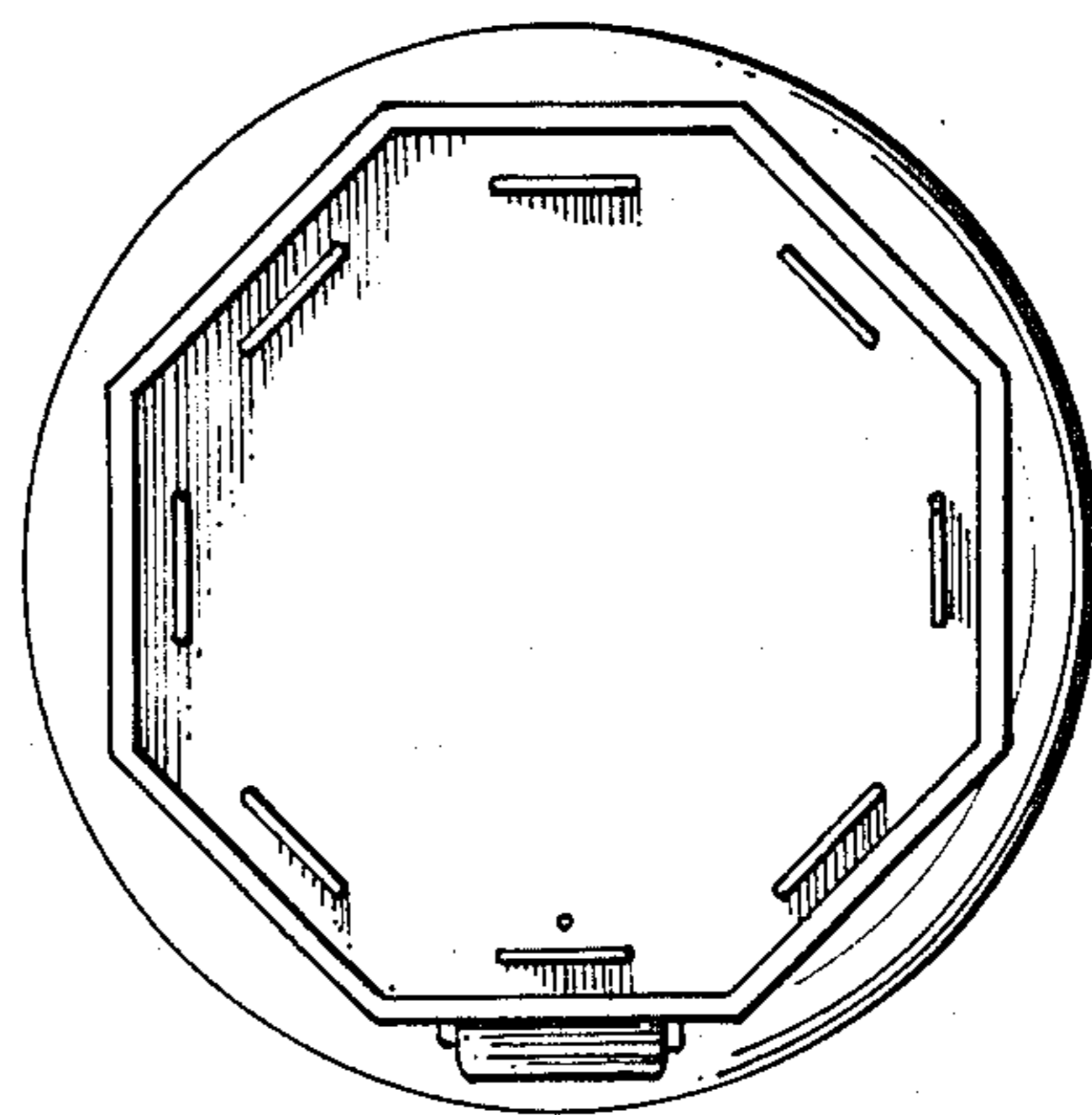

FIG. 3

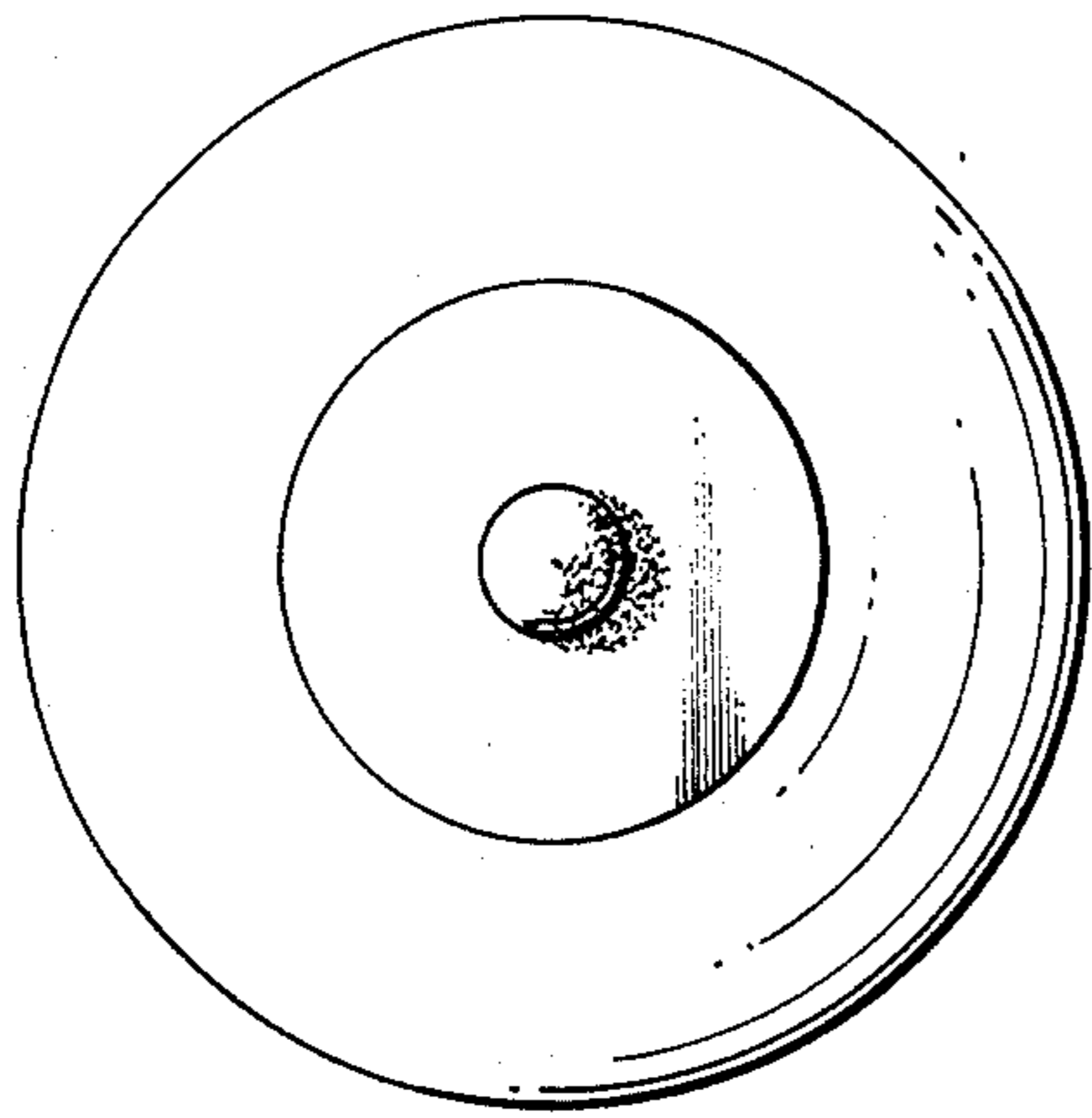

FIG. 4

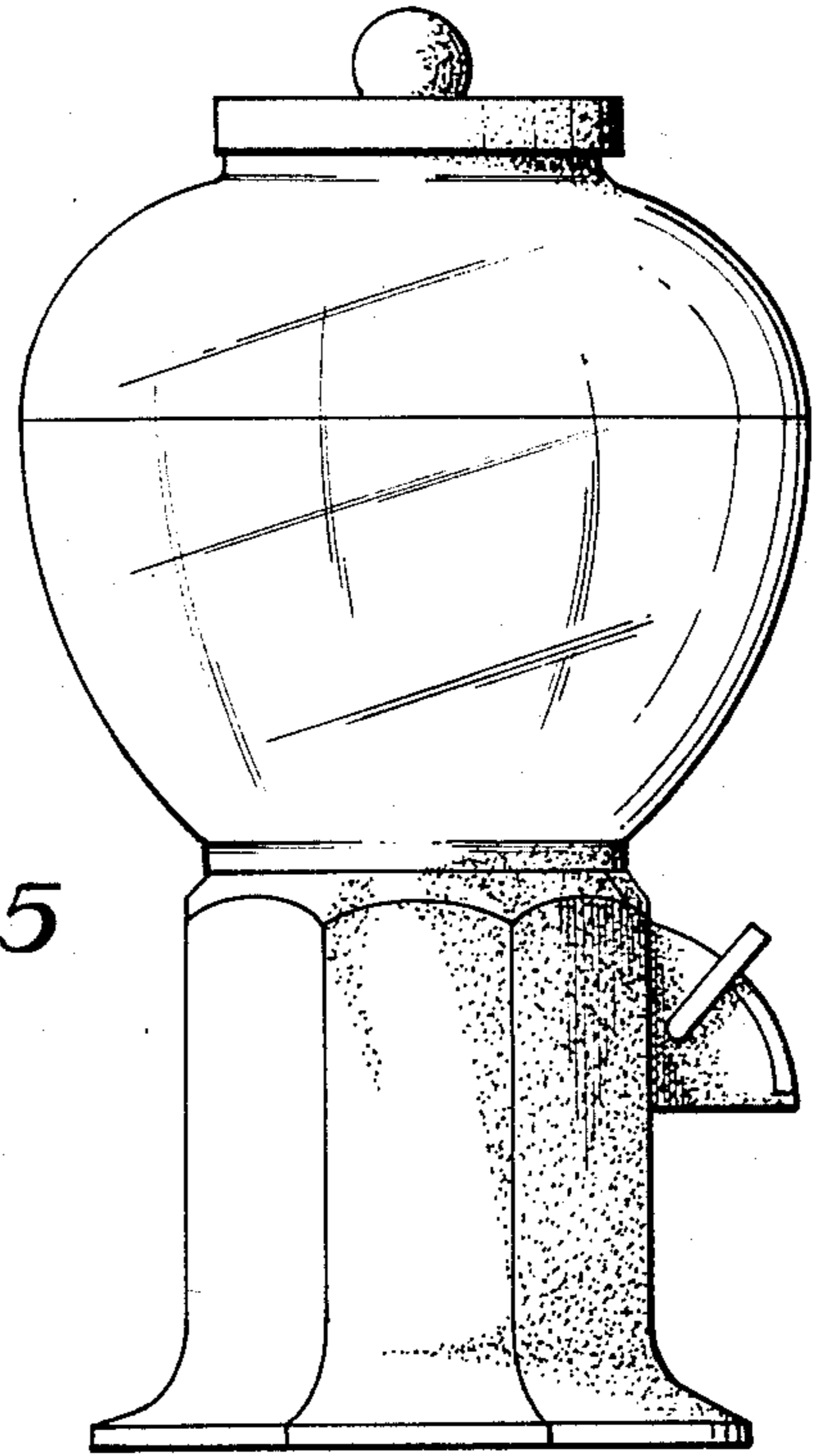

FIG. 5

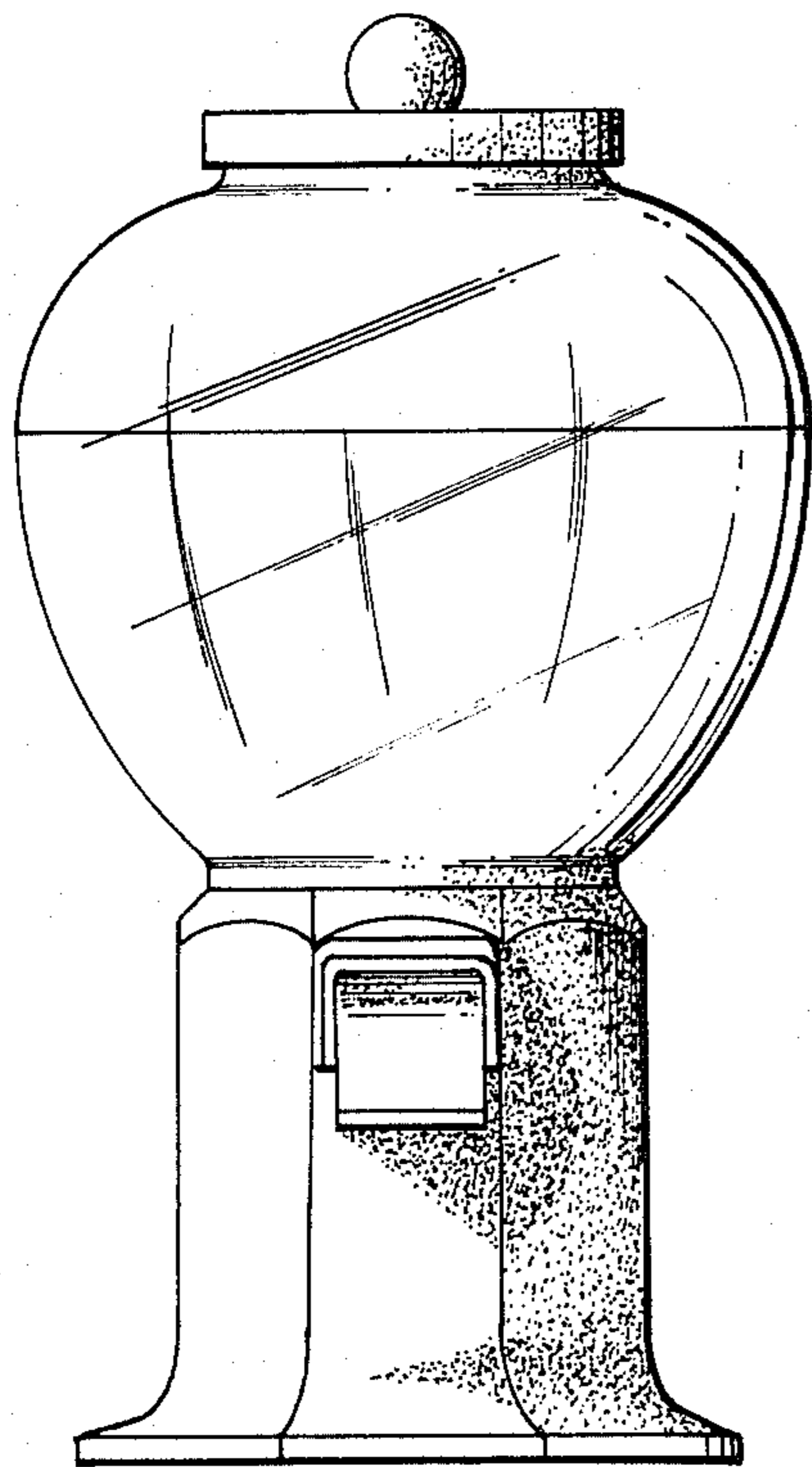

FIG. 6

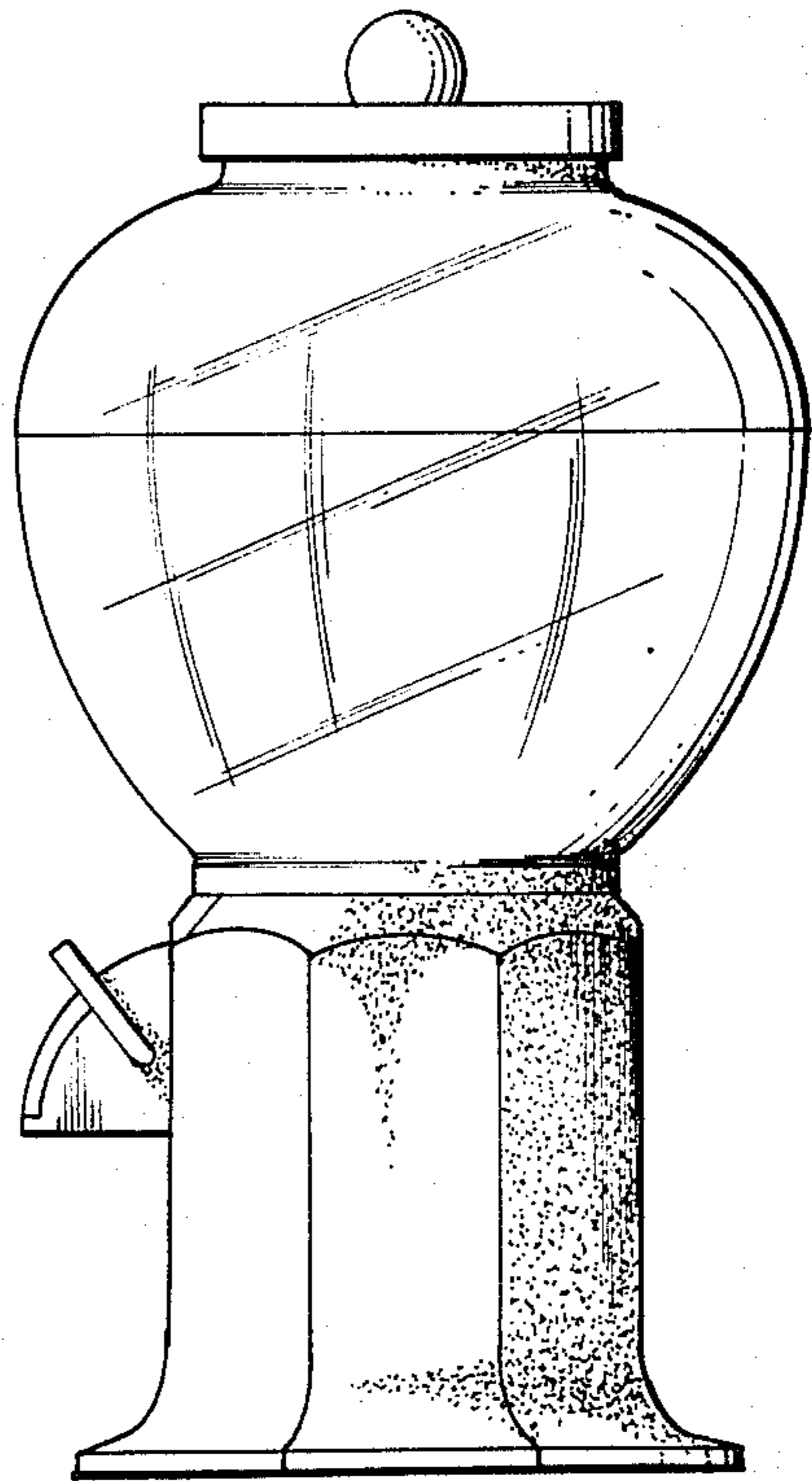

FIG. 7