

[54] **COMBINED DUST PAN AND DUST BROOM**

[75] **Inventor: Carsten Jorgensen, Kriens, Switzerland**

[73] **Assignee: Britbo Holding AG, Switzerland**

[**] **Term: 14 Years**

[21] **Appl. No.: 733,860**

[22] **Filed: May 14, 1985**

[52] **U.S. Cl. D32/74; D4/116**

[58] **Field of Search D32/74; D4/116, 130, D4/132, 134; 15/159 R, 160, 257.1-257.9**

[56] **References Cited**

U.S. PATENT DOCUMENTS

129,935	7/1872	Conger	15/257.2
391,083	10/1888	Sawtelle	15/257.2
2,172,808	9/1939	Roy	15/257.2
3,382,523	5/1968	Parsisson	15/257.2

FOREIGN PATENT DOCUMENTS

1013435 12/1965 United Kingdom 15/257.2

Primary Examiner—Catherine E. Kemper
Attorney, Agent, or Firm—Larson & Taylor

[57] **CLAIM**

The ornamental design for a combined dust pan and dust broom, as shown and described.

DESCRIPTION

FIG. 1 is a perspective view of a combined dust pan and dust broom, showing my new design;
FIG. 2 is an end elevation view of the dust broom;
FIG. 3 is a side elevation view thereof;
FIG. 4 is an end elevation view of the dust pan;
FIG. 5 is a top plan view thereof;
FIG. 6 is a sectional view taken along line 6—6 of FIG. 5;
FIG. 7 is a sectional view taken along line 7—7 of FIG. 5.

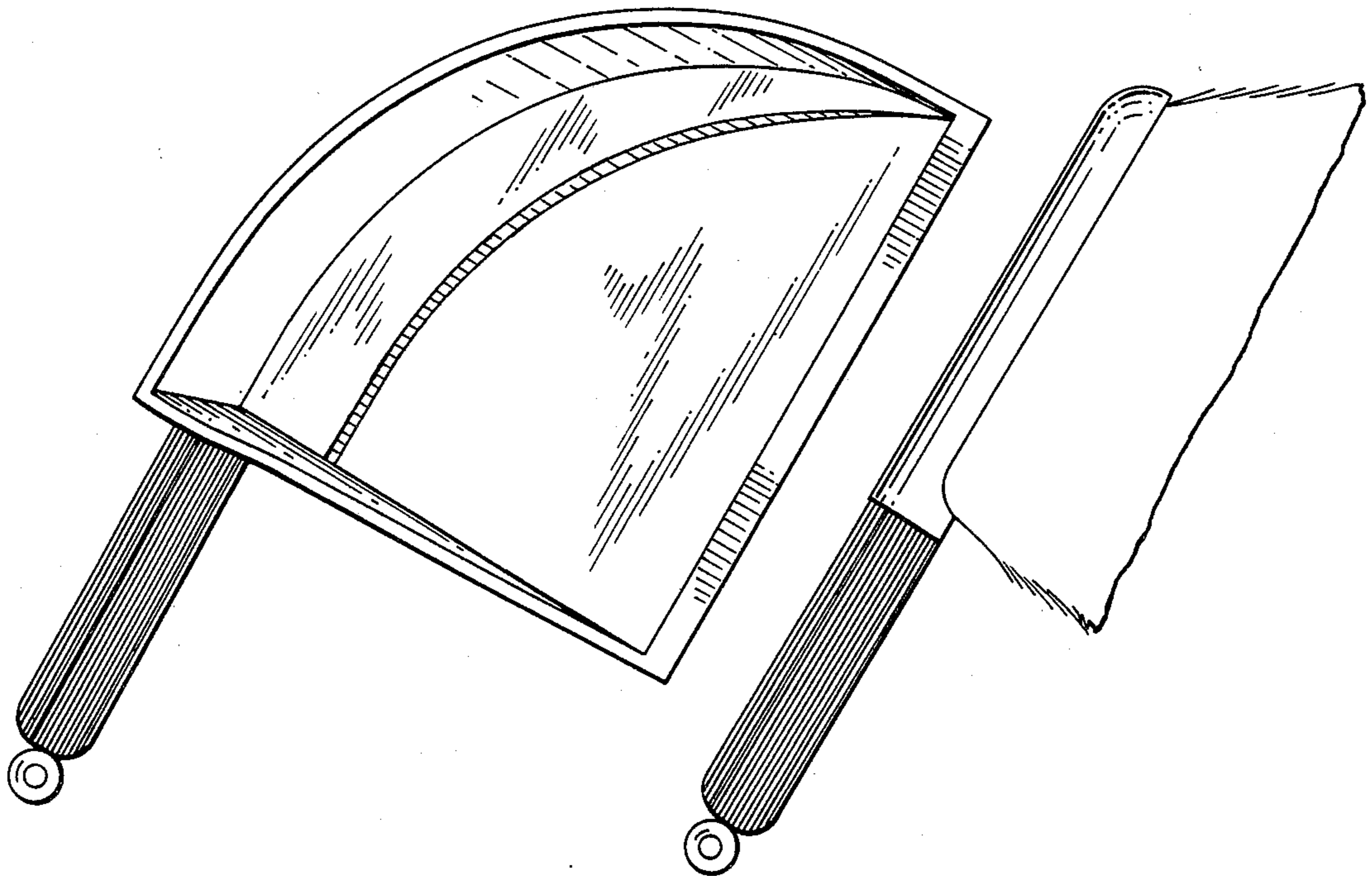

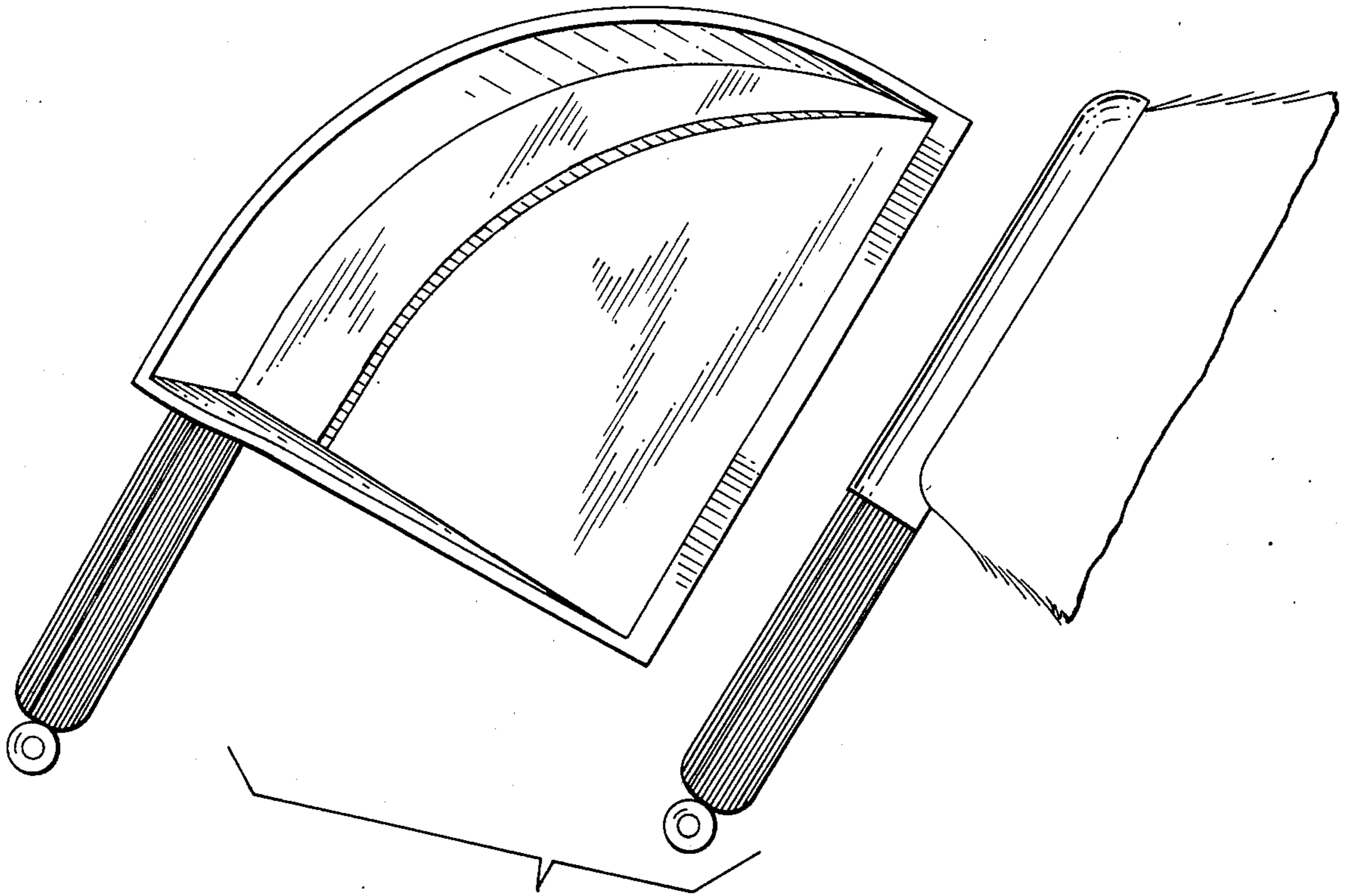

FIG. 1

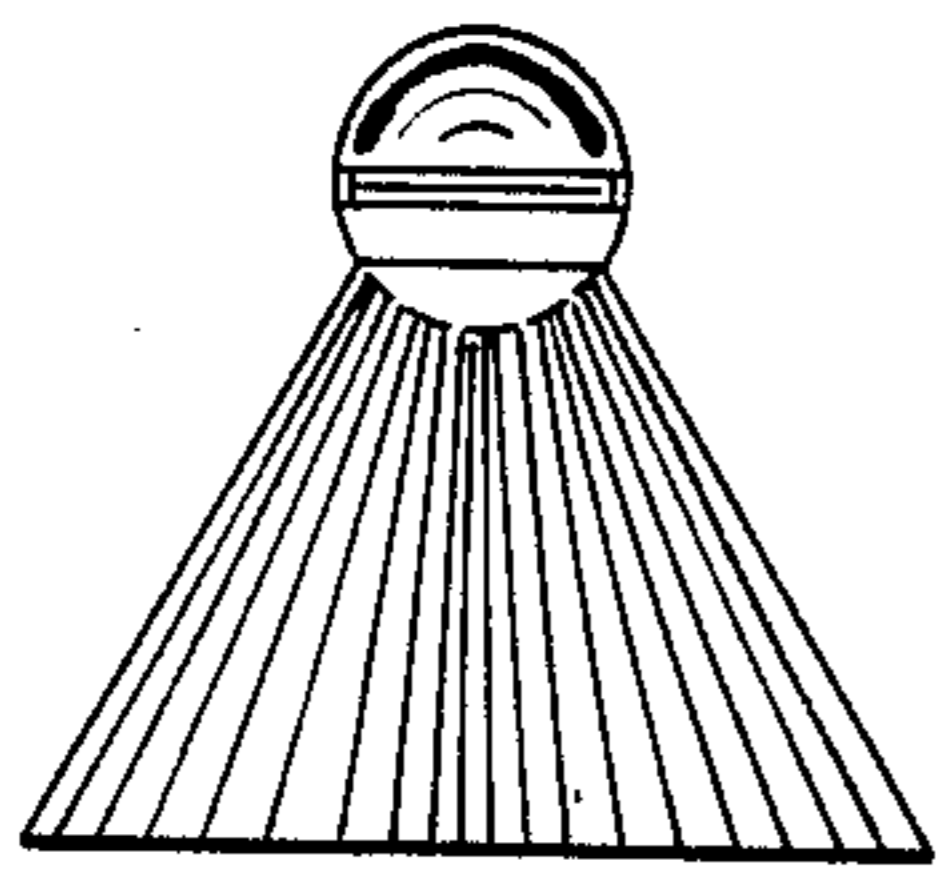

FIG. 2

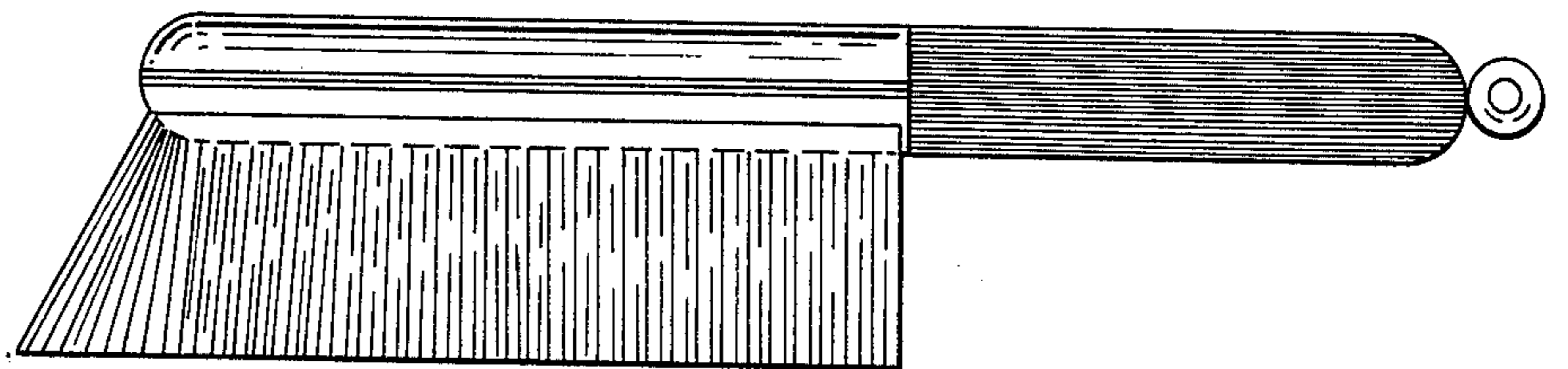

FIG. 3

