

[54] **HOLDER FOR SHEET MUSIC OR SIMILAR ARTICLE**

[76] **Inventor: Gene Johnson, P.O. Box 3520, Estes Park, Colo. 80517**

[\*\*] **Term: 14 Years**

[21] **Appl. No.: 759,899**

[22] **Filed: Jul. 29, 1985**

[52] **U.S. Cl. .... D19/90**

[58] **Field of Search ..... D19/90-99;  
D14/114; D16/32**

[56] **References Cited**

**U.S. PATENT DOCUMENTS**

D. 220,597 4/1971 Dawson et al. .... D14/114  
D. 223,732 5/1972 Misenko ..... D19/99  
D. 258,066 1/1981 DeGregorio ..... D16/32

**OTHER PUBLICATIONS**

Smead Mfg. Co. Flier-Office Appliances, 10-1960, p. 86, Vertical File #5.

*Primary Examiner*—Charles A. Rademaker

[57] **CLAIM**

The ornamental design for a holder for sheet music or similar article, as shown and described.

**DESCRIPTION**

FIG. 1 is a top plan view of a holder for sheet music or similar article showing my new design;  
FIG. 2 is a front elevational view thereof;  
FIG. 3 is a side elevational view thereof;  
FIG. 4 is a rear elevational view of the side opposite that shown in FIG. 2;  
FIG. 5 is a side elevational view of the side opposite that shown in FIG. 3;  
FIG. 6 is a bottom plan view thereof; and  
FIG. 7 is a perspective view thereof.  
The texture shown in fragment in the drawings represent overall patterns within the indicated areas only.

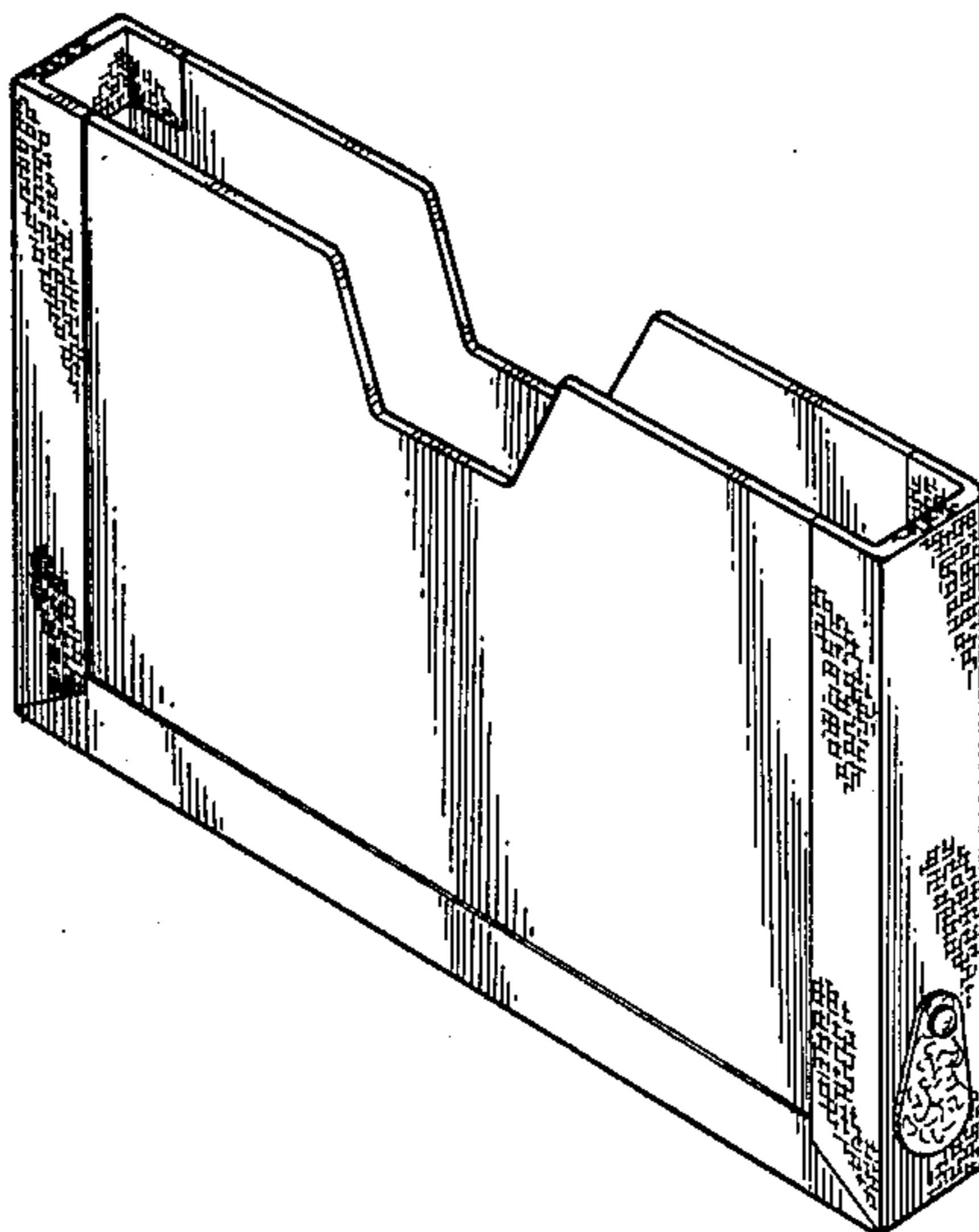

FIG. 1

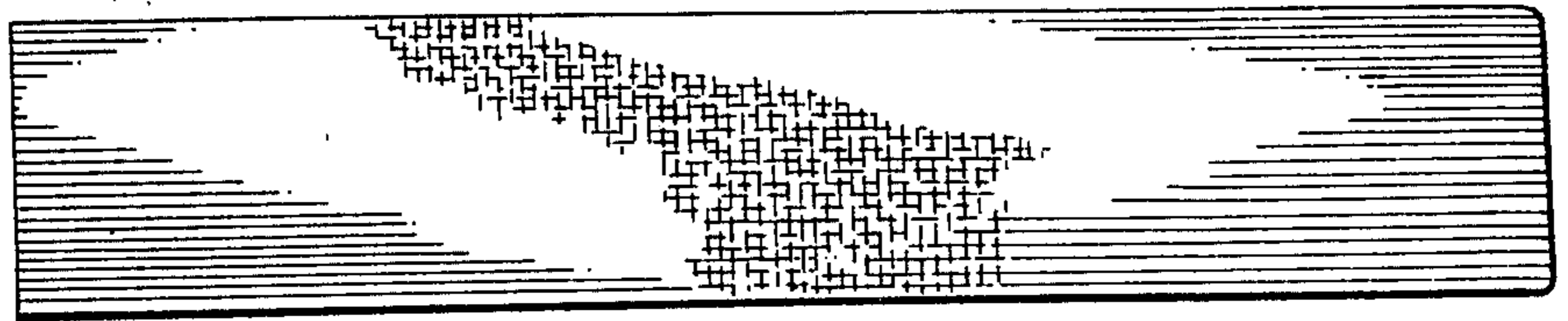

FIG. 2

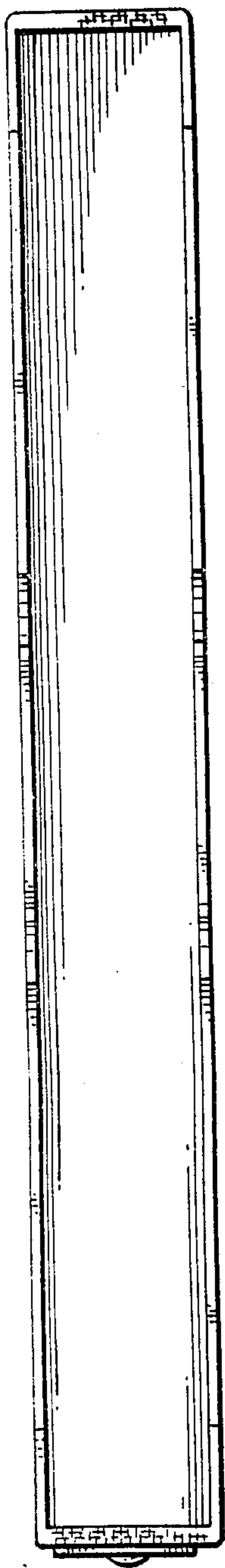
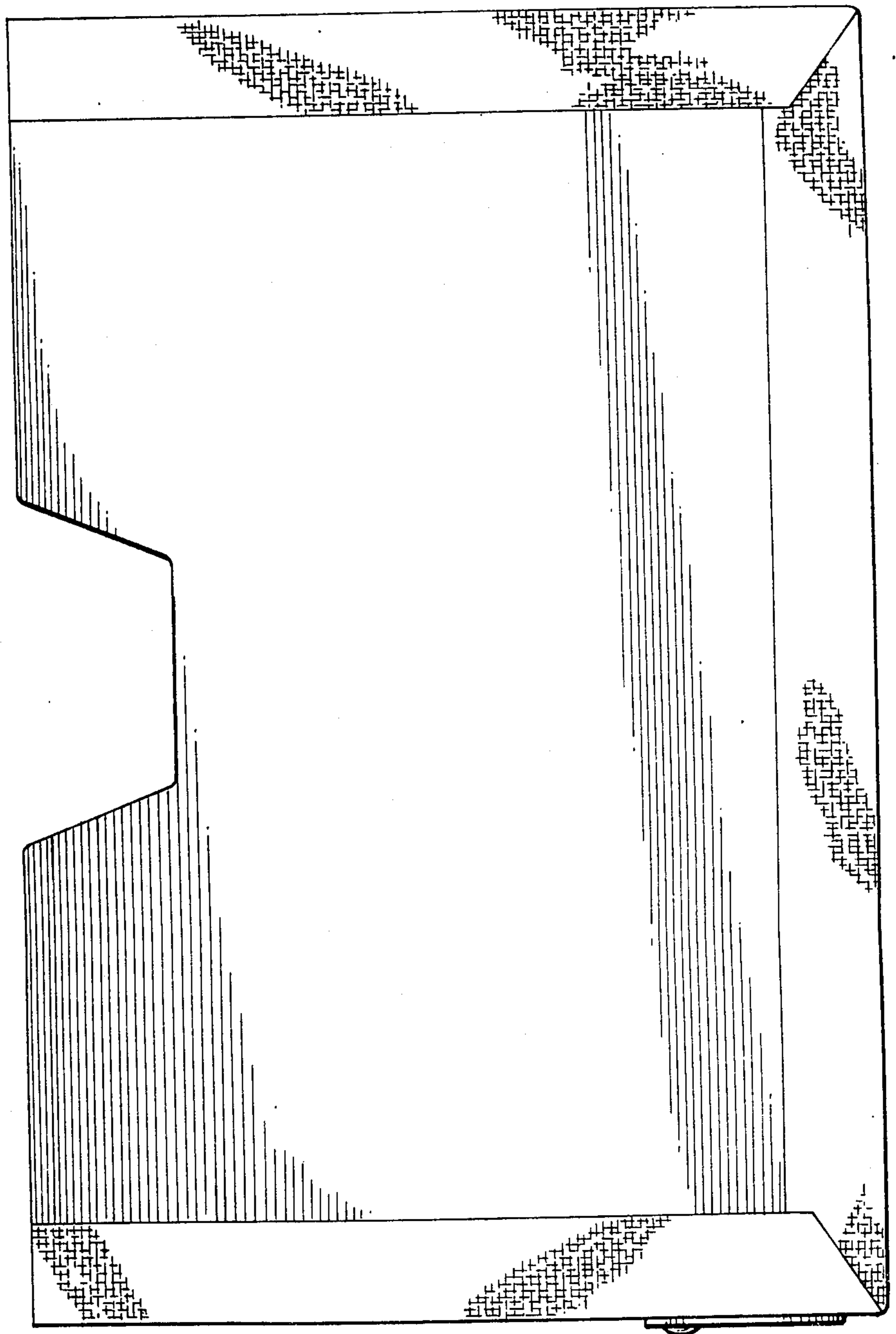

FIG. 3



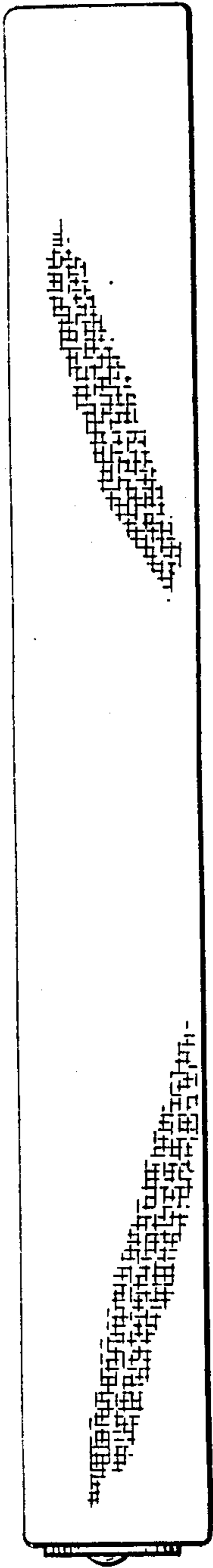

FIG. 4

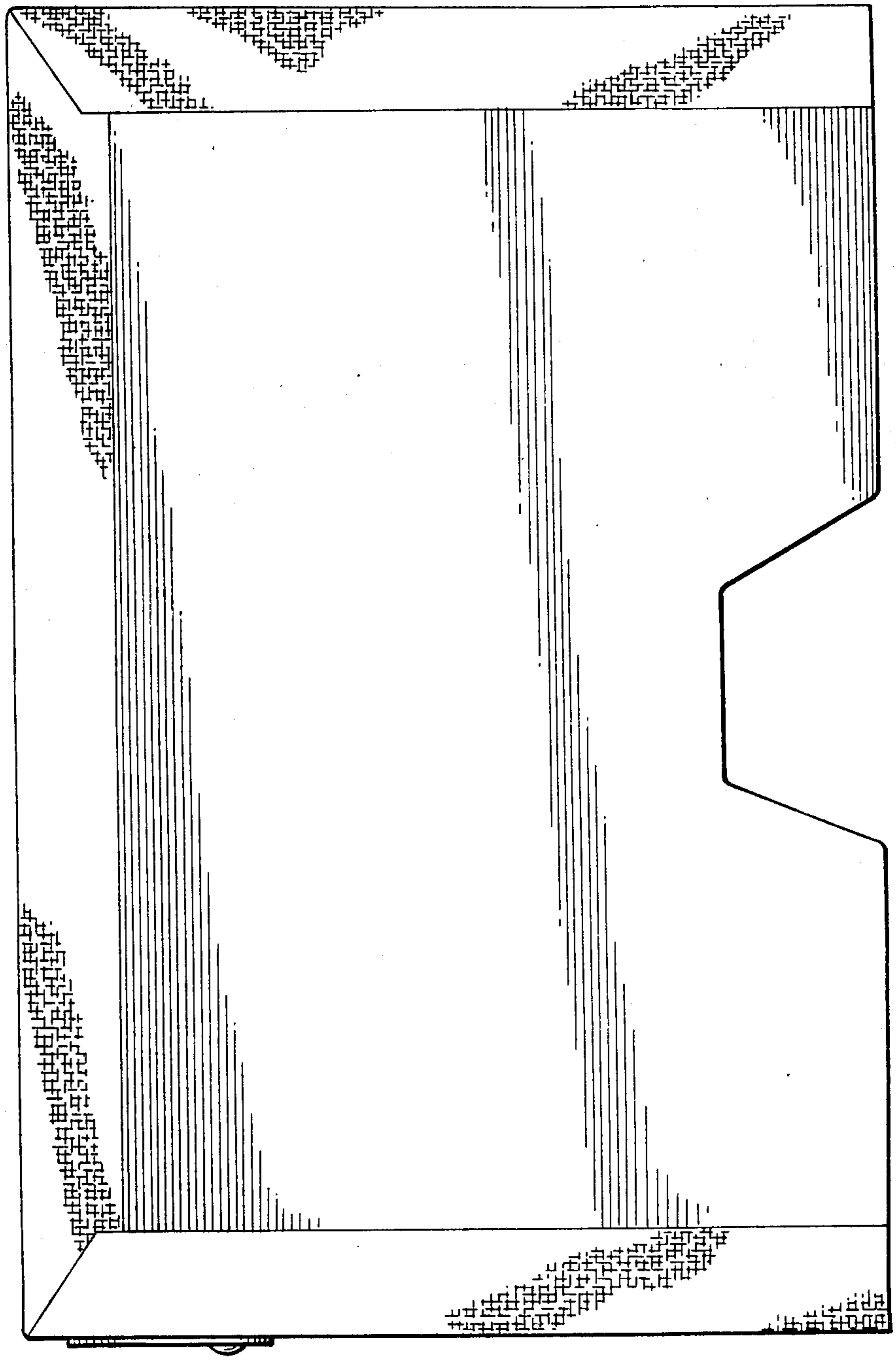

FIG. 5

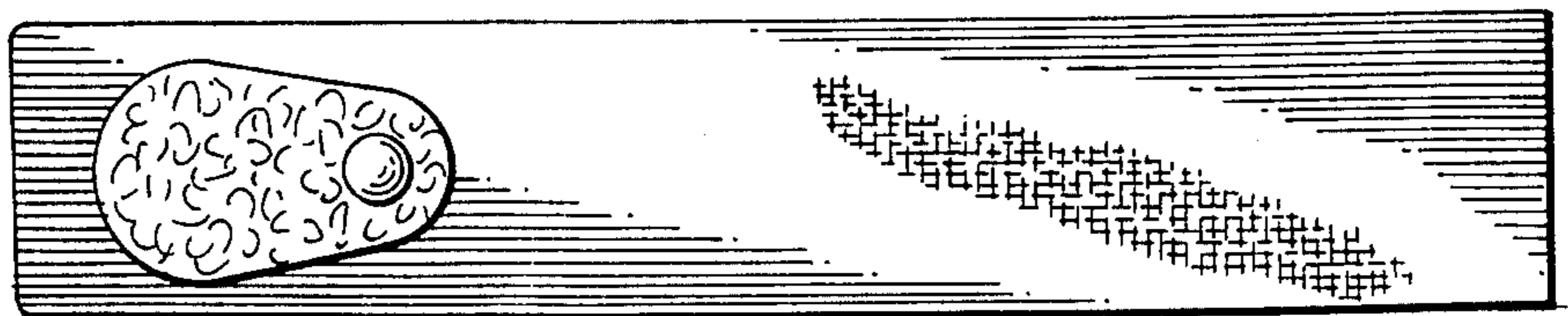

FIG. 6

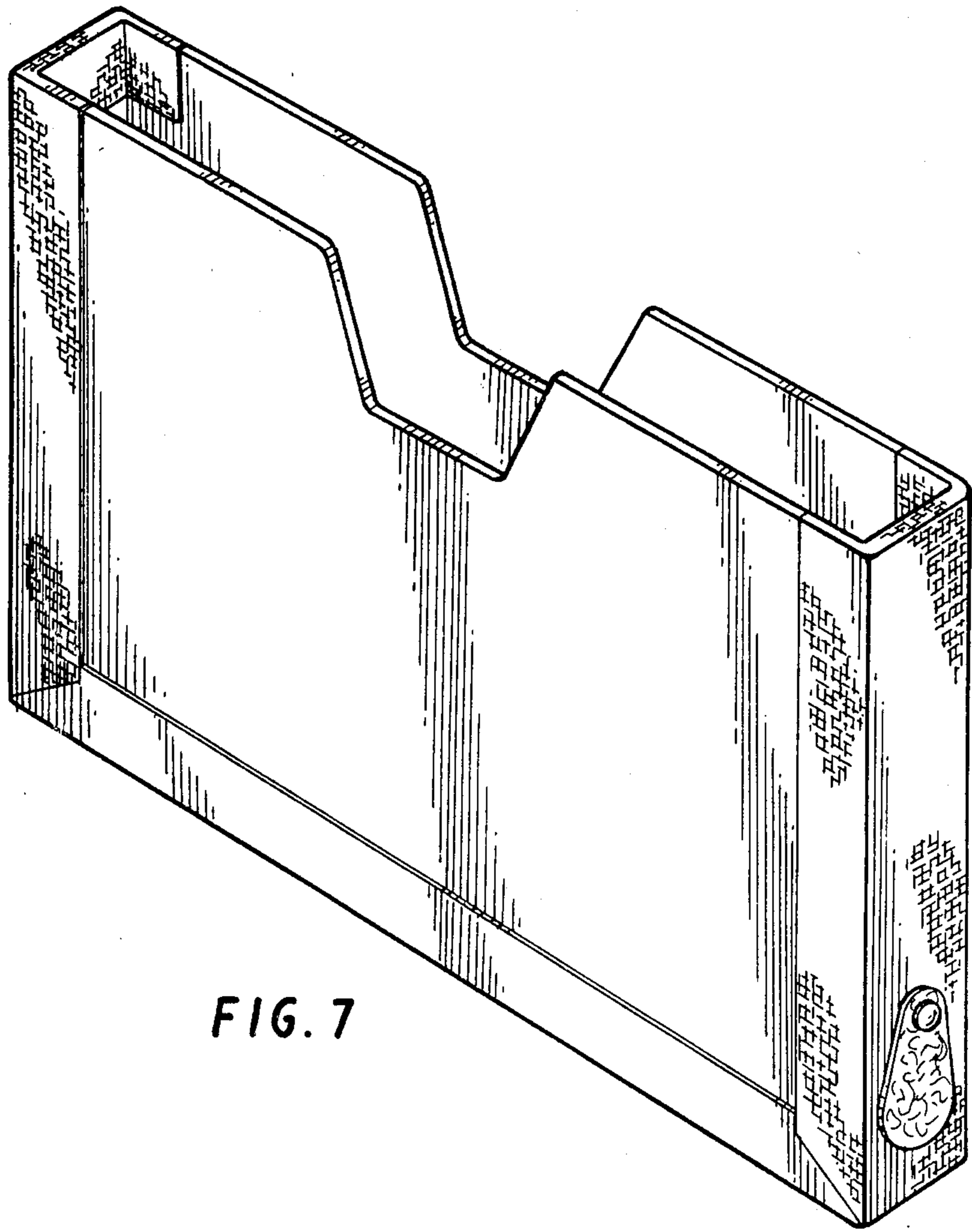

FIG. 7