

[54] **PLIERS**

[75] **Inventors:** Hans O. Himbert; Bengt E. Palmgren; Hakan Bergkvist, all of Bromma, Sweden

[73] **Assignee:** AB Bahco Verktyg, Sweden

[**] **Term:** 14 Years

[21] **Appl. No.:** 898,186

[22] **Filed:** Aug. 20, 1986

[30] **Foreign Application Priority Data**

Feb. 28, 1986 [SE] Sweden 86-0514

[52] **U.S. Cl.** D8/52; D8/22

[58] **Field of Search** D8/51-52, D8/55-56, 106; 81/300, 302, 305-306, 315-316, 324, 330, 341, 343, 355, 381, 415, 418; 7/125

[56] **References Cited**

U.S. PATENT DOCUMENTS

D. 258,930 4/1981 Wahlberg D8/52 X

OTHER PUBLICATIONS

Utica Tool catalogue, No. 639 (1965), No. 506, "Rib--Joint Heavy Duty Pliers", p. 12.

Ingersoll-Rand Proto Professional Tools catalogue (1980), No. DD, "Power-Track Multi-Purpose Pliers", p. 100.

Primary Examiner—Wallace R. Burke

Assistant Examiner—Brian N. Vinson

Attorney, Agent, or Firm—Stevens, Davis, Miller & Mosher

[57] **CLAIM**

The ornamental design for pliers, as shown and described.

DESCRIPTION

FIG. 1 is a top and one side perspective view of the pliers showing our new design;

FIG. 2 is a bottom and opposite side perspective view thereof;

FIG. 3 is a top plan view thereof;

FIG. 4 is a front elevational view thereof;

FIG. 5 is a rear elevational view thereof; and

FIG. 6 is a side elevational view thereof, the side opposite being a mirror image.

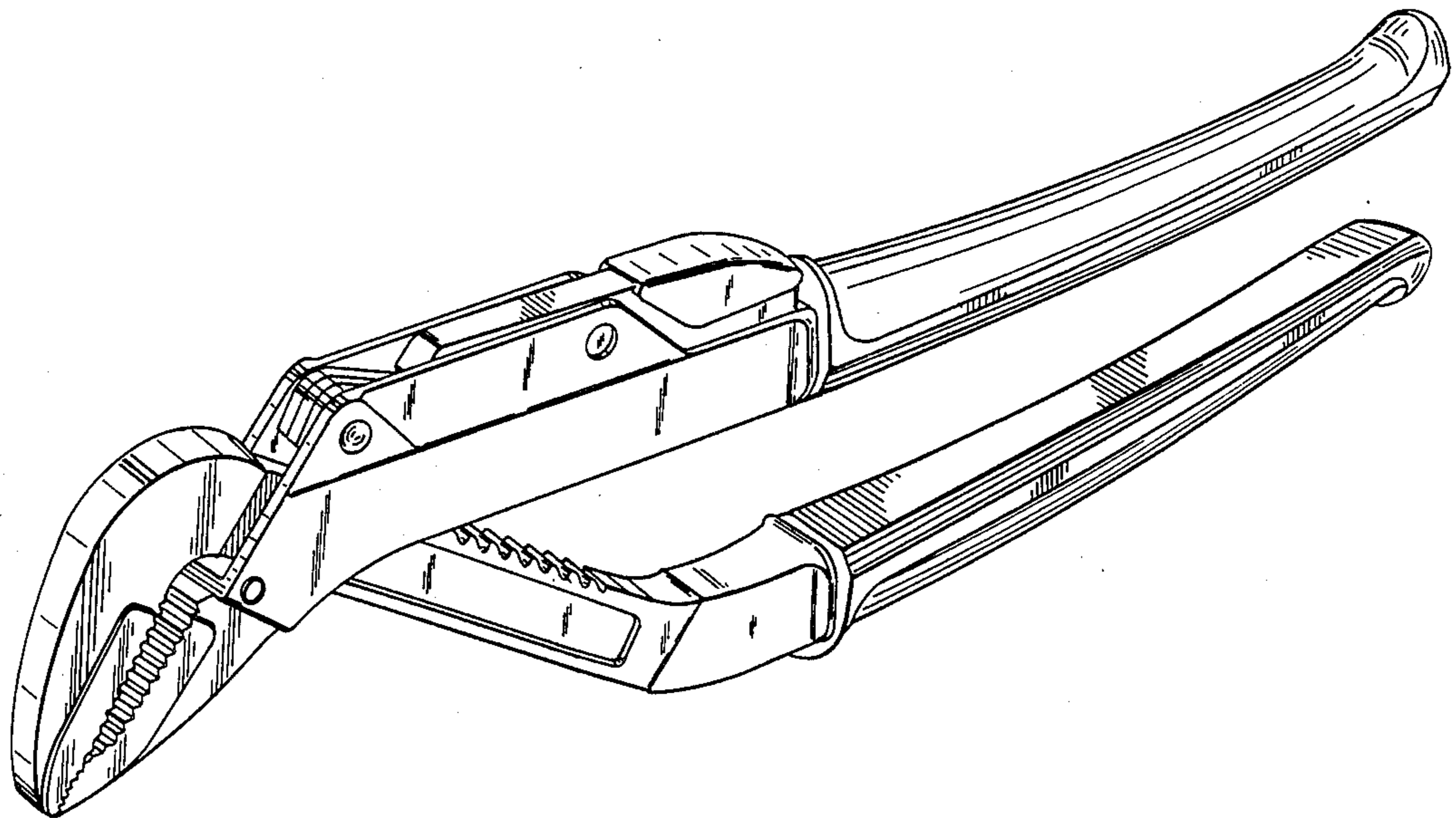

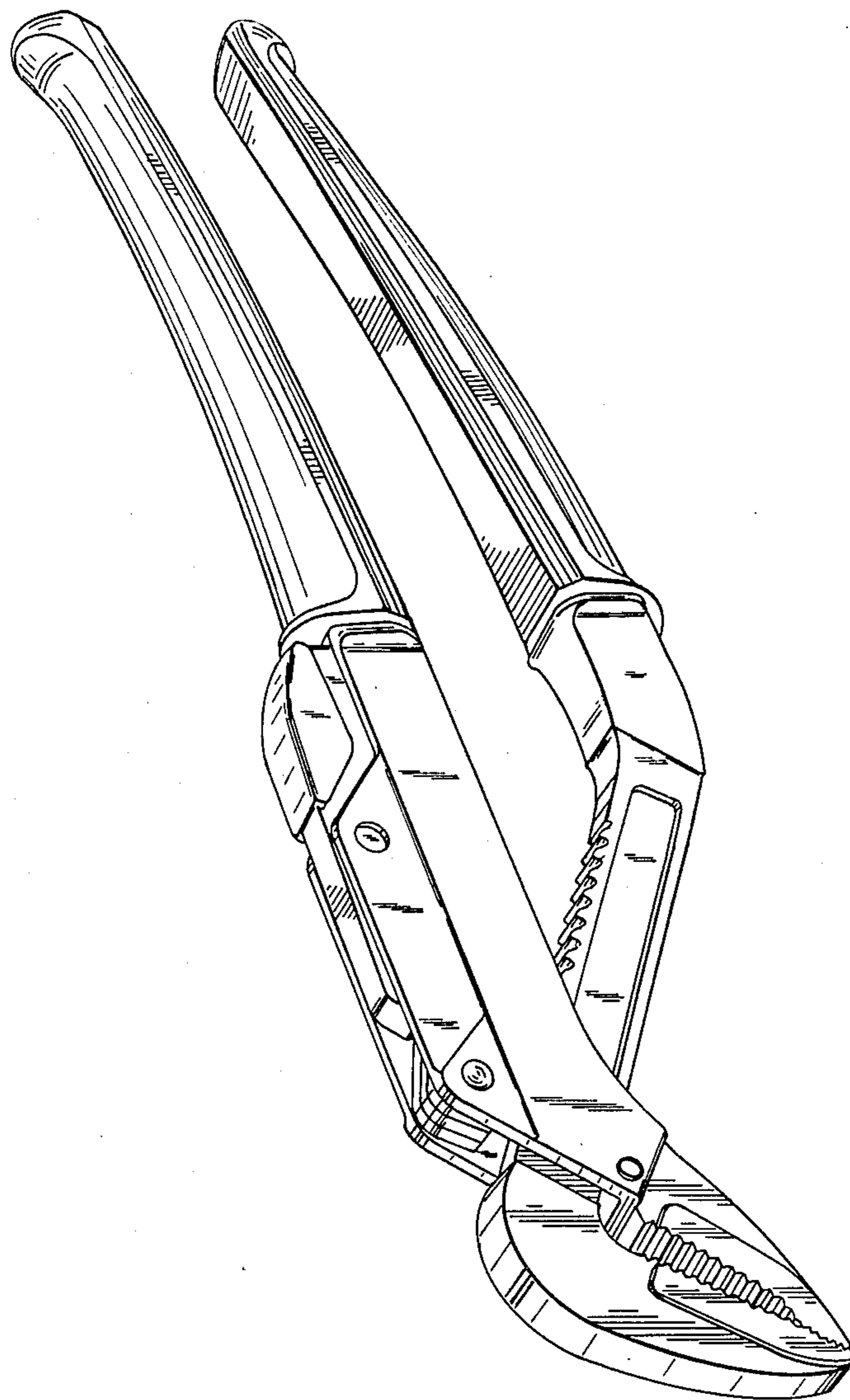

FIG. 1

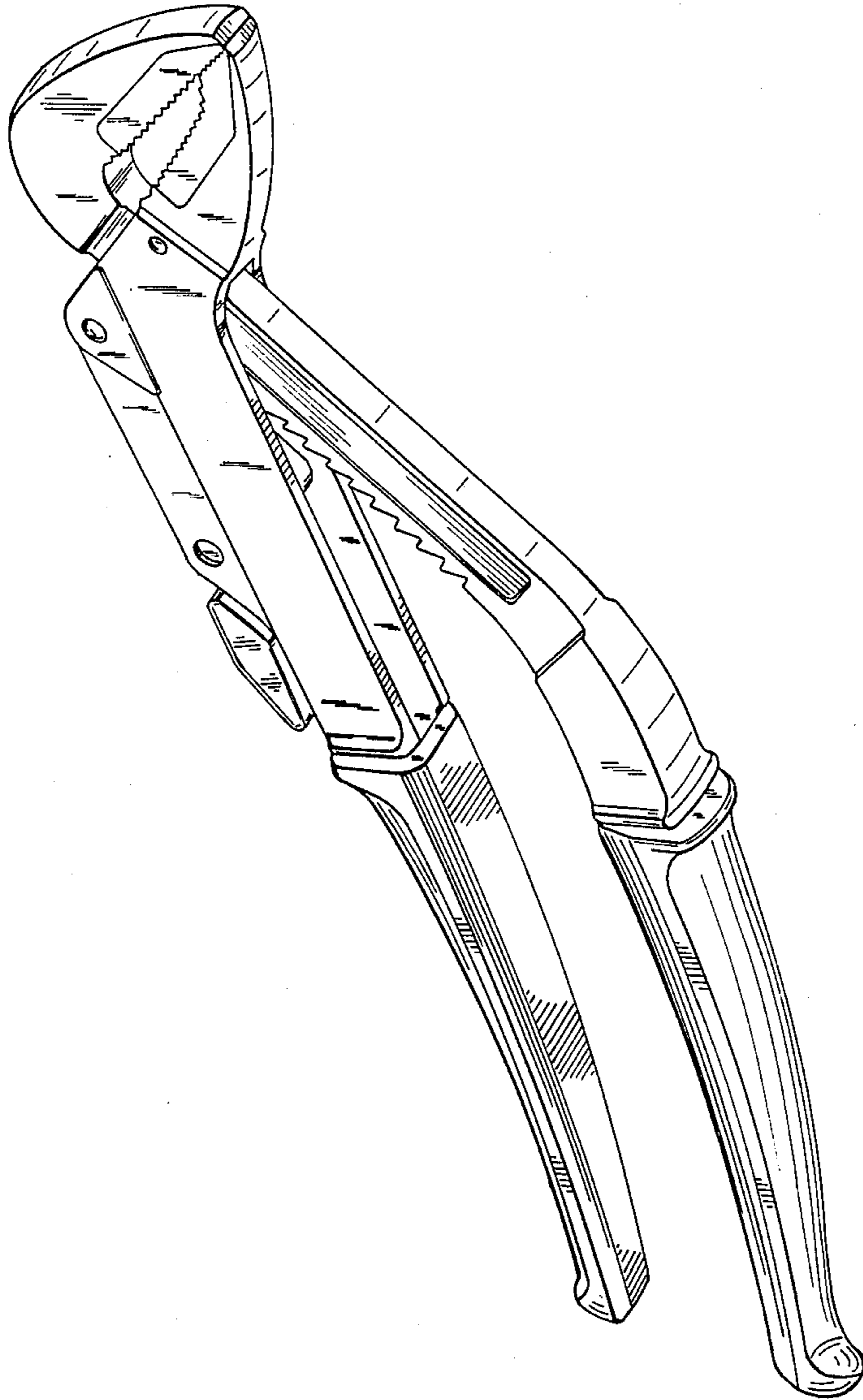

FIG. 2

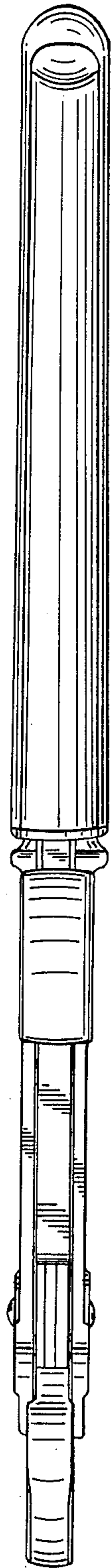

FIG. 3

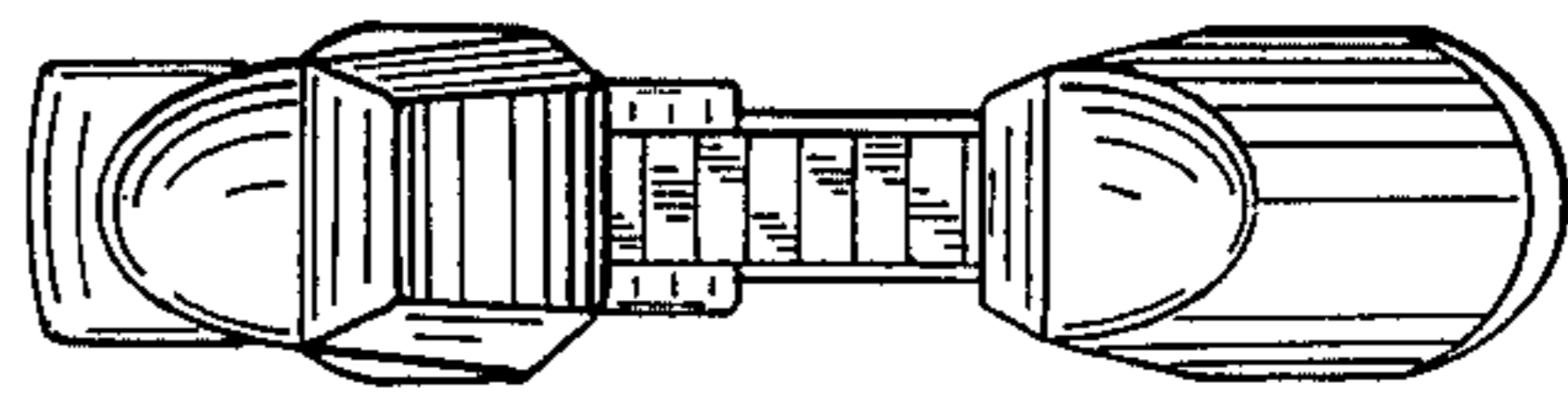

FIG. 5

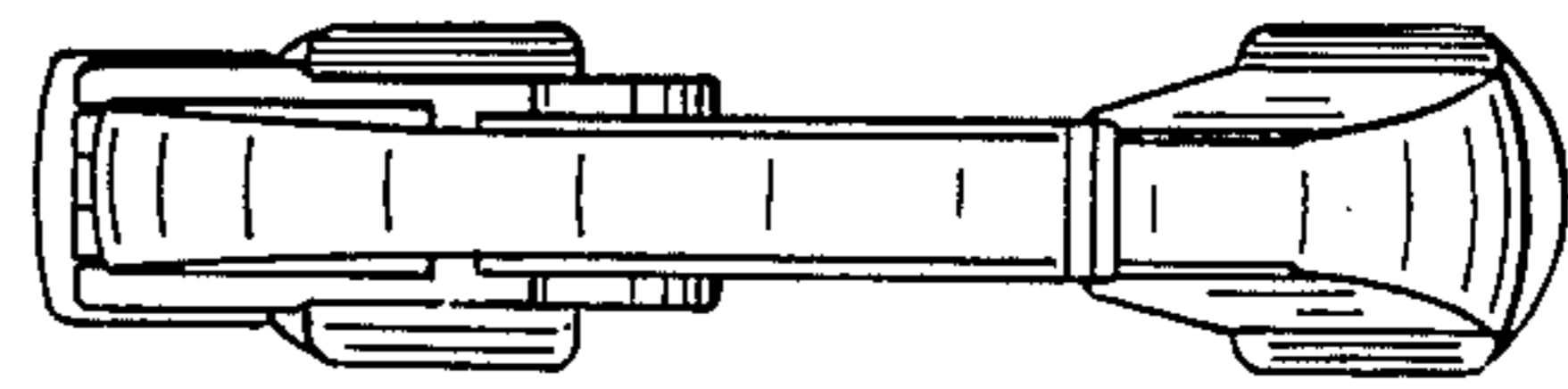

FIG. 4

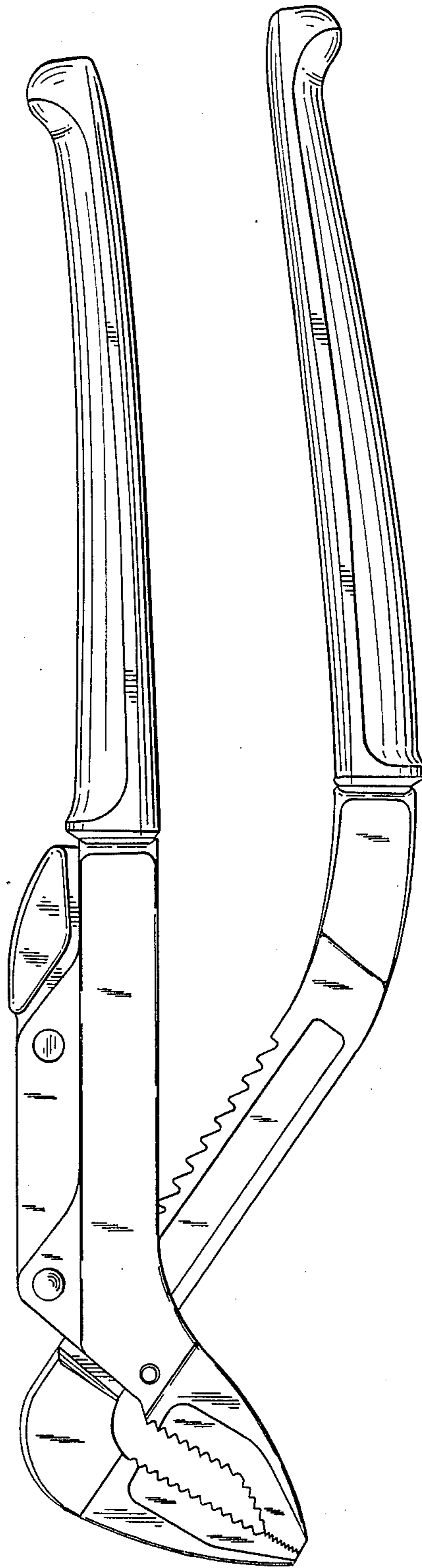

FIG. 6