

[54] AXIAL FAN

[76] Inventor: **Manabu Shiraki**, 4451-182
Shimotsuruma, Yamato-shi,
Kanagawa-ken, Japan

[**] Term: **14 Years**

[21] Appl. No.: **881,205**

[22] Filed: **Jul. 2, 1986**

[30] **Foreign Application Priority Data**

May 6, 1986 [JP] Japan 61-16944
May 6, 1986 [JP] Japan 61-16945

[52] U.S. Cl. **D23/379; D23/370;**
D23/371; D23/385

[58] Field of Search **D23/370-371,**
D23/379, 383, 385; 417/353; 415/213 C, 219 B

[56] **References Cited**

U.S. PATENT DOCUMENTS

D. 187,699 4/1960 van Rijn D23/379
D. 209,250 11/1967 Grad D23/379
D. 231,355 4/1974 Papst D23/377
3,204,546 9/1965 Krell 415/121 G
4,225,285 9/1980 Sturm 415/213 C X
4,482,302 11/1984 Grignon 415/213 C X
4,564,335 1/1986 Harmsen et al. 415/213 C X
4,568,243 2/1986 Schubert et al. 415/219 R X

Primary Examiner—Wallace R. Burke

Assistant Examiner—Brian N. Vinson

Attorney, Agent, or Firm—Frishauf, Holtz, Goodman &
Woodward

[57] **CLAIM**

The ornamental design for axial fan, substantially as shown and described.

DESCRIPTION

FIG. 1 is a front elevation of an axial fan showing a first embodiment of my new design;
FIG. 2 is a rear elevation thereof;
FIG. 3 is a right side elevation thereof;
FIG. 4 is a left side elevation thereof;
FIG. 5 is a top plan view thereof;
FIG. 6 is a bottom plan view thereof;
FIG. 7 is a perspective view thereof;
FIG. 8 is a front elevation of an axial fan showing a second embodiment of my new design;
FIG. 9 is a rear elevation thereof;
FIG. 10 is a right side elevation thereof;
FIG. 11 is a left side elevation thereof;
FIG. 12 is a top plan view thereof;
FIG. 13 is a bottom plan view thereof;
FIG. 14 is a perspective view thereof;
FIG. 15 is a front elevation of an axial fan showing a third embodiment of my new design;
FIG. 16 is a rear elevation thereof;
FIG. 17 is a right side elevation thereof;
FIG. 18 is a left side elevation thereof;
FIG. 19 is a top plan view thereof;
FIG. 20 is a bottom plan view thereof;
FIG. 21 is a perspective view thereof;
FIG. 22 is a front elevation of an axial fan showing a fourth embodiment of my new design;
FIG. 23 is a rear elevation thereof;
FIG. 24 is a right side elevation thereof;
FIG. 25 is a left side elevation thereof;
FIG. 26 is a top plan view thereof;
FIG. 27 is a bottom plan view thereof; and
FIG. 28 is a perspective view thereof.

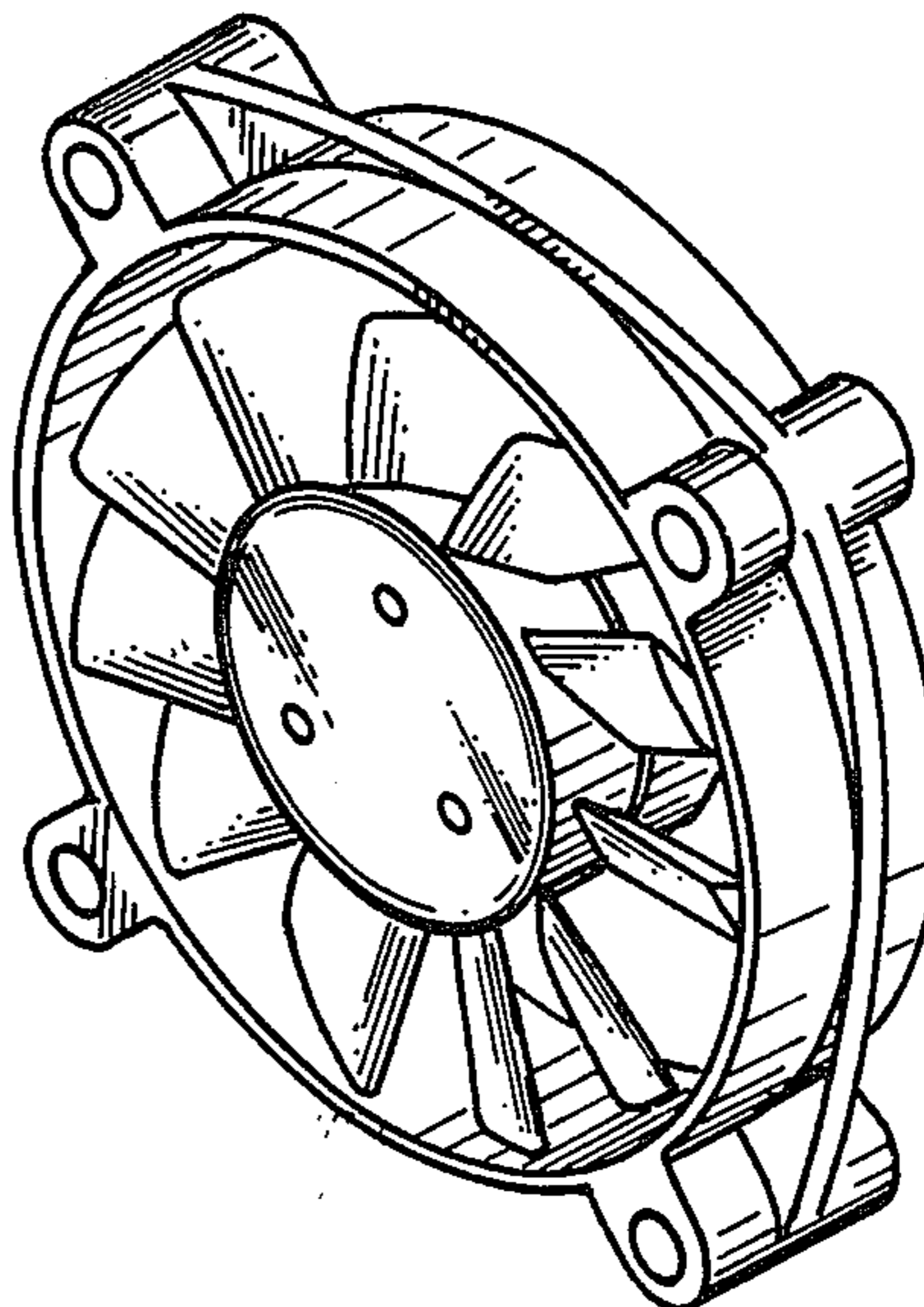
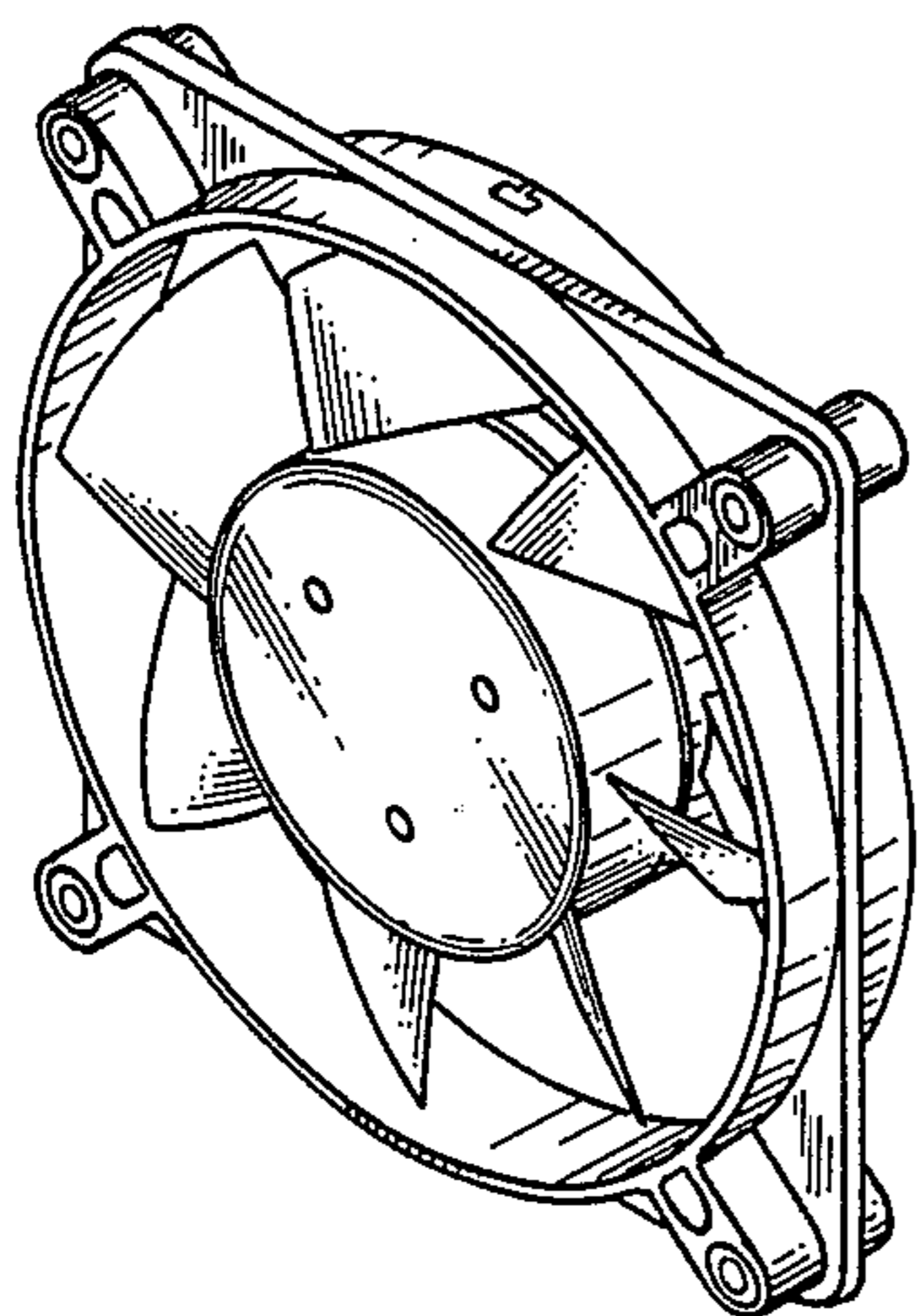

FIG. 1

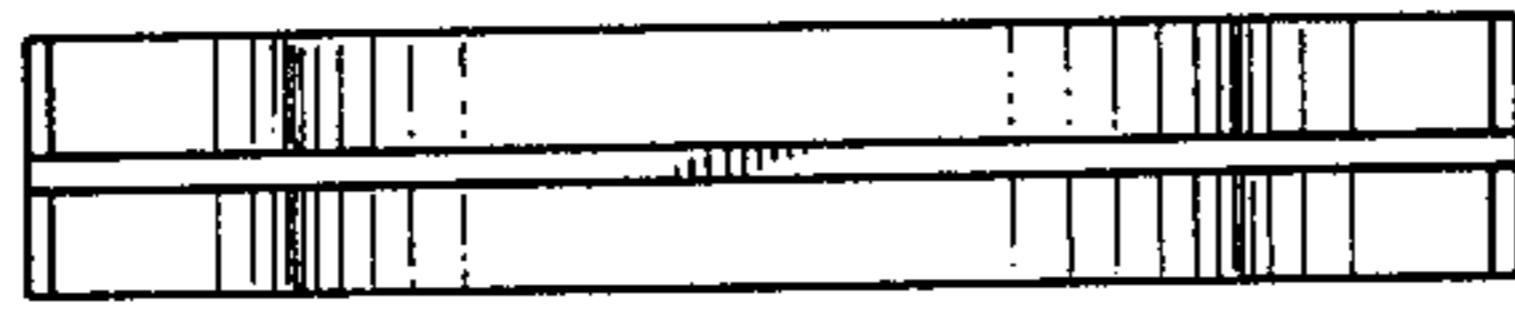

FIG. 2

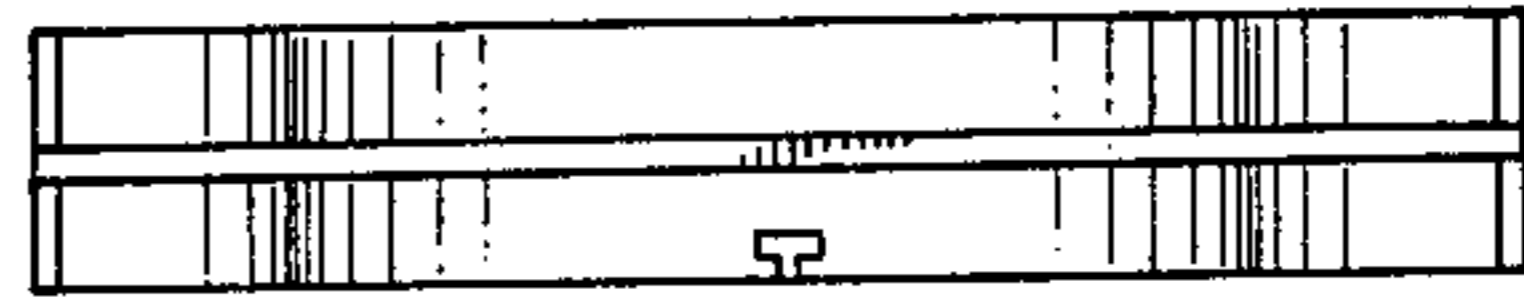

FIG. 3

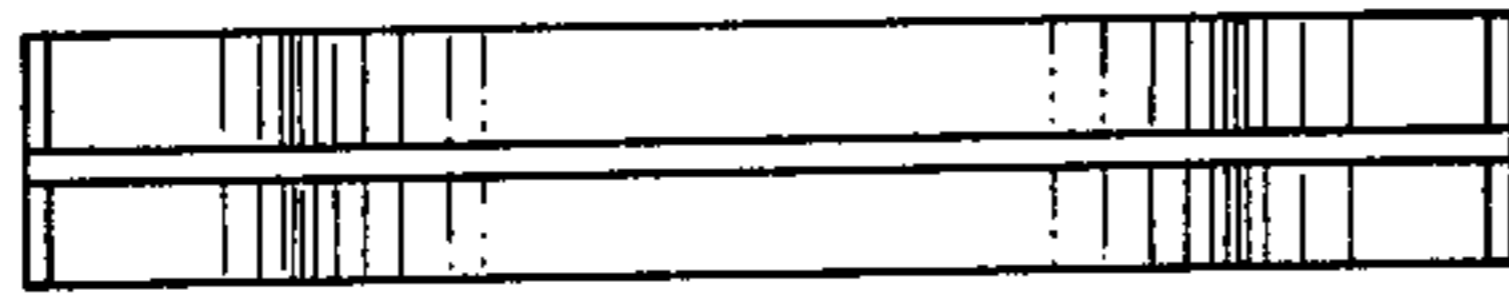

FIG. 4

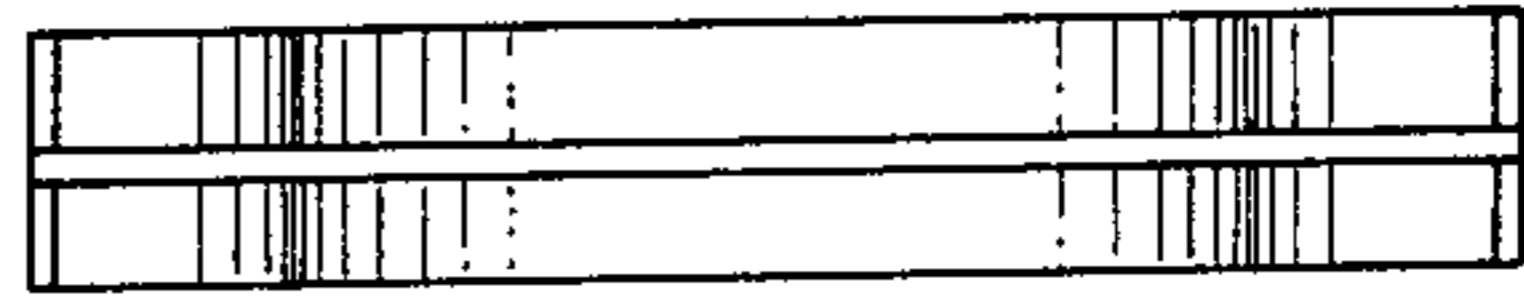

FIG. 5

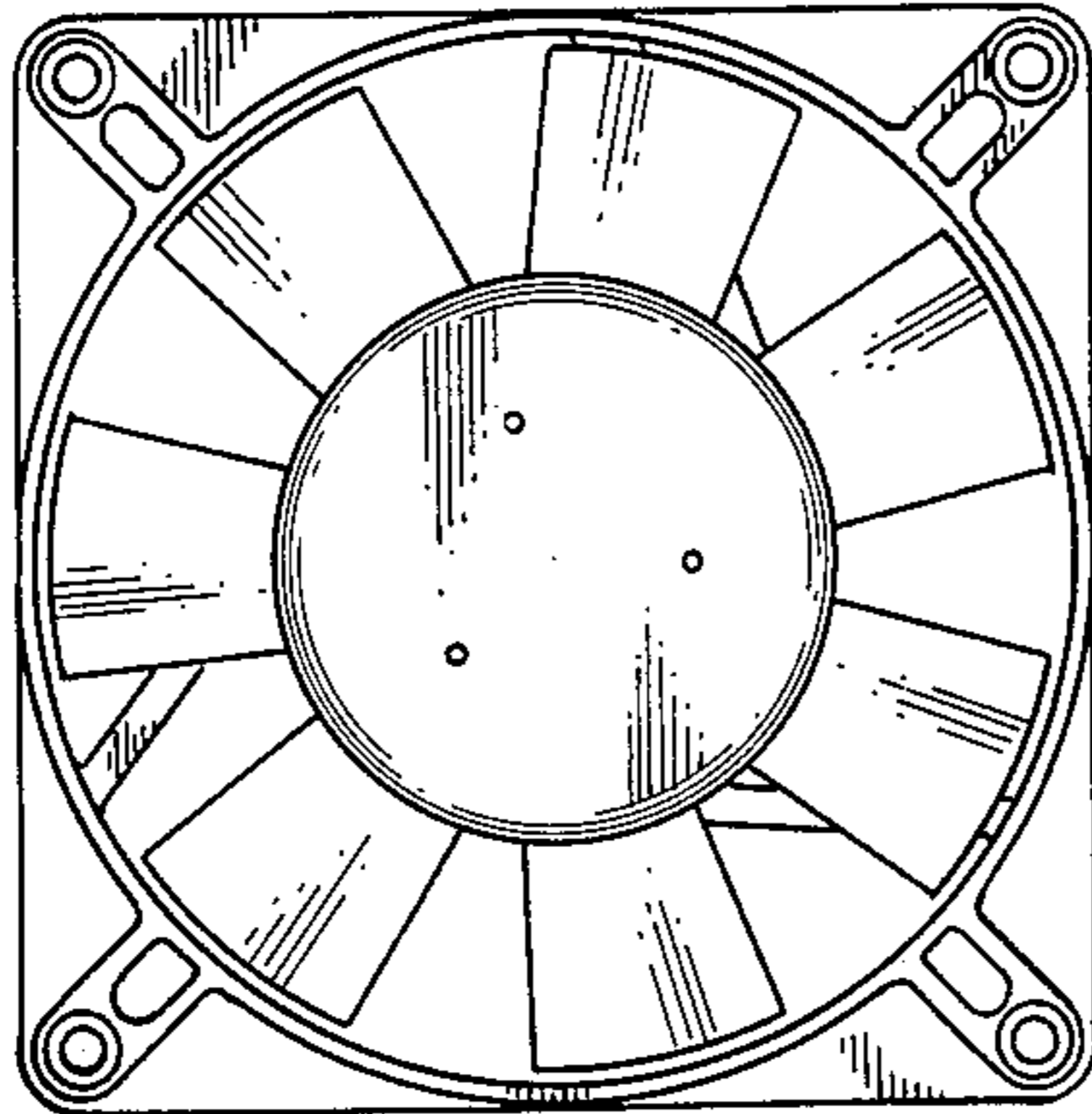

FIG. 6

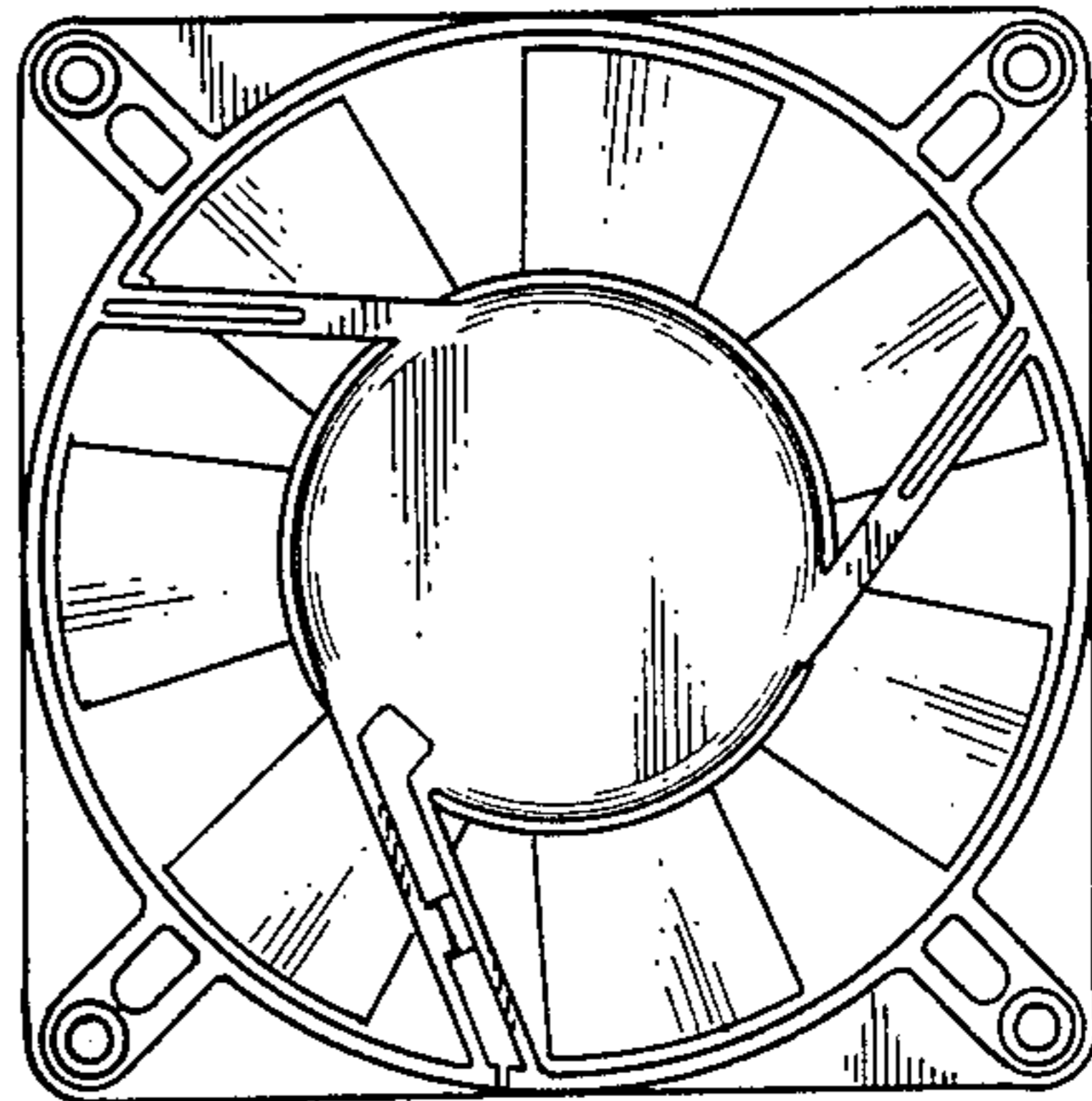

FIG. 7

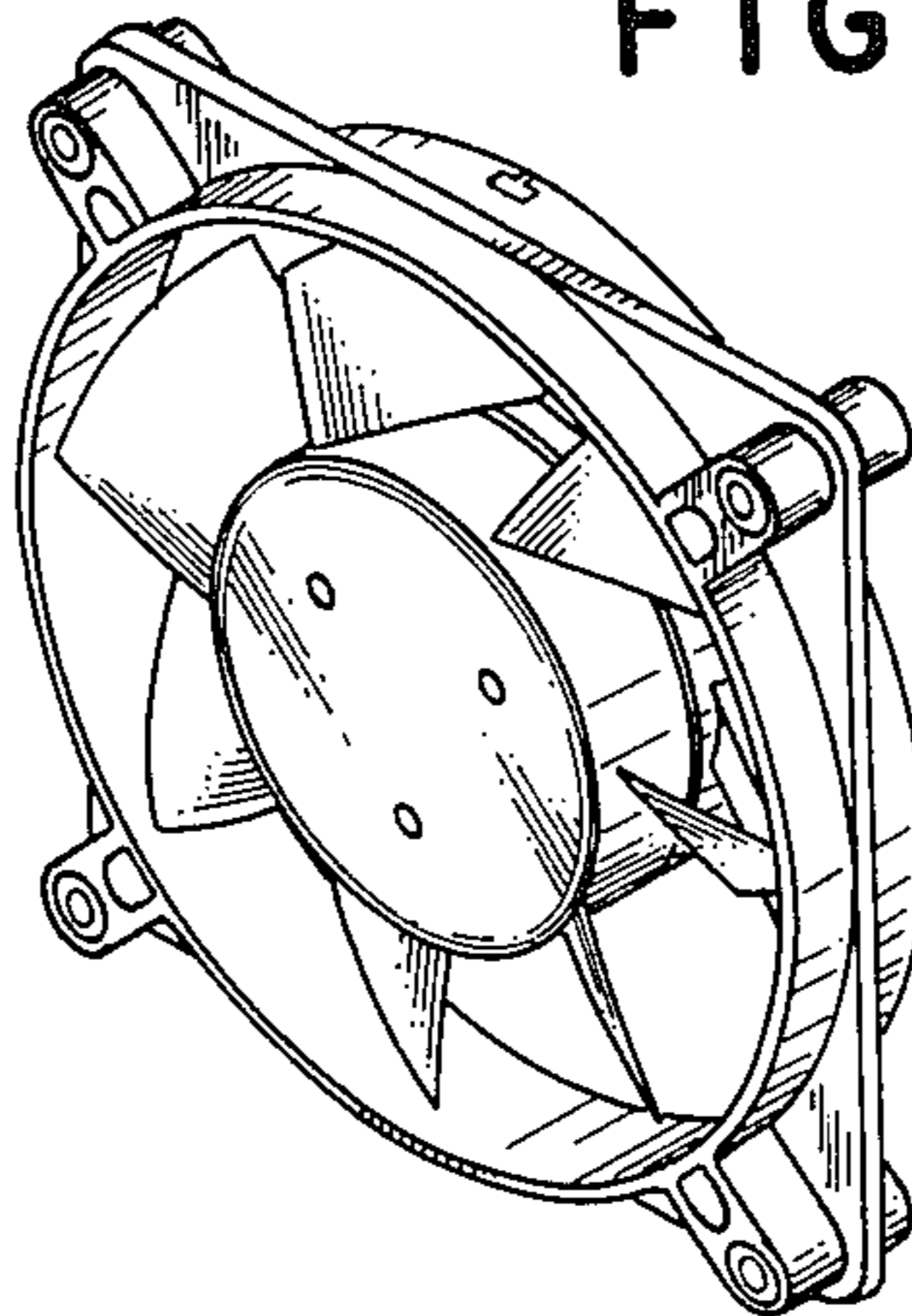

FIG. 8

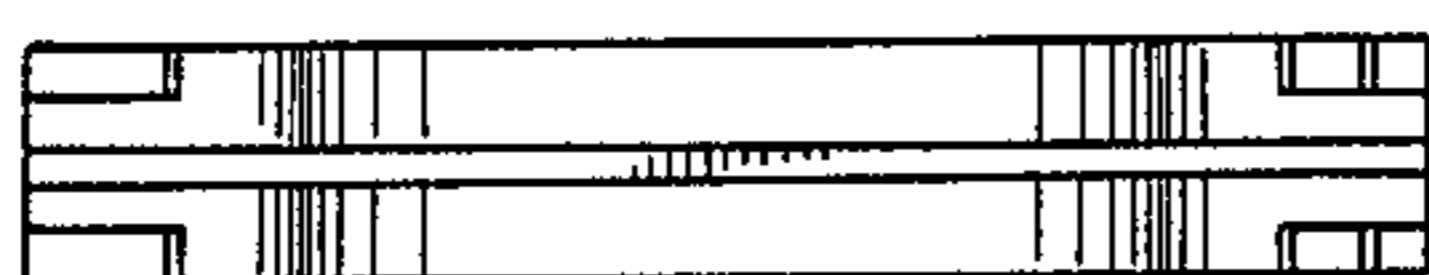

FIG. 9



FIG. 10

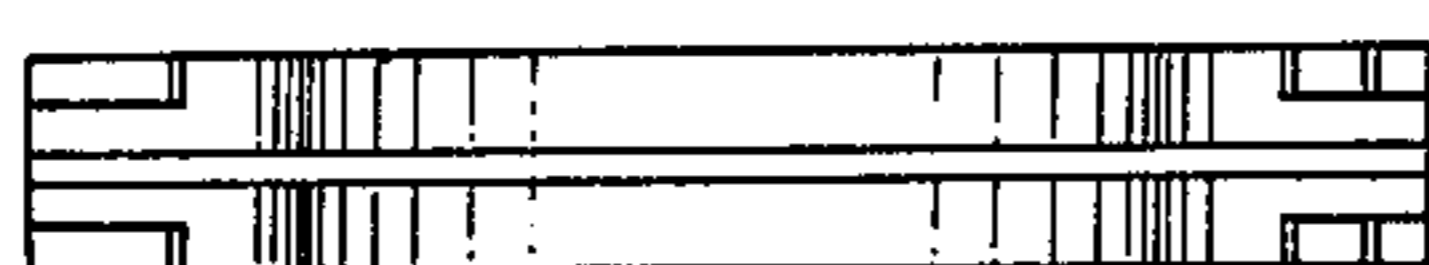

FIG. 11

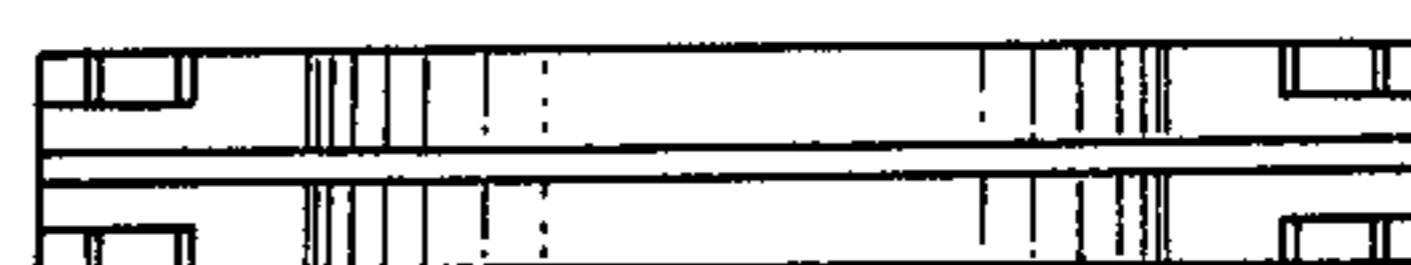

FIG. 12

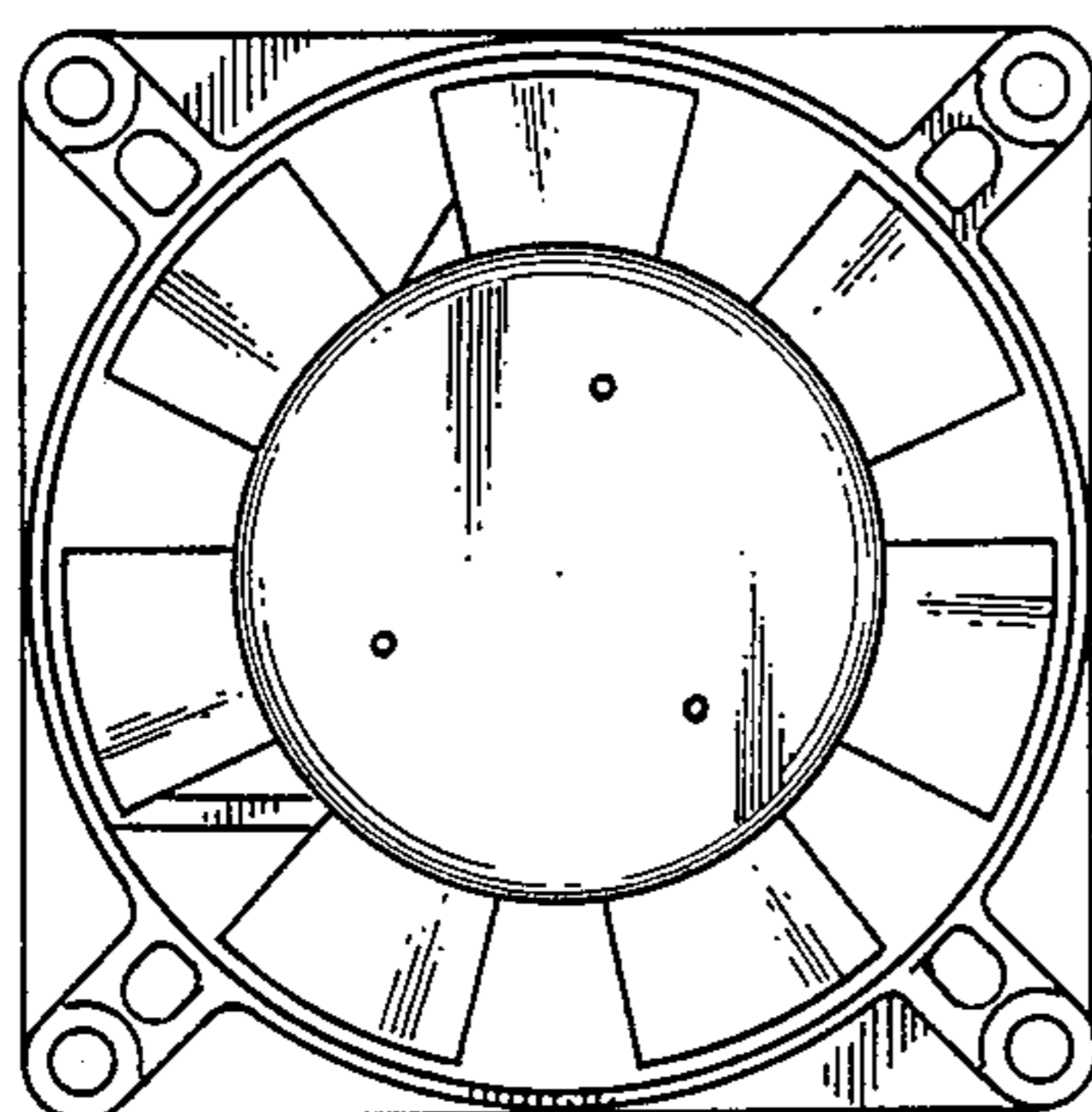

FIG. 13

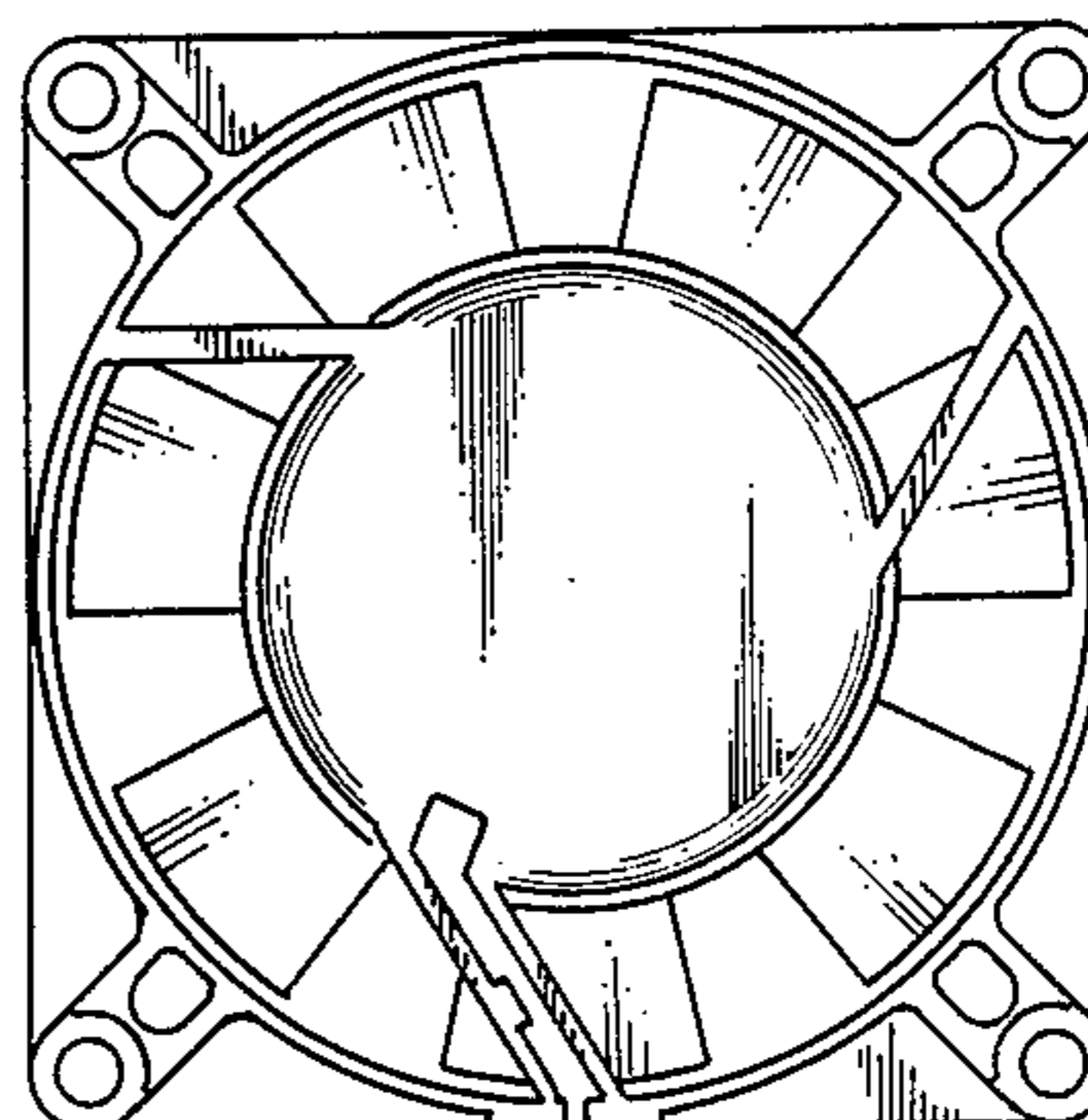

FIG. 14

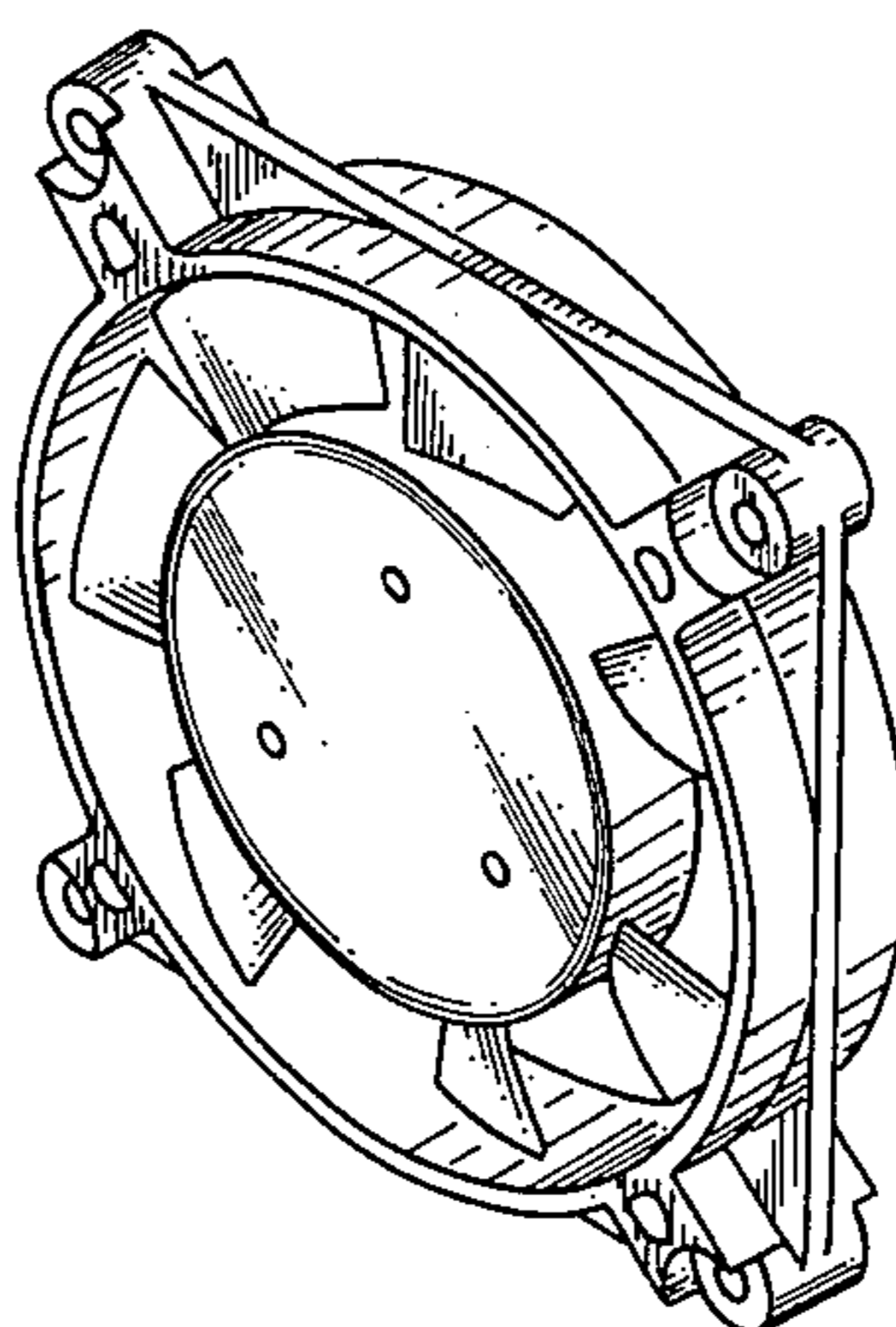

FIG. 15

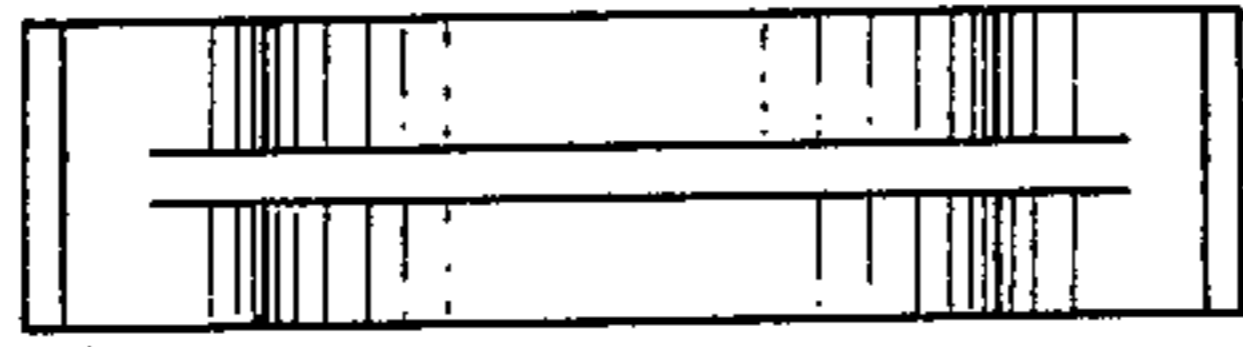

FIG. 16



FIG. 17

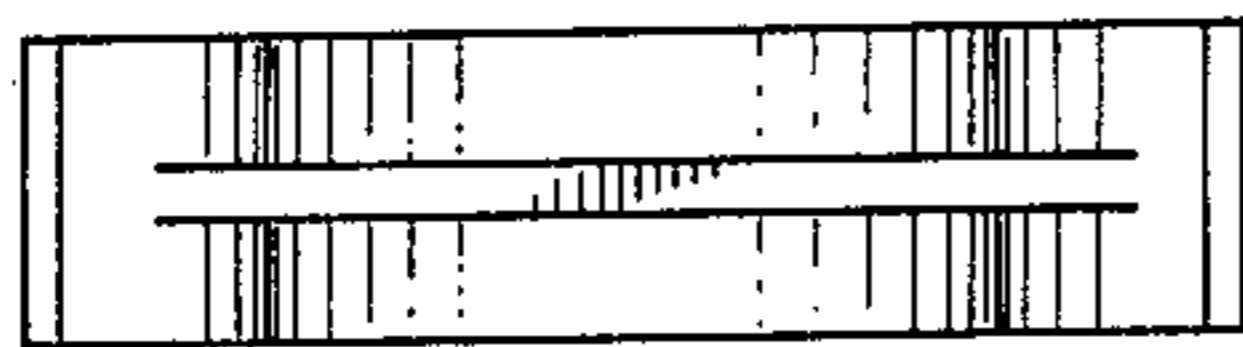

FIG. 18

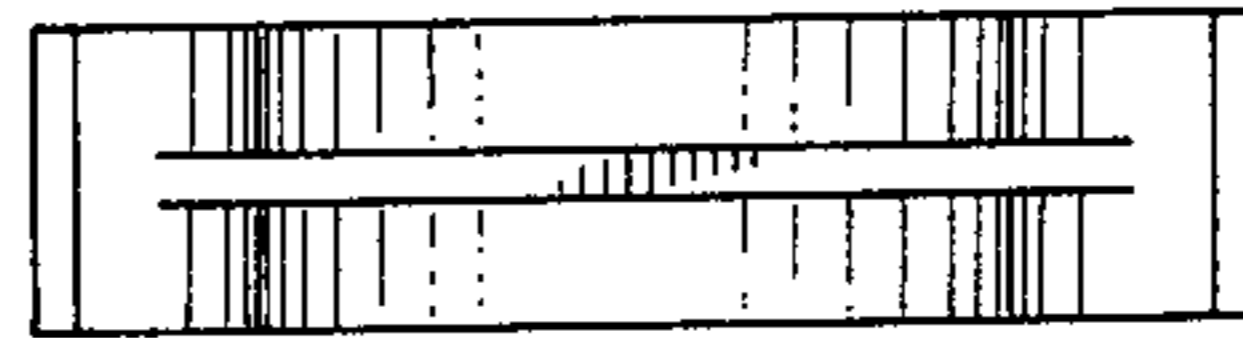

FIG. 19

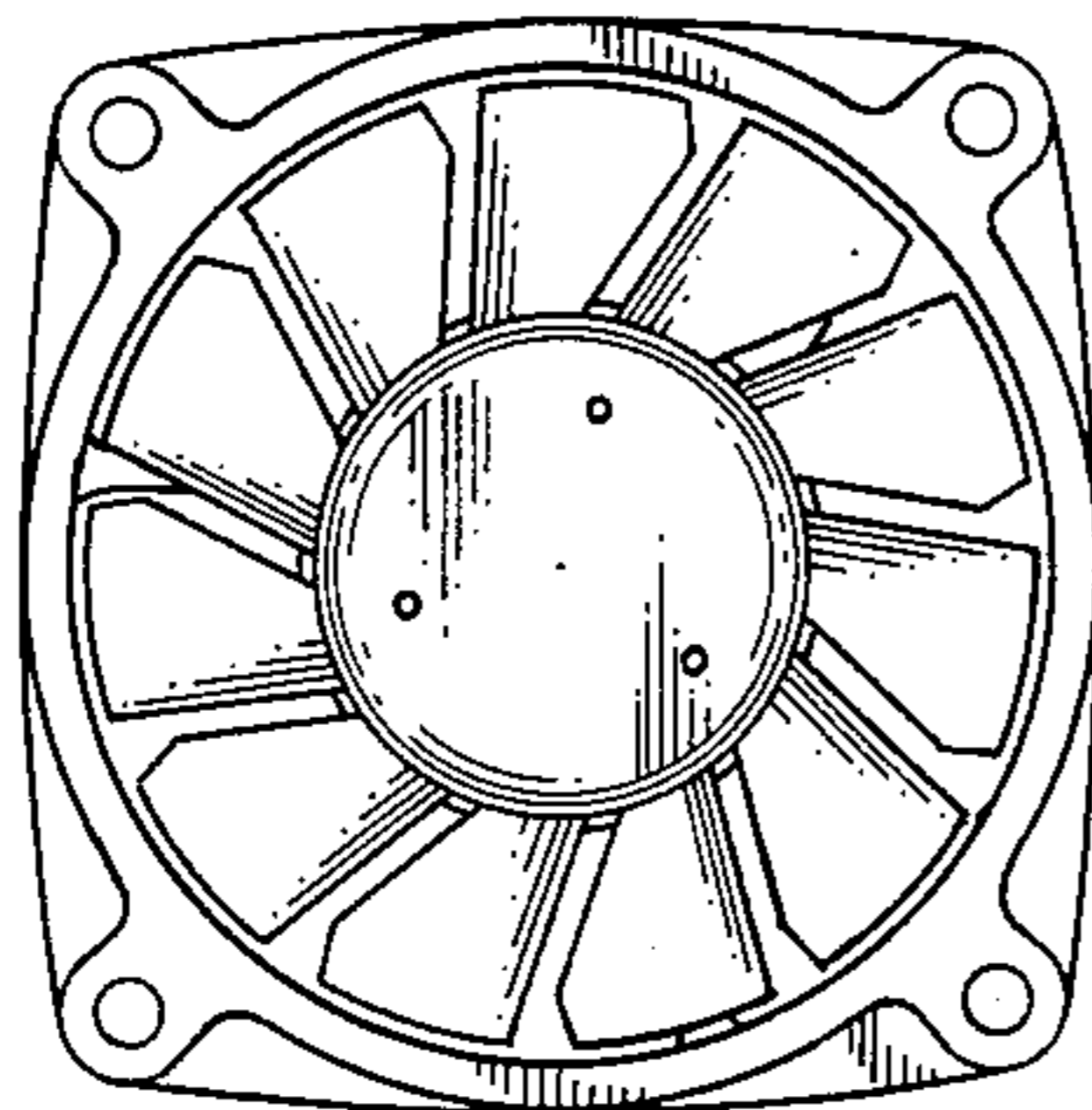

FIG. 20

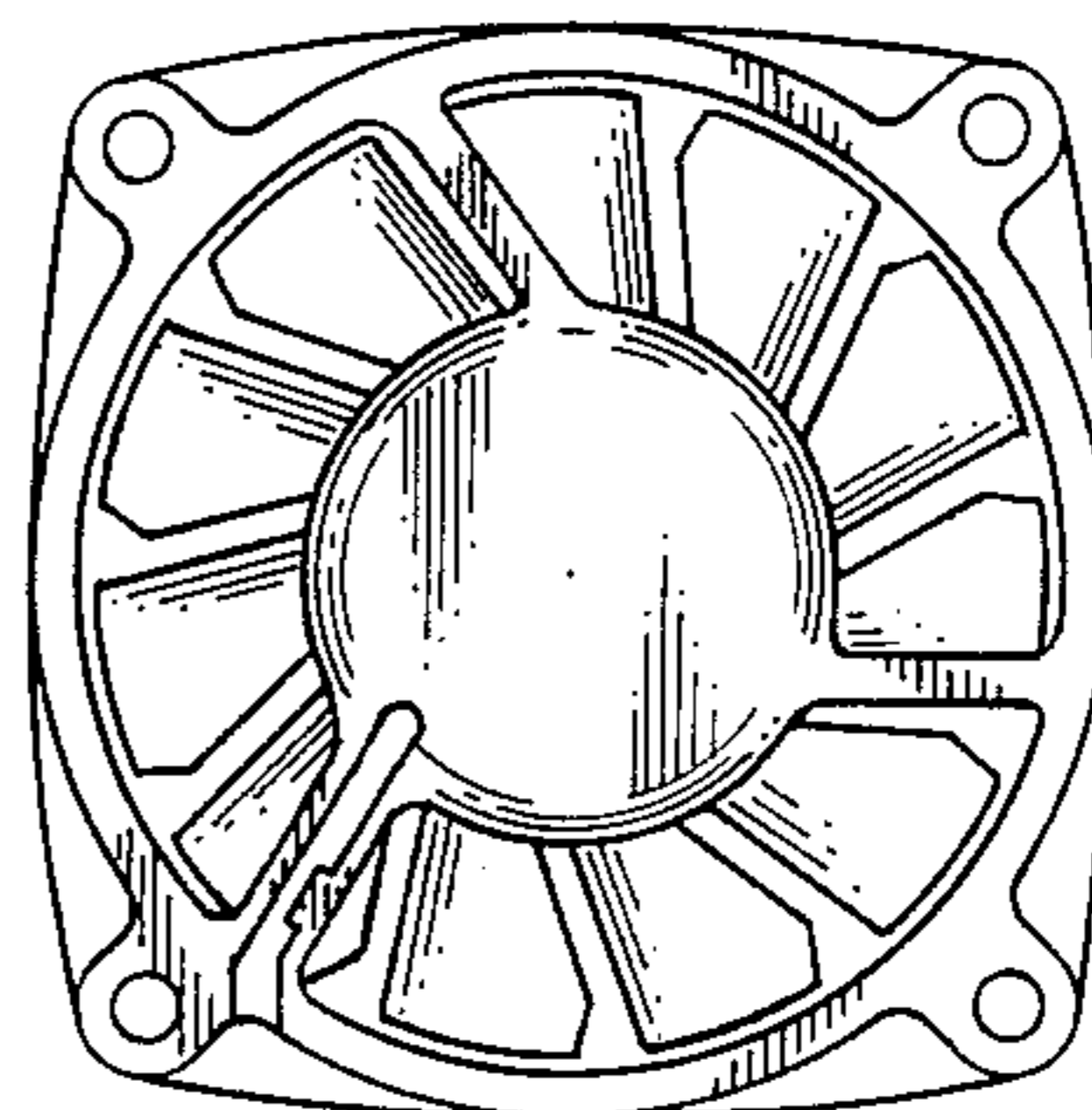

FIG. 21

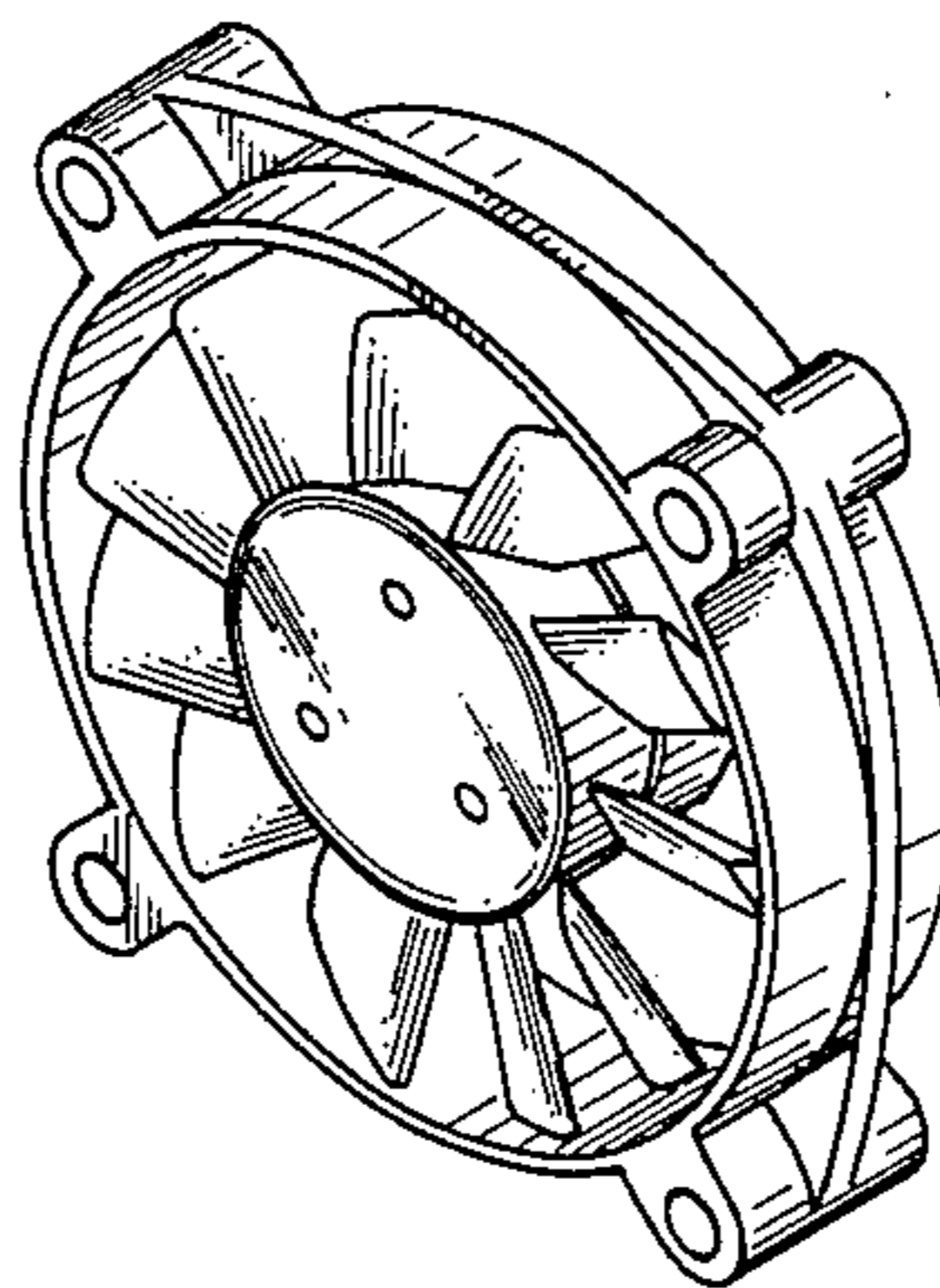

FIG. 22

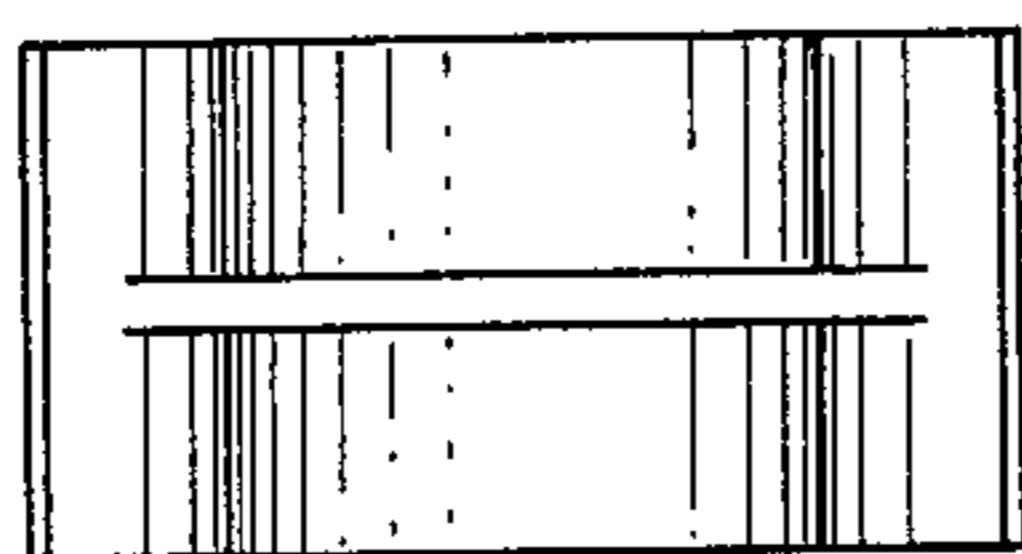

FIG. 23

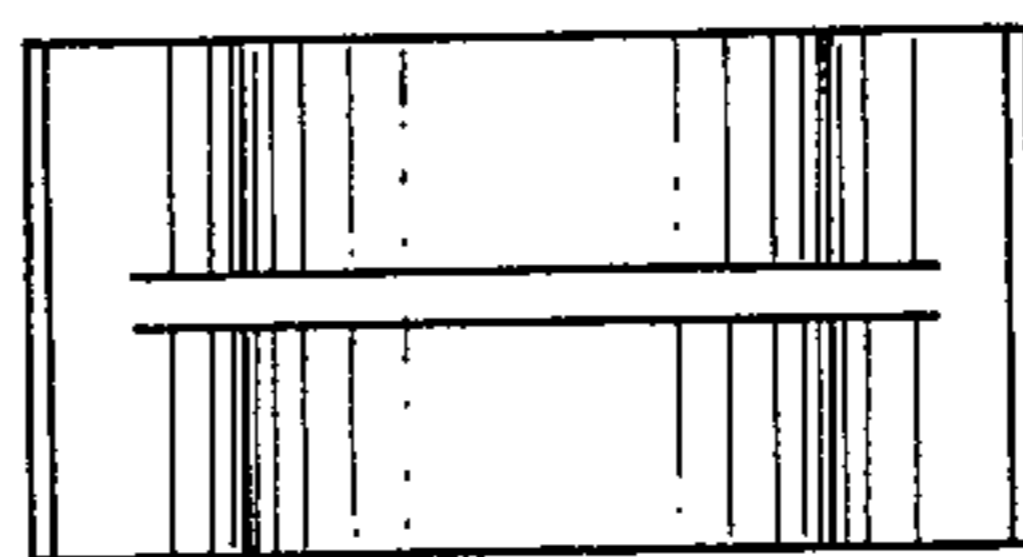

FIG. 24

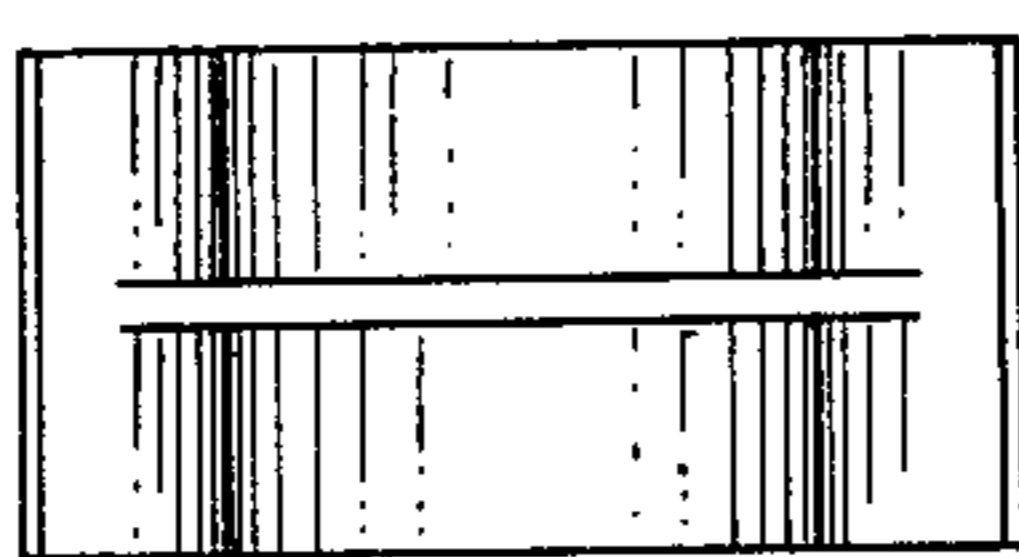

FIG. 25

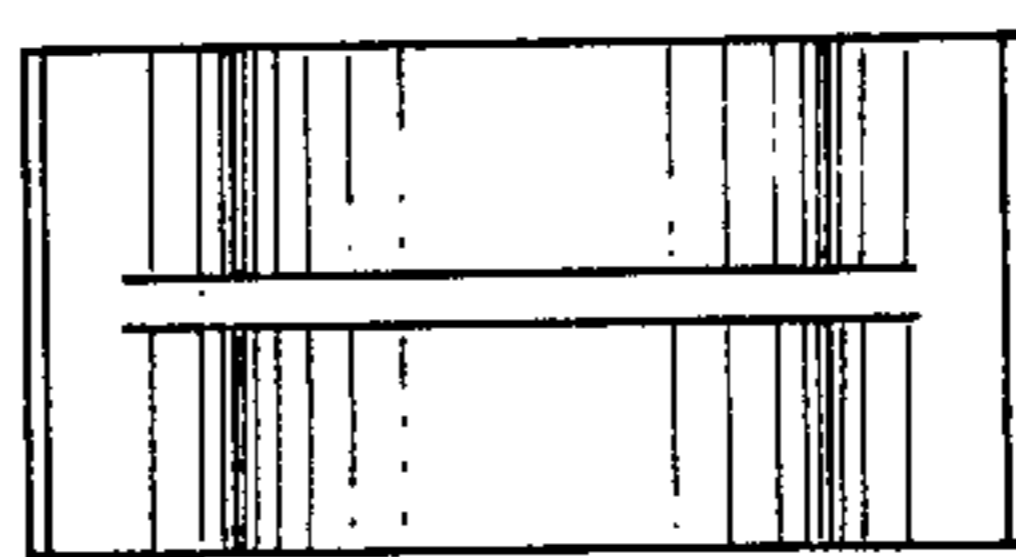

FIG. 26

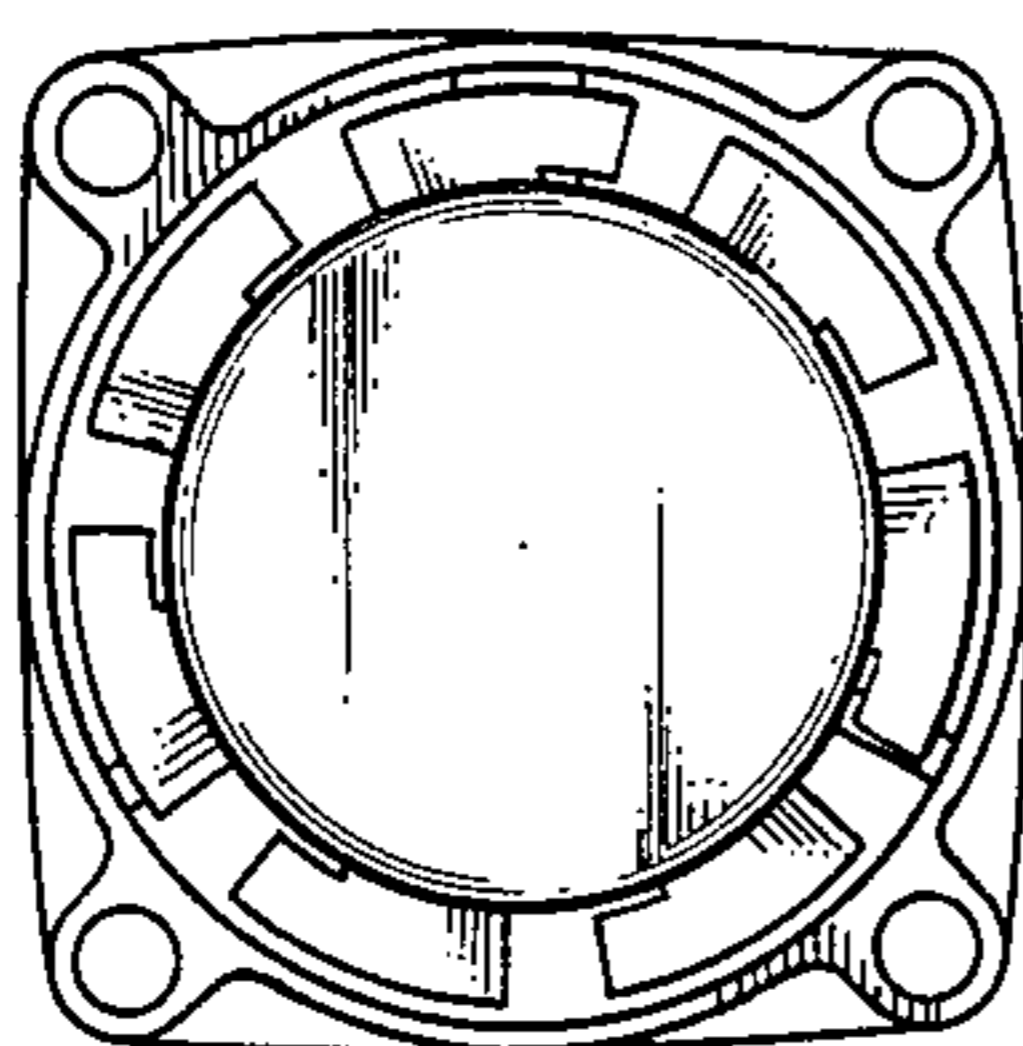

FIG. 27

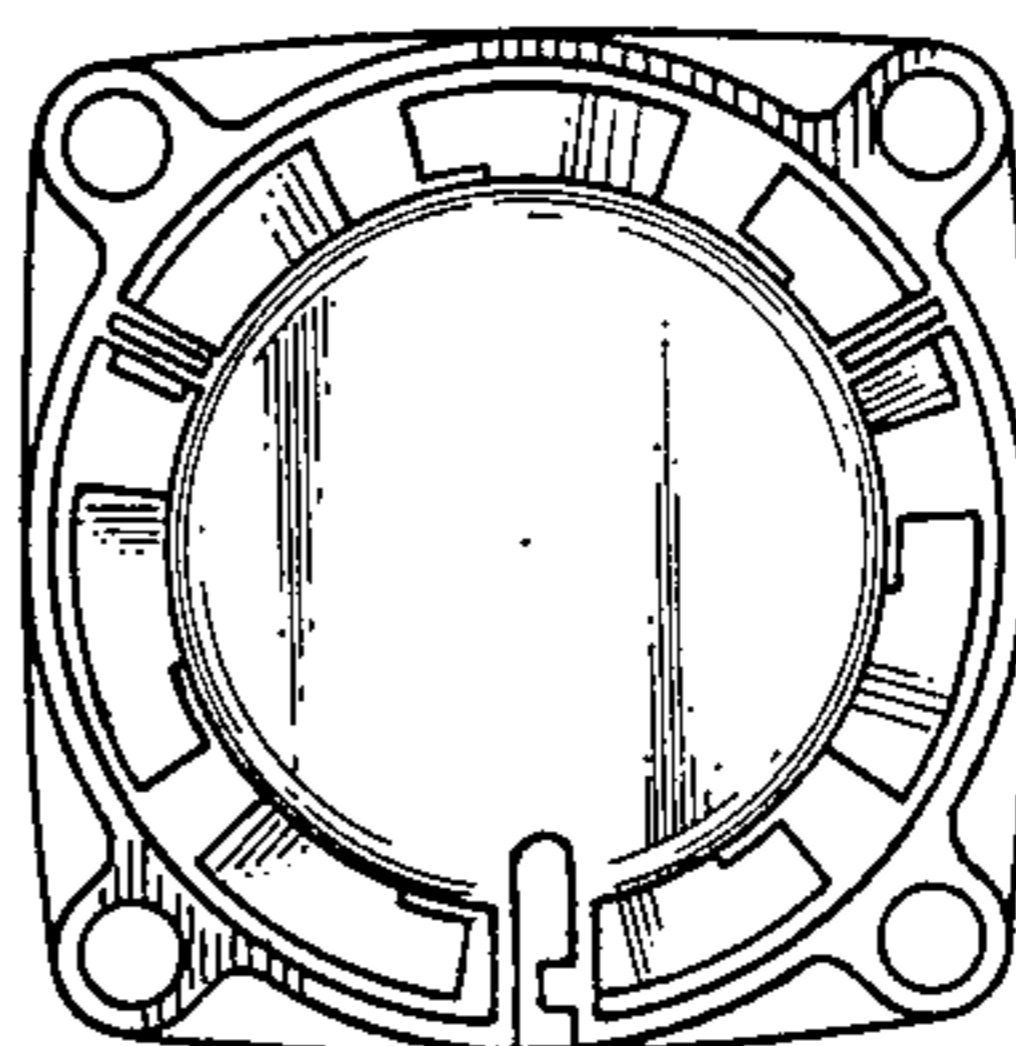

FIG. 28

