

[54] CASSETTE-PLAYER

- [75] Inventor: Murray I. C. Camens, Den Bosch, Netherlands
[73] Assignee: U.S. Philips Corp., New York, N.Y.
[**] Term: 14 Years
[21] Appl. No.: 926,265
[22] Filed: Nov. 3, 1986

[30] Foreign Application Priority Data

- May 14, 1986 [GB] United Kingdom 1034104
[52] U.S. Cl. D14/6; D14/2
[58] Field of Search D14/1, 2, 3, 5, 6, 68,
D14/70, 71, 72, 75, 99; 369/77.1, 77.2

[56] References Cited

U.S. PATENT DOCUMENTS

- D. 239,870 5/1976 Pinsler et al. D14/75
D. 283,122 3/1986 Sumita D14/70 X

OTHER PUBLICATIONS

Stereo Review, Apr. 1986, p. 48, top of page, Toshiba XR-P9, CD player.
HFD, 6/2/86, p. 64, CD player.
Radio Shack 1986 catalog, p. 40-bottom right, mini-cassette recorder.

Primary Examiner—Bernard Ansher
Assistant Examiner—Theodore M. Shooman
Attorney, Agent, or Firm—Robert T. Mayer

[57] CLAIM

The ornamental design for a cassette-player, as shown.

DESCRIPTION

FIG. 1 is a front, top and left side perspective view of a cassette-player showing my new design;
FIG. 2 is a rear elevational view thereof;
FIG. 3 is a front elevational view thereof;
FIG. 4 is a right side elevational view thereof;
FIG. 5 is a left side elevational view thereof;
FIG. 6 is a top plan view thereof; and
FIG. 7 is a bottom plan view thereof.

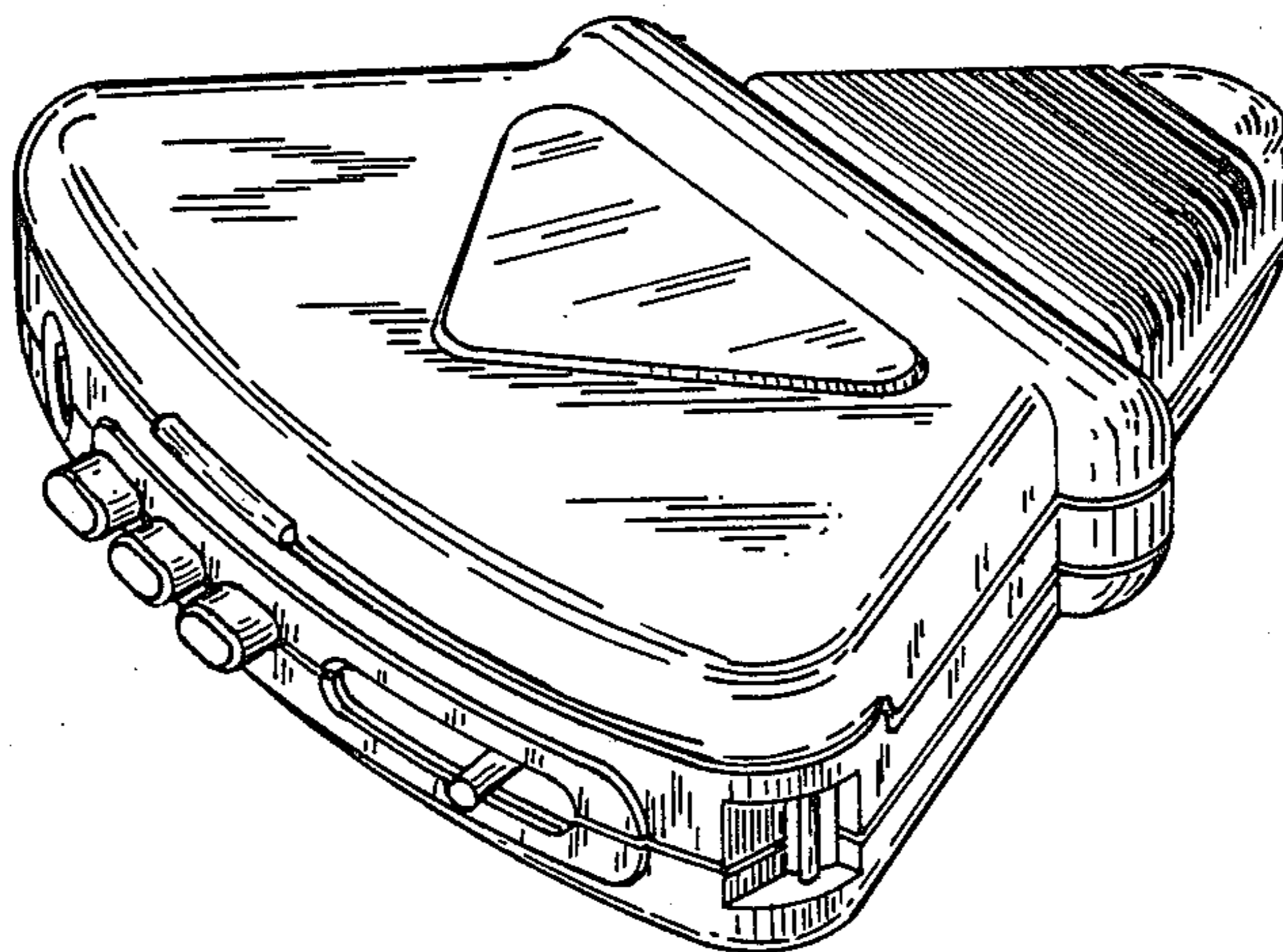

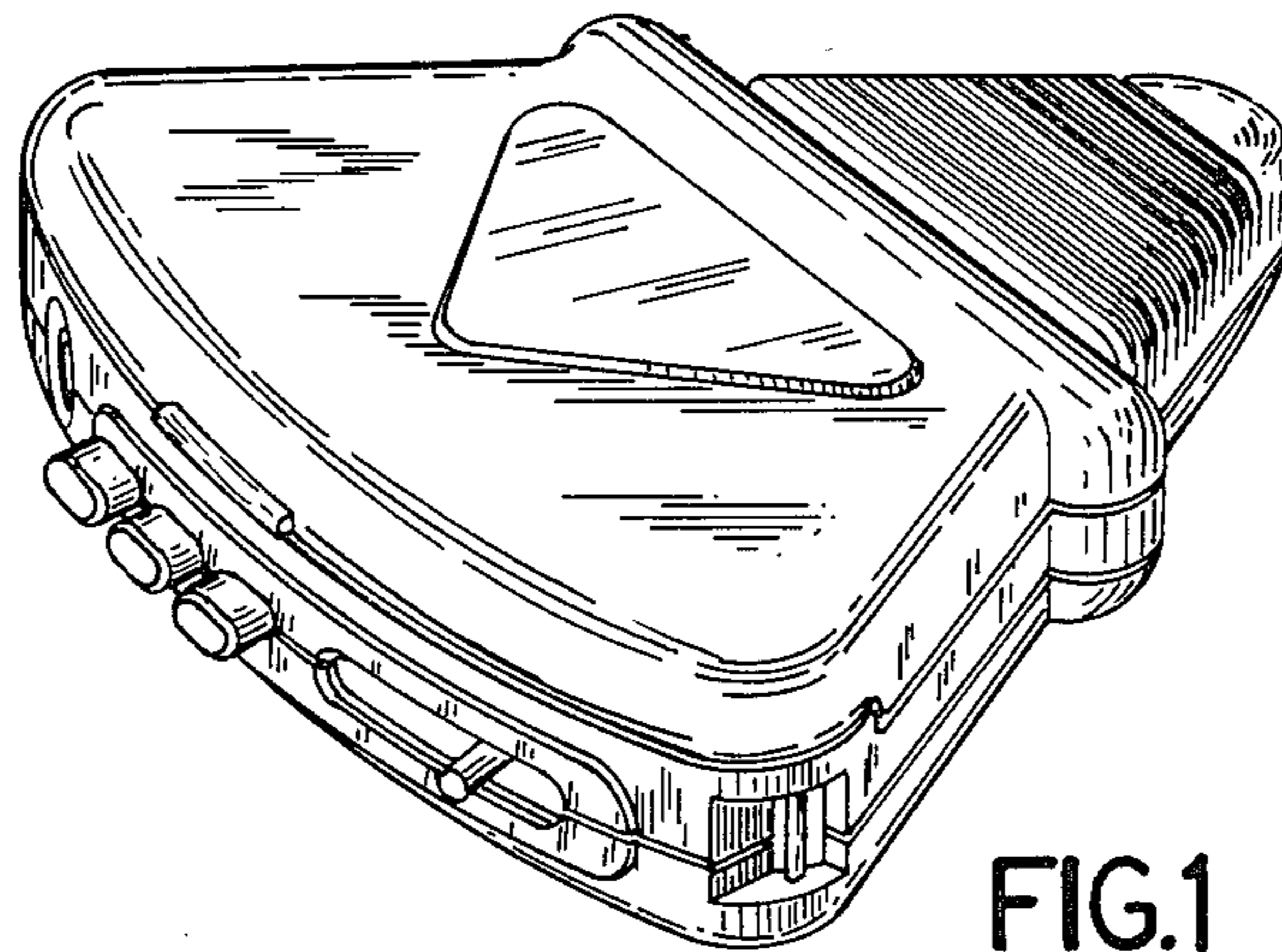

FIG.1

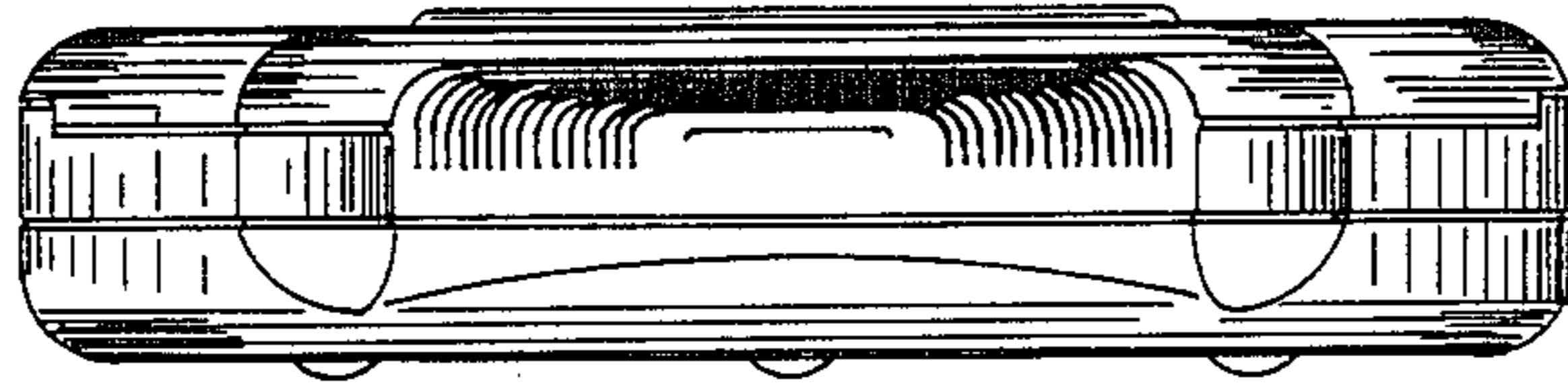

FIG. 2

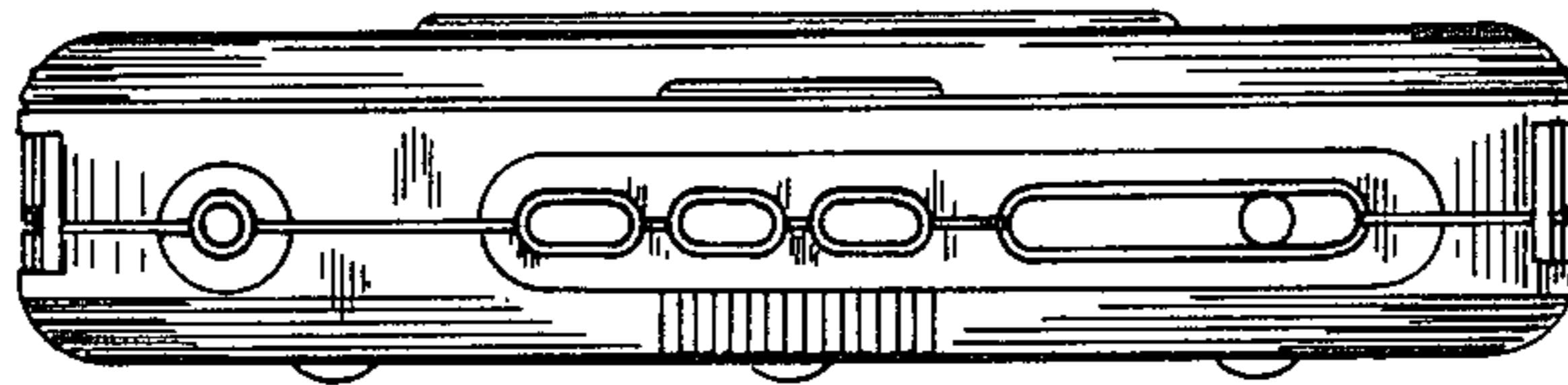

FIG. 3

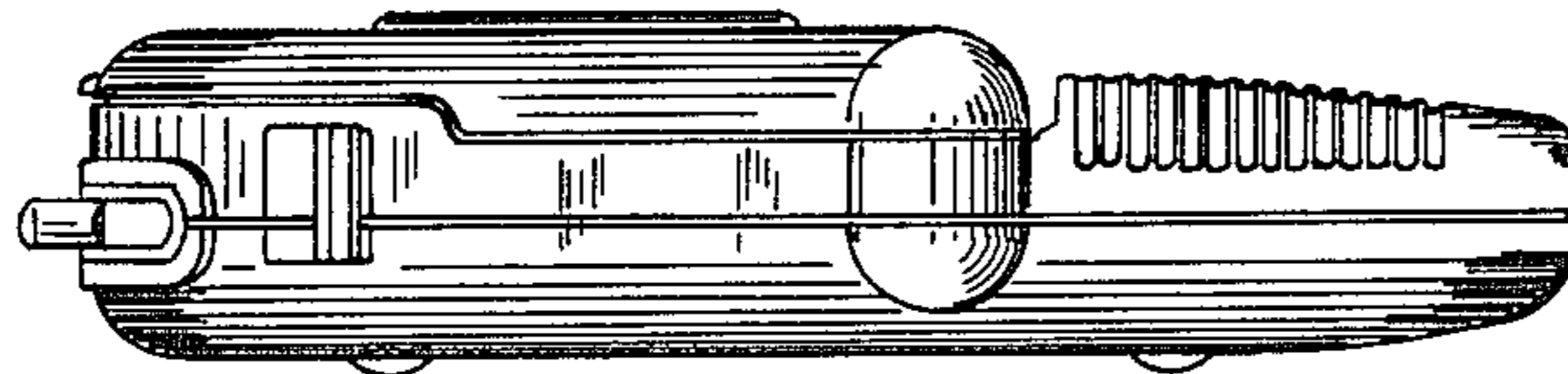

FIG. 4

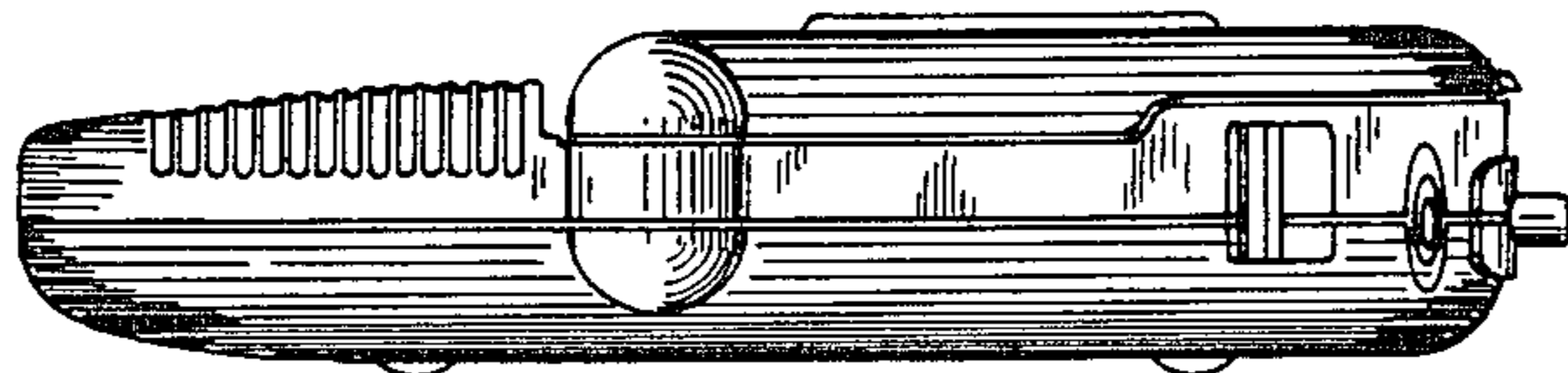

FIG. 5

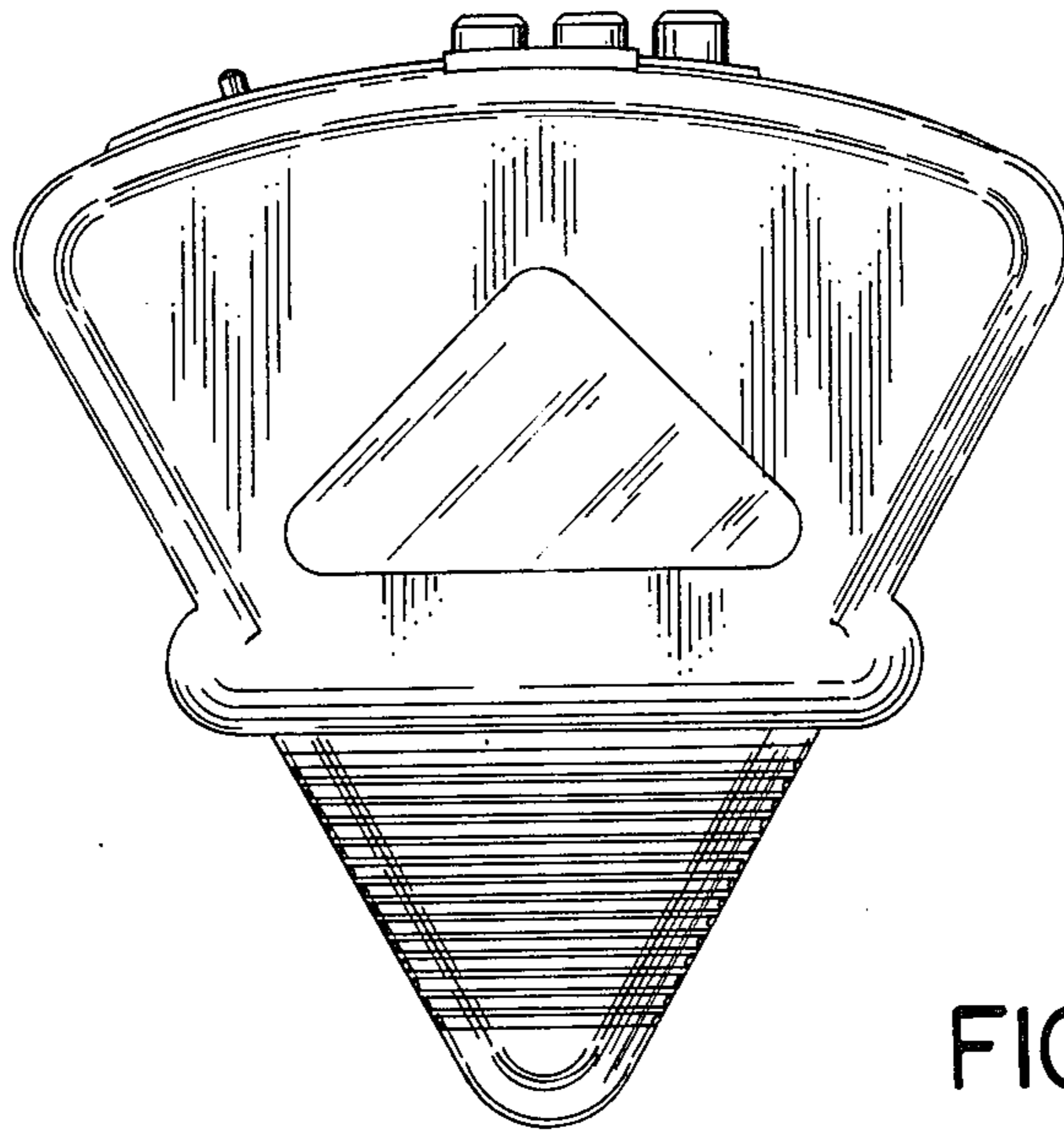

FIG. 6

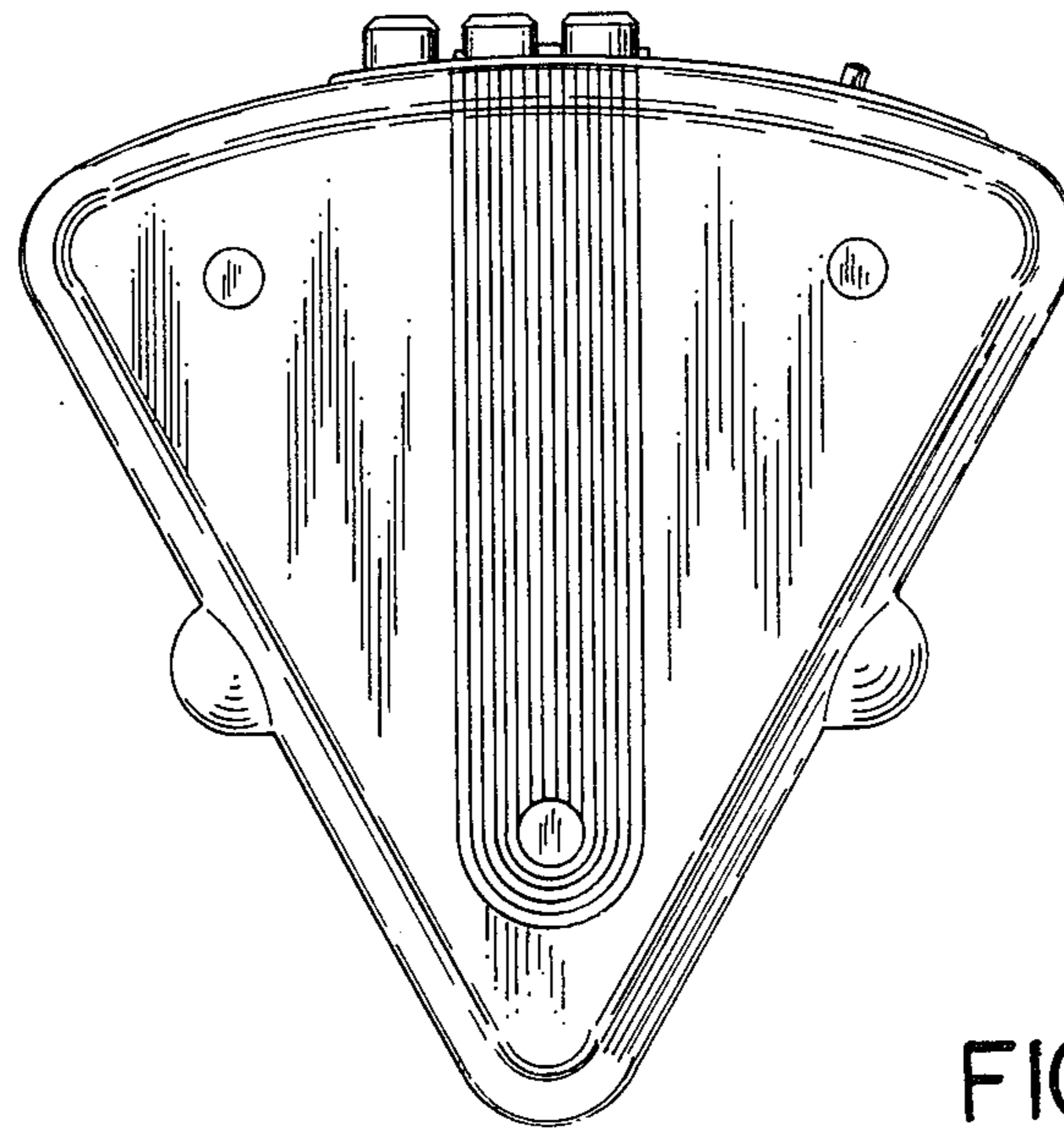

FIG. 7