

[54] CLOCK

D. 283,403 4/1986 Chan D10/15

[75] Inventors: James M. Rittenhouse, Watchung, N.J.; Barry M. Haber, Westport, Conn.; Ting W. Wong, Oceanport, N.J.

OTHER PUBLICATIONS

Hong Kong Trader-6/79-p. 129-clock at bottom right.

Primary Examiner-Nelson C. Holtje
Attorney, Agent, or Firm-Haynes N. Johnson

[73] Assignee: Conair Corporation, Edison, N.J.

[57] CLAIM

[**] Term: 14 Years

The ornamental design for a clock, as shown and described.

[21] Appl. No.: 834,848

DESCRIPTION

[22] Filed: Feb. 21, 1986

[52] U.S. Cl. D10/15; D10/18

[58] Field of Search D10/1-29,
D10/15; 368/239-242, 276-277, 280-282, 285

FIG. 1 is a front elevational view of a clock, showing our new design;
FIG. 2 is a right side elevational view thereof;
FIG. 3 is a right side elevational view thereof, with the support stand extended;
FIG. 4 is a left side elevational view thereof;
FIG. 5 is a rear elevational view thereof;
FIG. 6 is a top plan view thereof;
FIG. 7 is a bottom plan view thereof.

[56] References Cited

U.S. PATENT DOCUMENTS

- D. 255,551 6/1980 Hirota D10/15
- D. 269,857 7/1983 Goodin D10/15
- D. 279,551 7/1985 Claytor D10/2

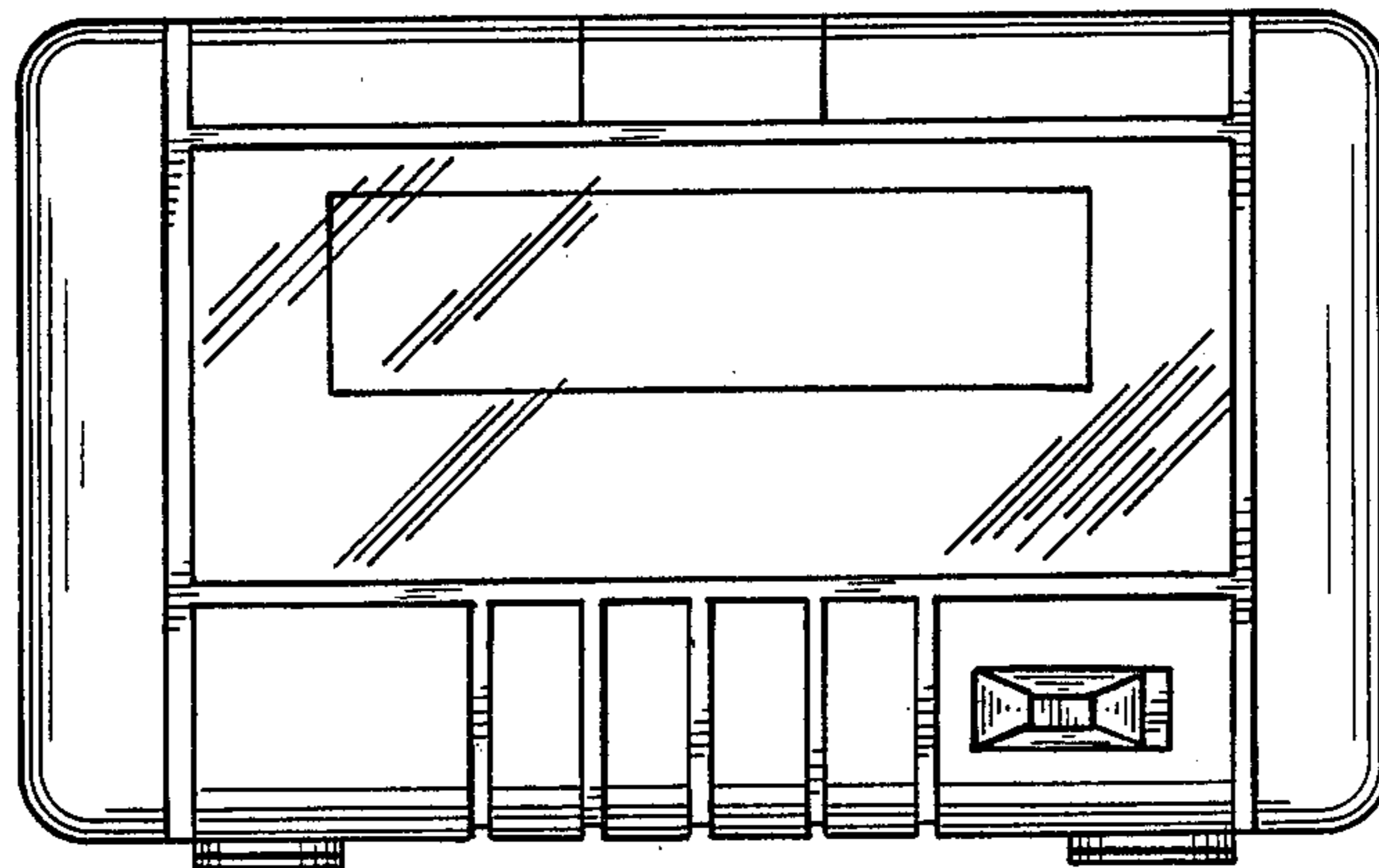

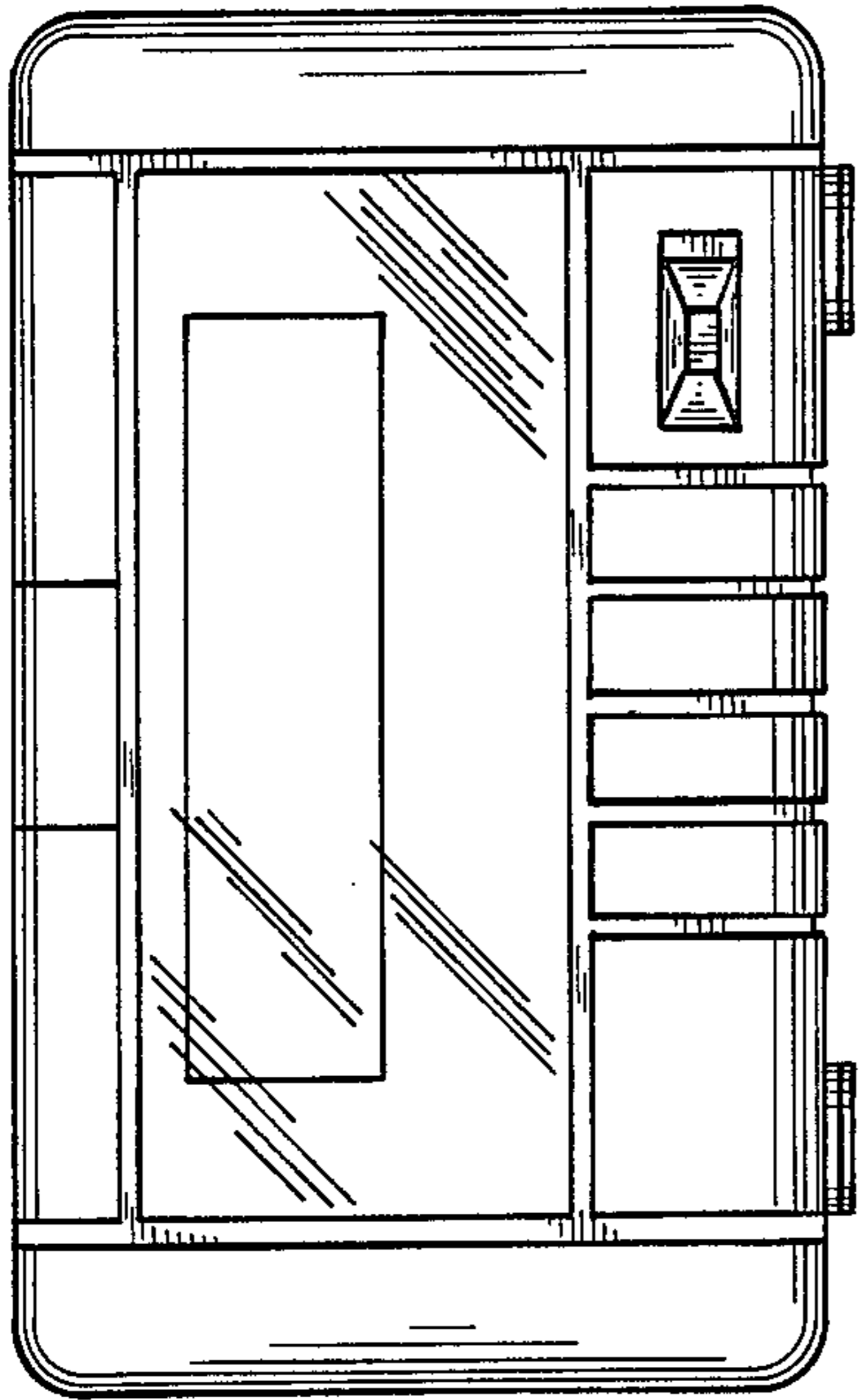

FIG. 1

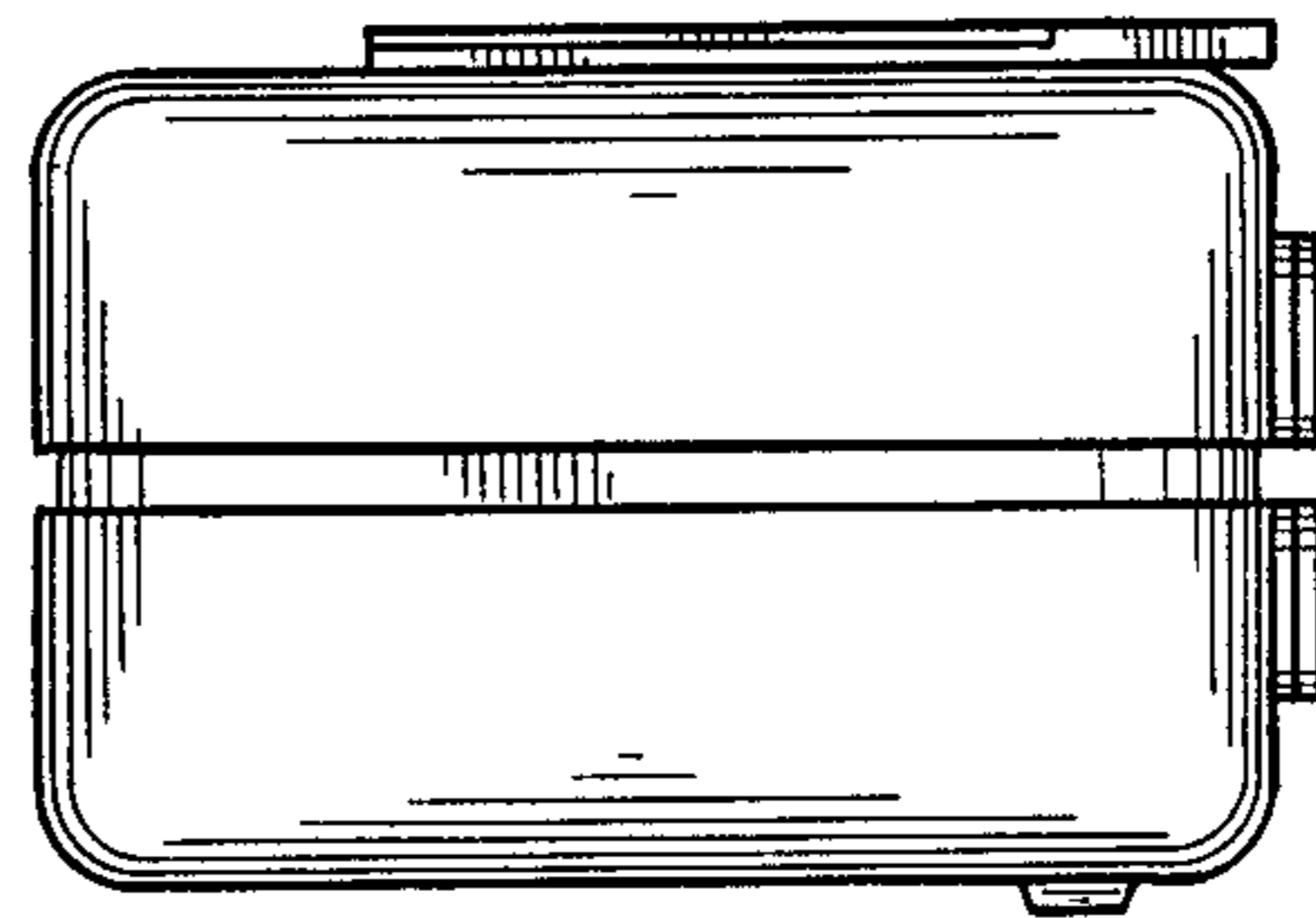

FIG. 2

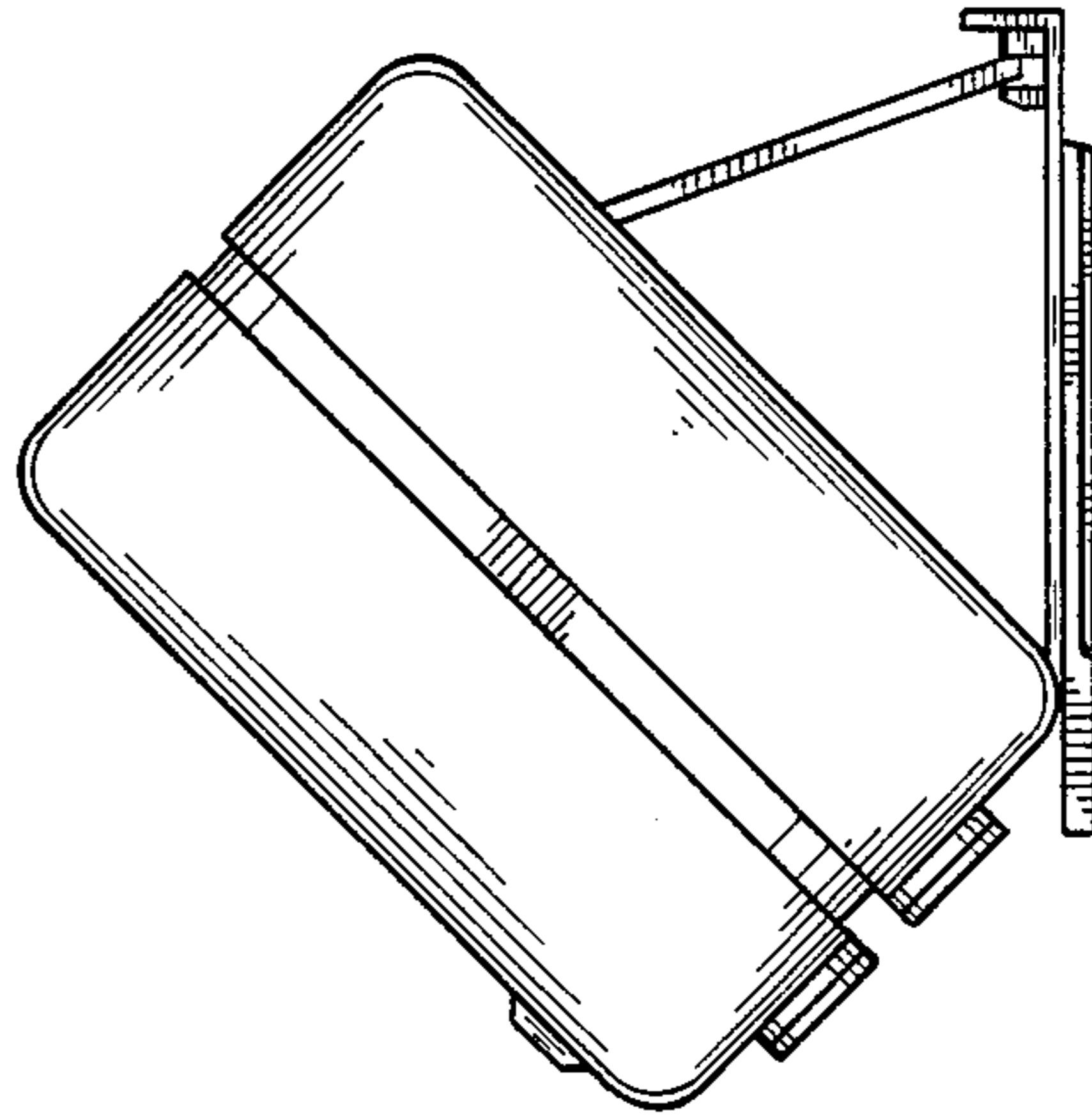

FIG. 3

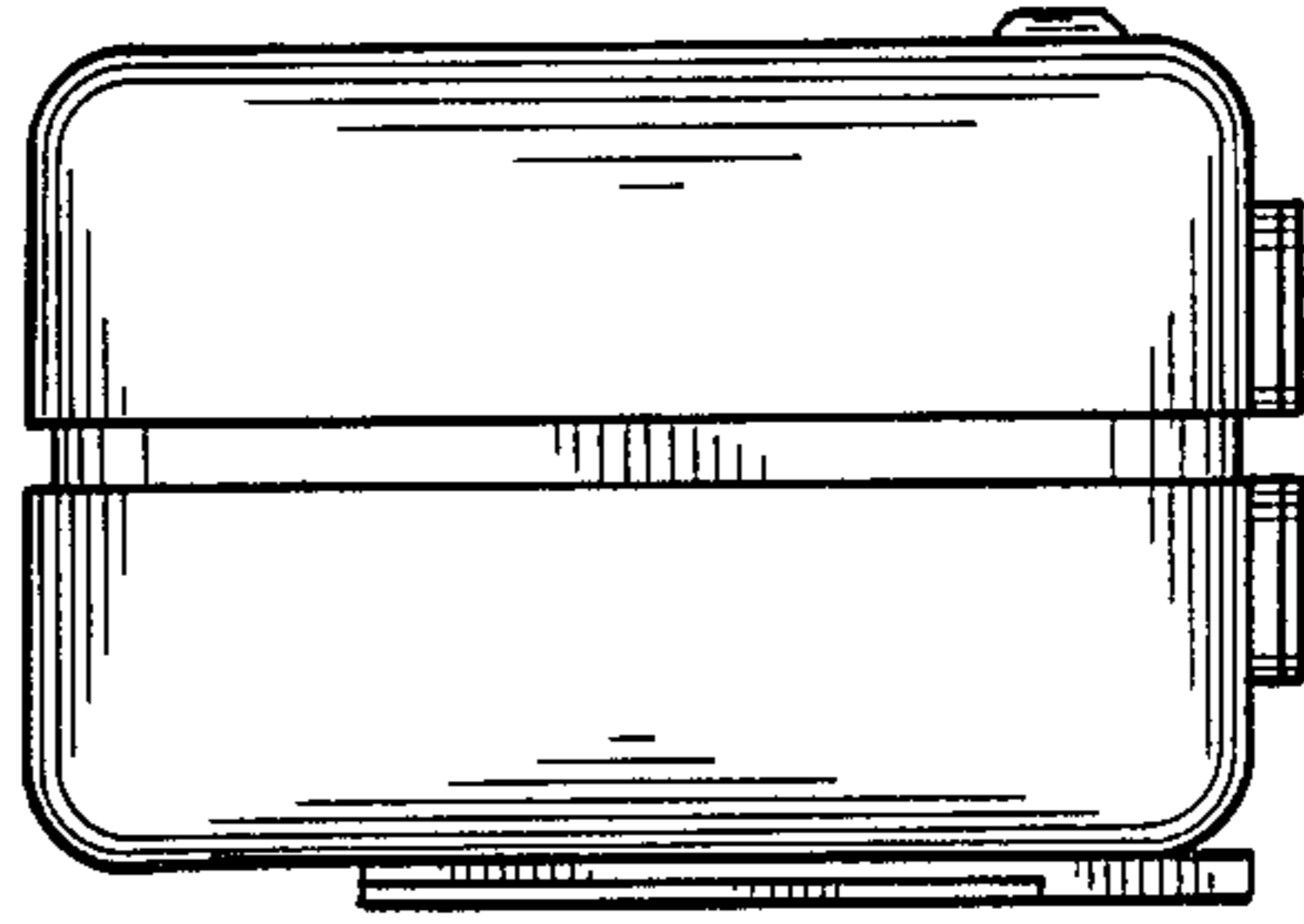

FIG. 4

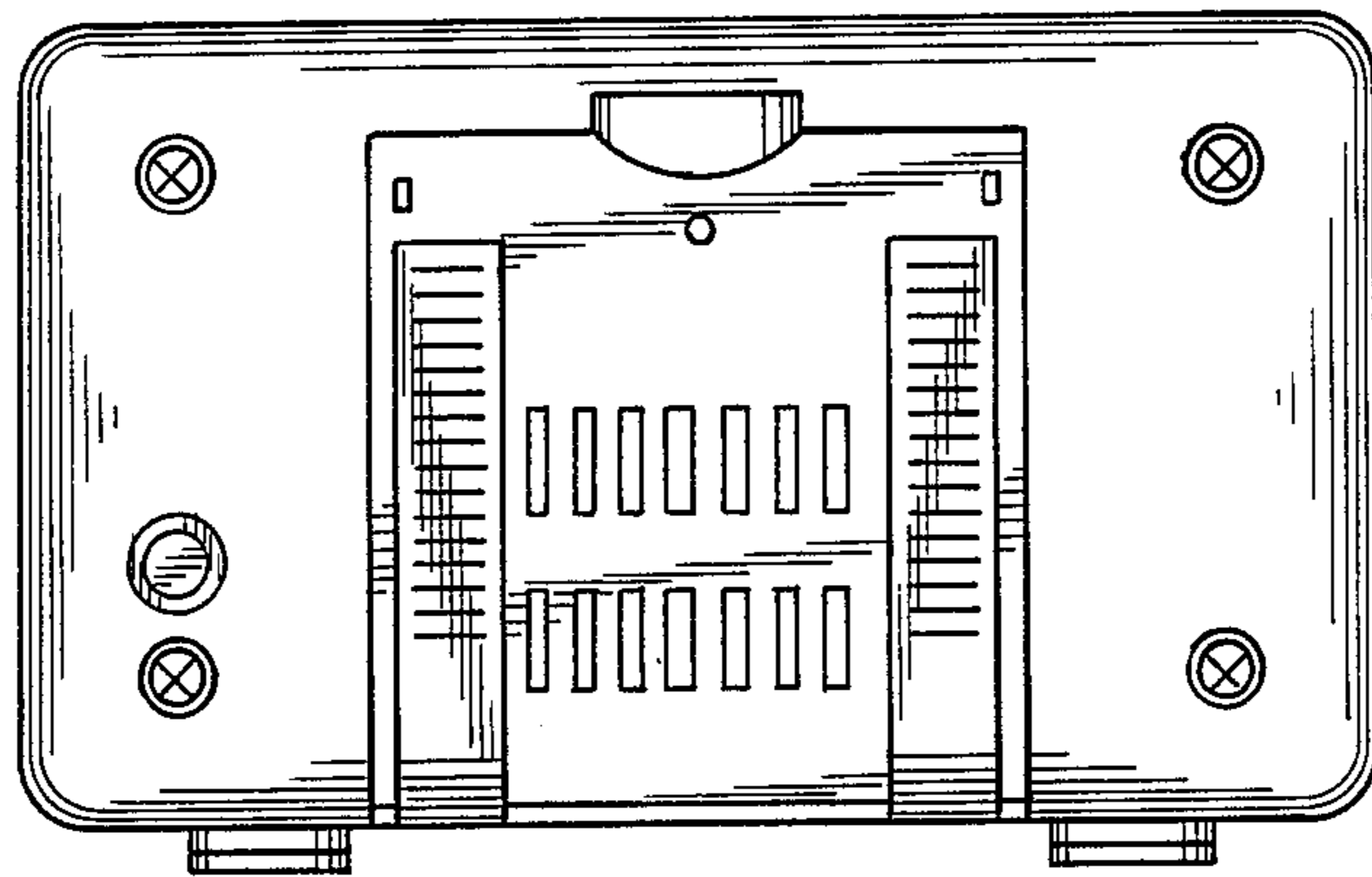

FIG. 5

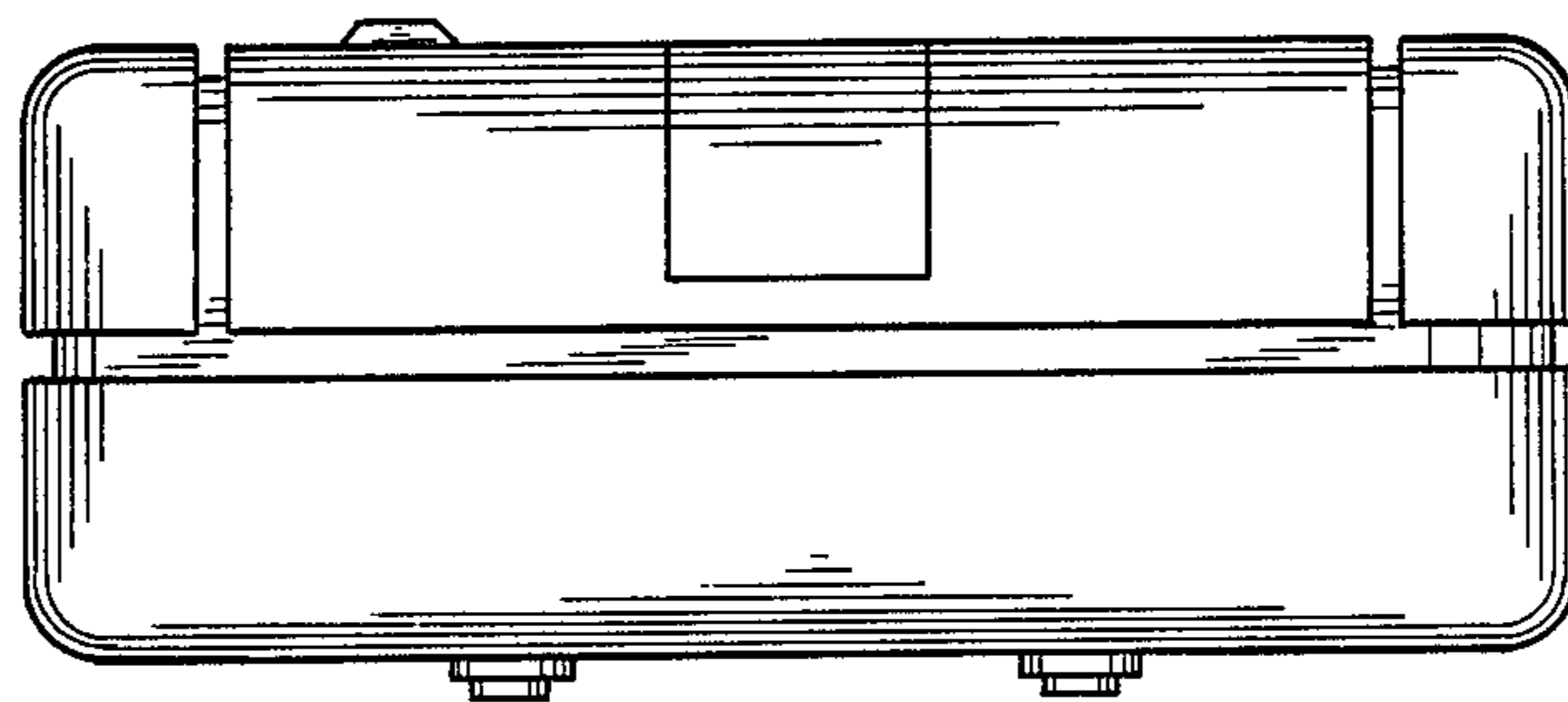

FIG. 6

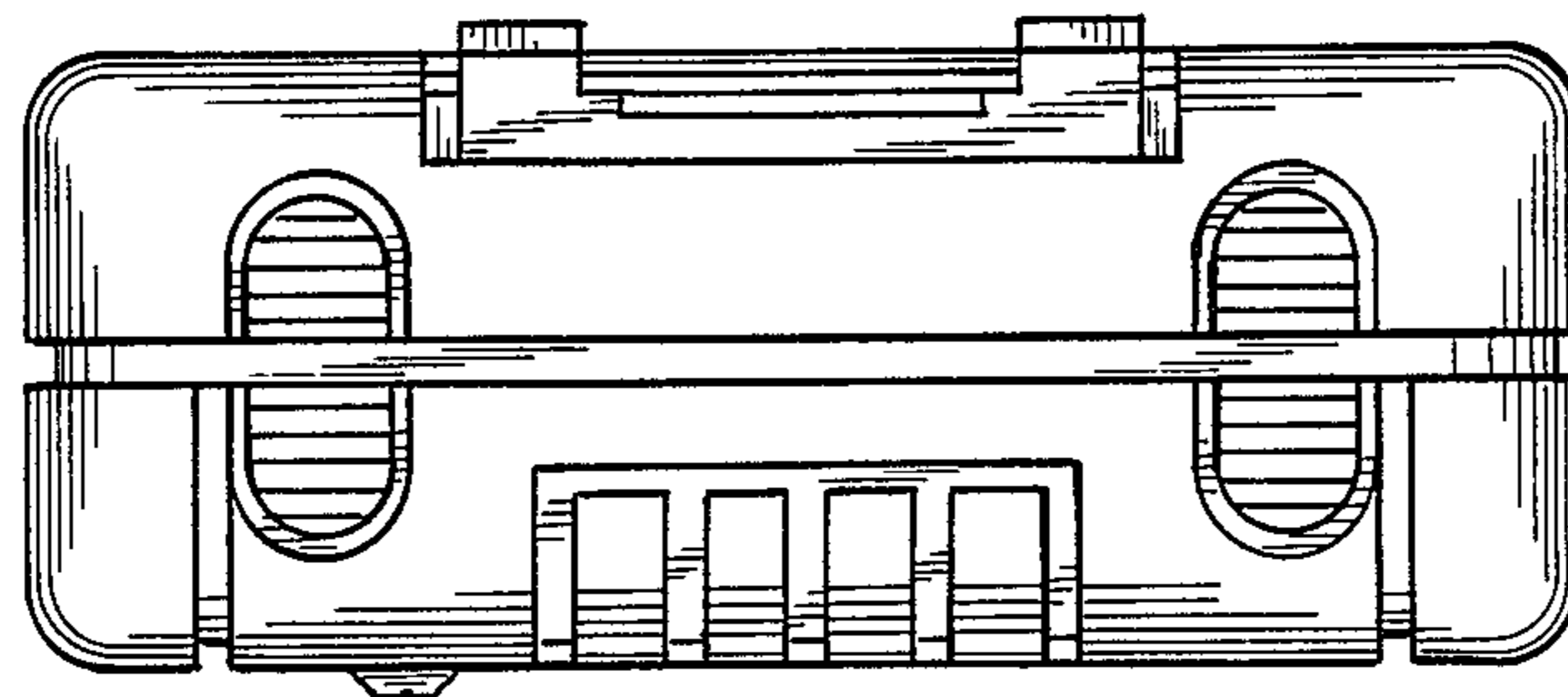

FIG. 7