

[54] BABY ROCKER

[75] Inventor: Michael C. Wilson, Glen Ellyn, Ill.

[73] Assignee: The Tyke Corporation, Chicago, Ill.

[\*\*] Term: 14 Years

[21] Appl. No.: 786,873

[22] Filed: Oct. 11, 1985

[52] U.S. Cl. .... D6/348; D6/333

[58] Field of Search ..... D6/333, 344, 345, 346, D6/347, 348; 297/184, 258, 260, 377

[56] References Cited

U.S. PATENT DOCUMENTS

D. 246,682	12/1977	Nakao	.....	D6/338
D. 288,757	3/1987	Hoeckel	.....	D6/333 X
D. 289,473	4/1987	Myers	.....	D6/333 X
4,293,162	10/1981	Pap et al.	.....	297/184

4,583,779 4/1986 Myers ..... 297/184

Primary Examiner—Bruce W. Dunkins  
Attorney, Agent, or Firm—Cook, Wetzel & Egan, Ltd.

[57] CLAIM

The ornamental design for a baby rocker, substantially as shown and described.

DESCRIPTION

FIG. 1 is a front perspective view of a baby rocker showing my design; FIG. 2 is a left side elevation view of the rocker; FIG. 3 is a right side elevation view of the rocker; FIG. 4 is a front elevation view of the rocker; FIG. 5 is a top plan view of the rocker; FIG. 6 is a bottom plan view of the rocker; FIG. 7 is a rear elevation view of the rocker; and FIG. 8 is a right front perspective view of the rocker, without the sun hood and with the rocker stops in an alternative position.

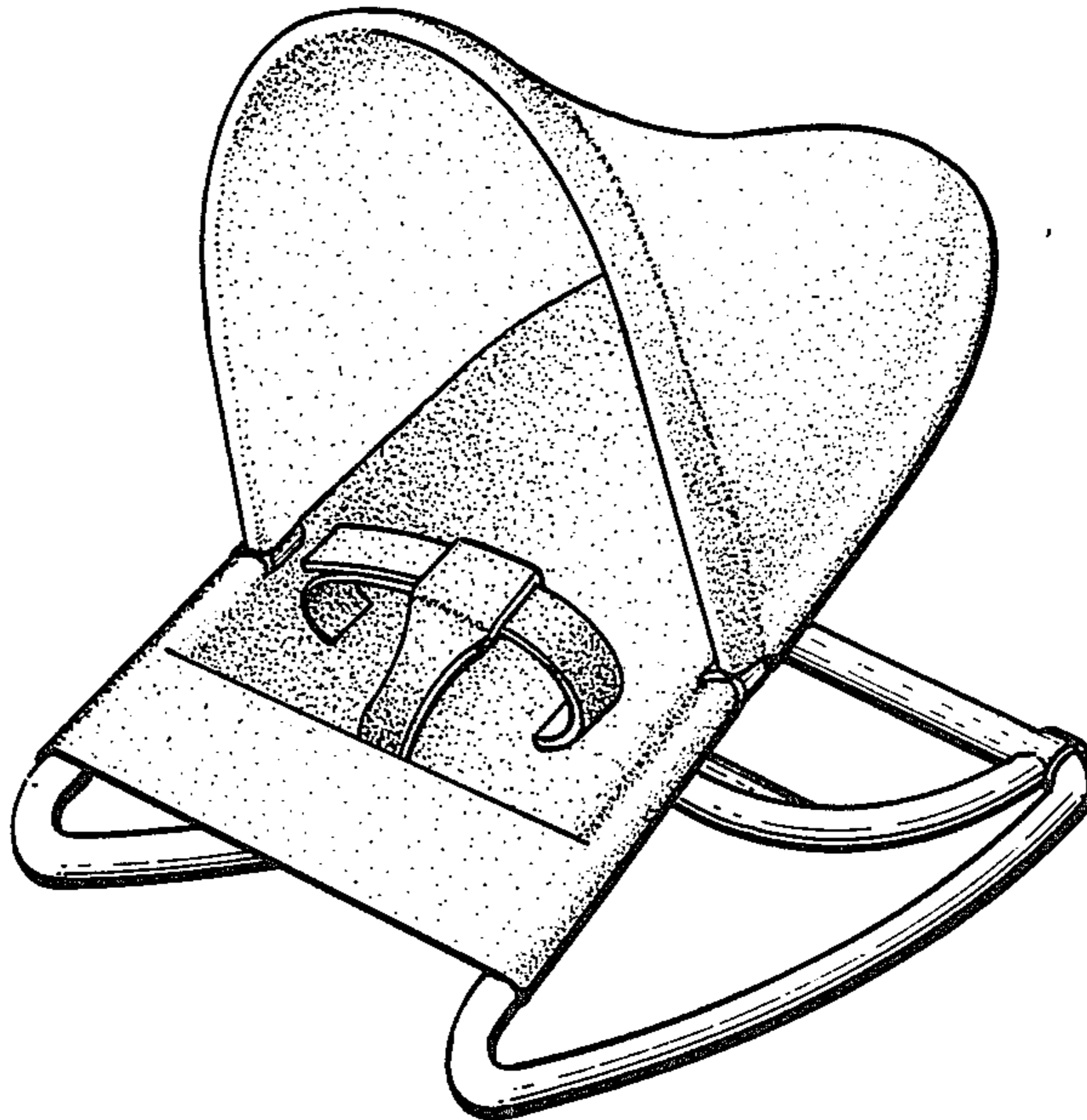

FIG. 1

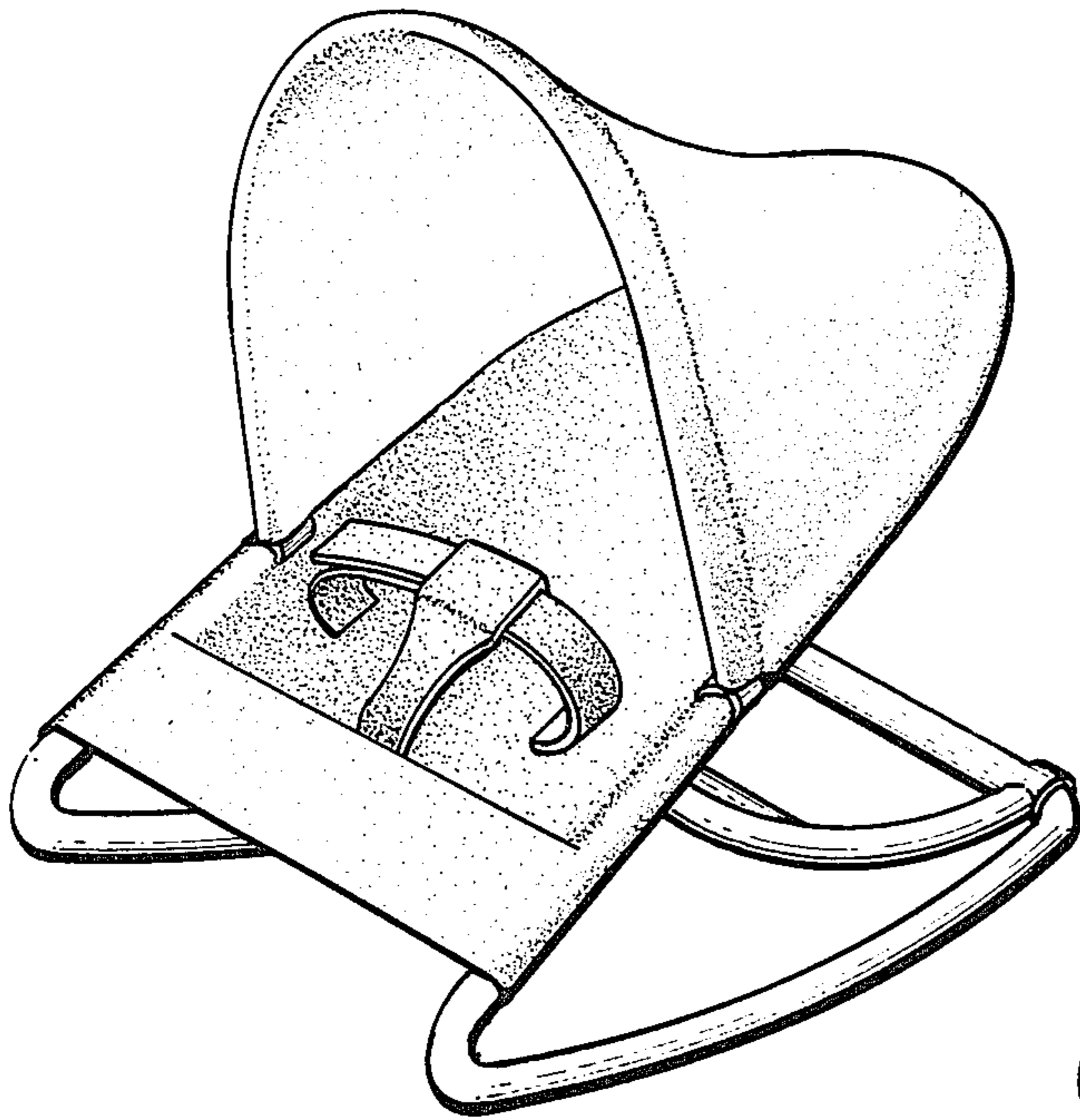

FIG. 2

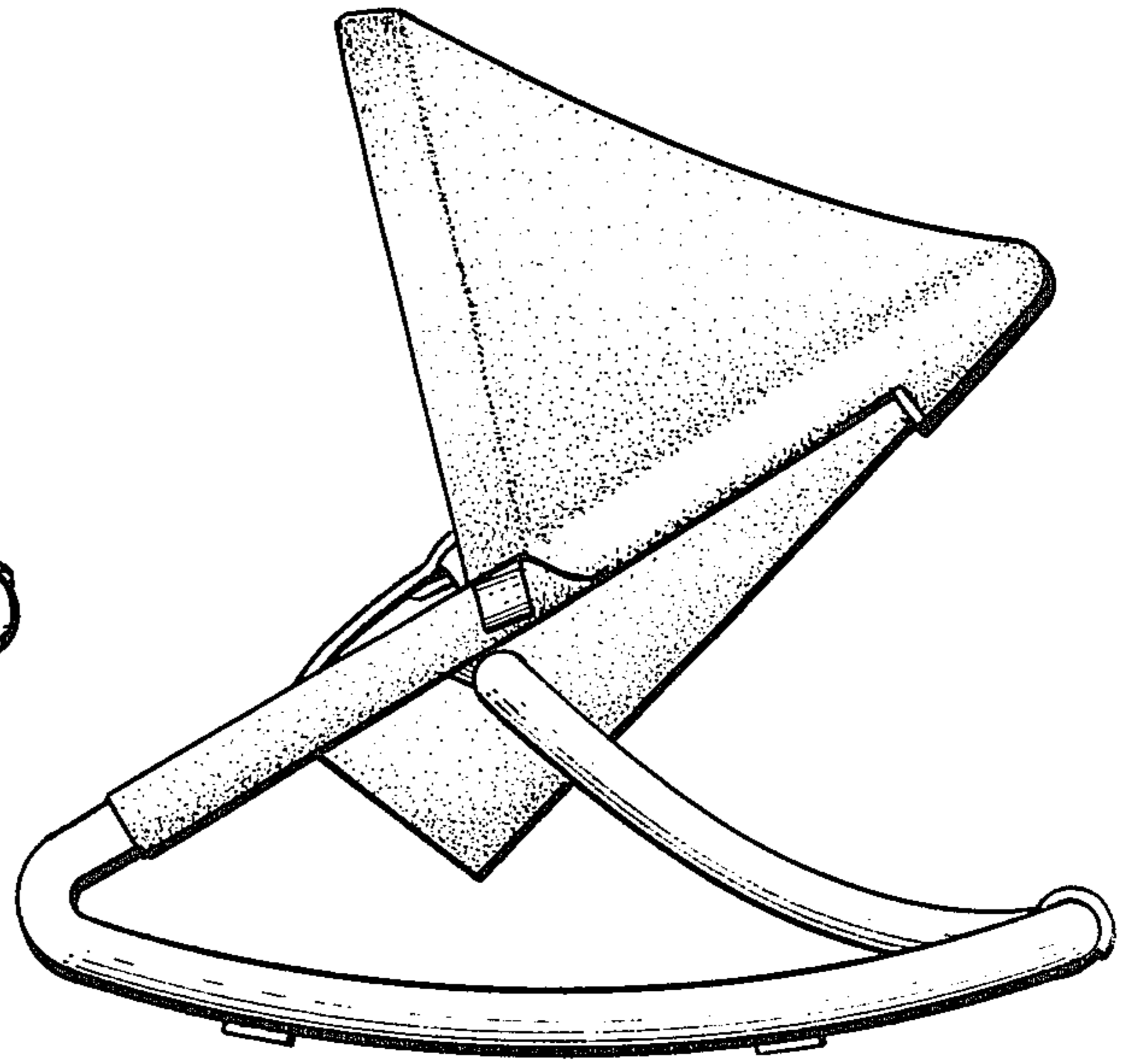

FIG. 3

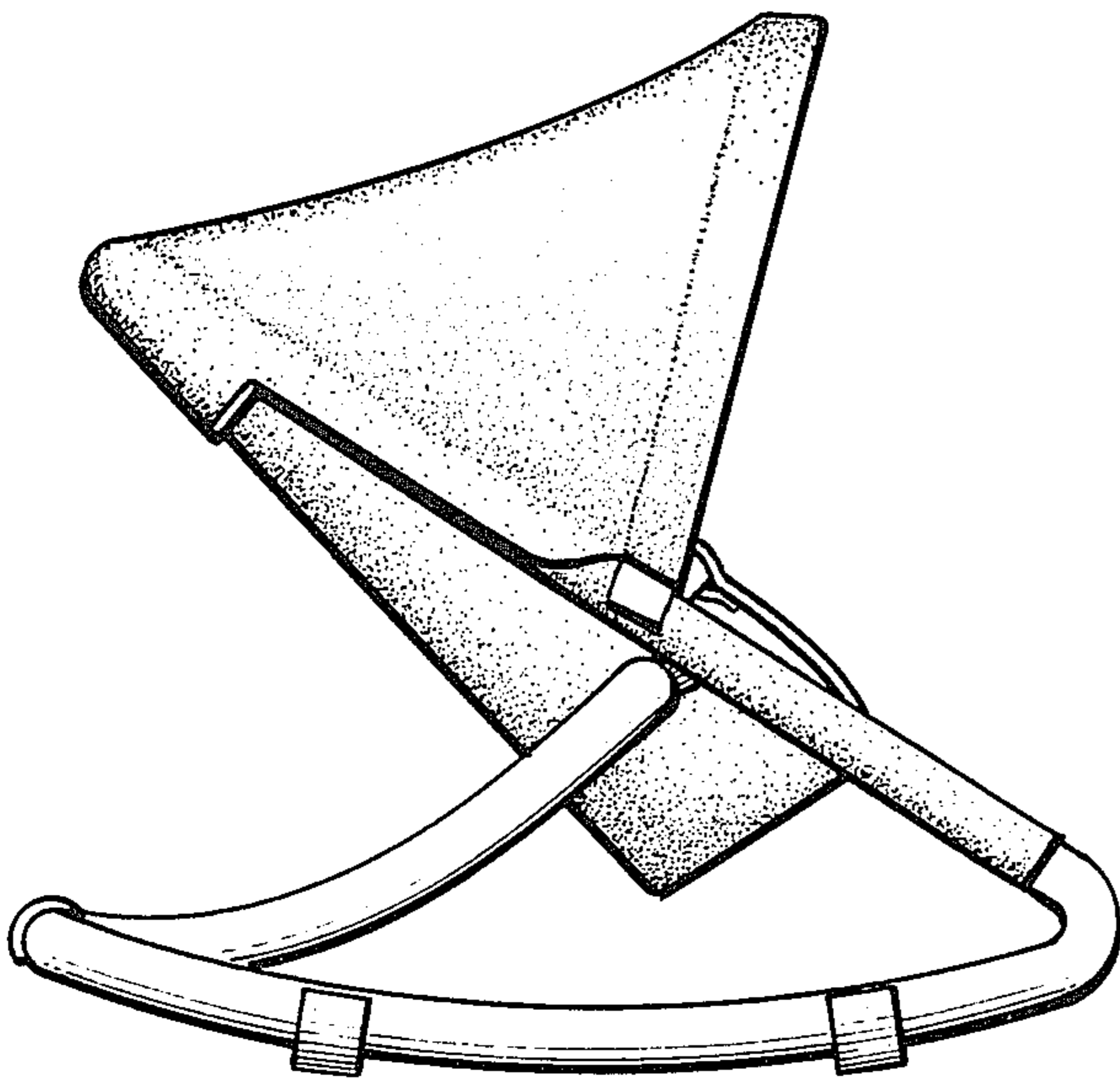
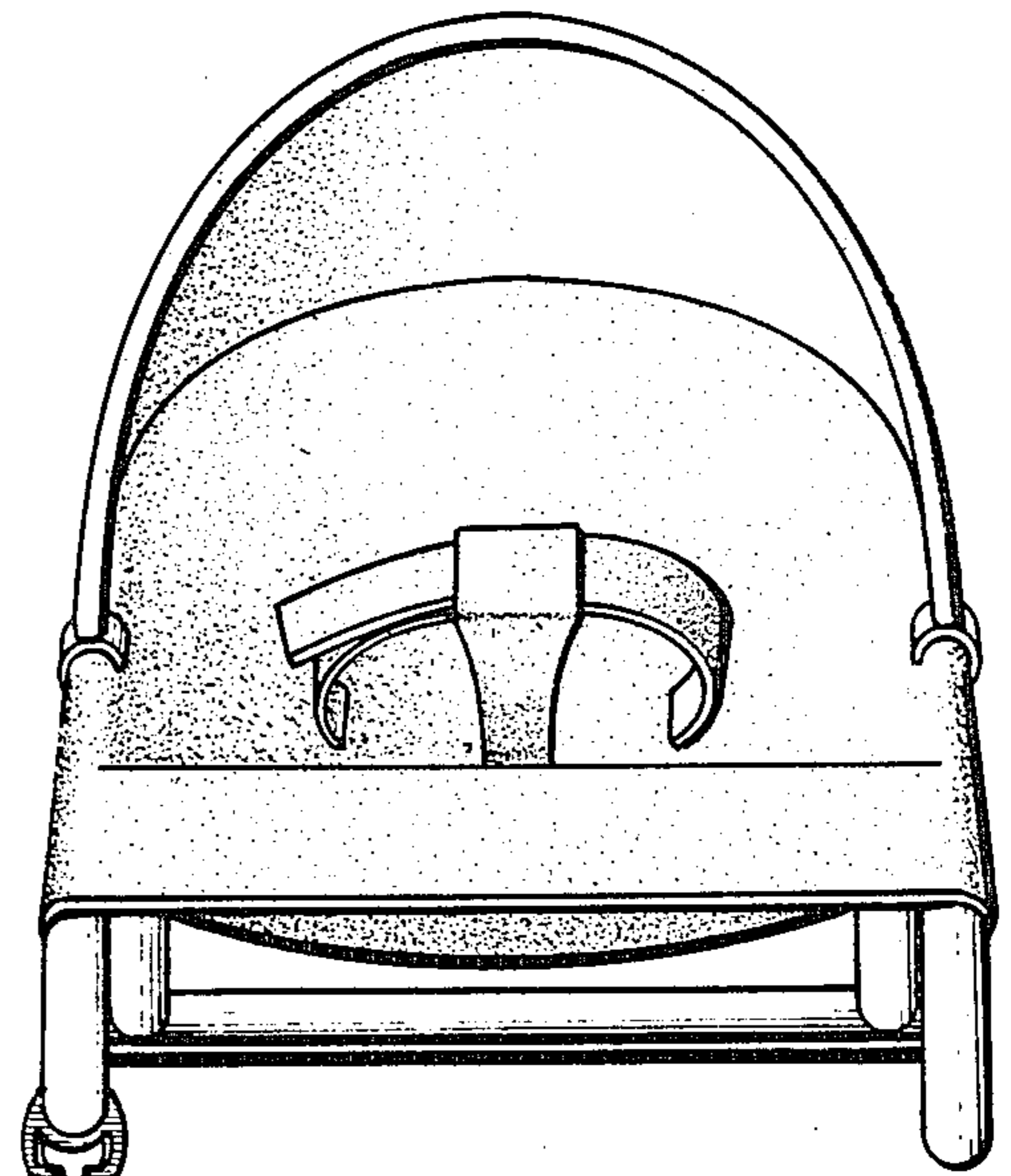

FIG. 4



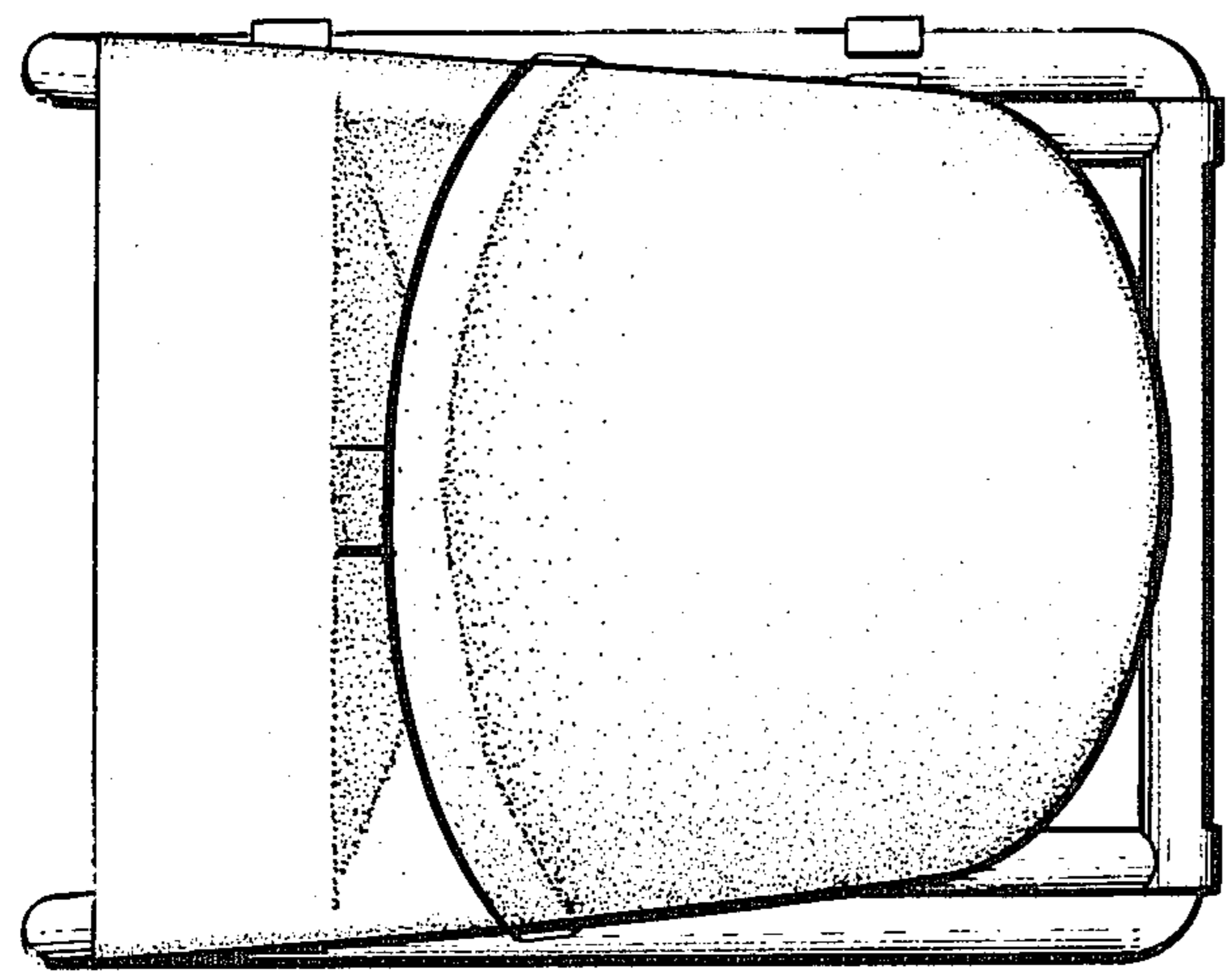

FIG. 5

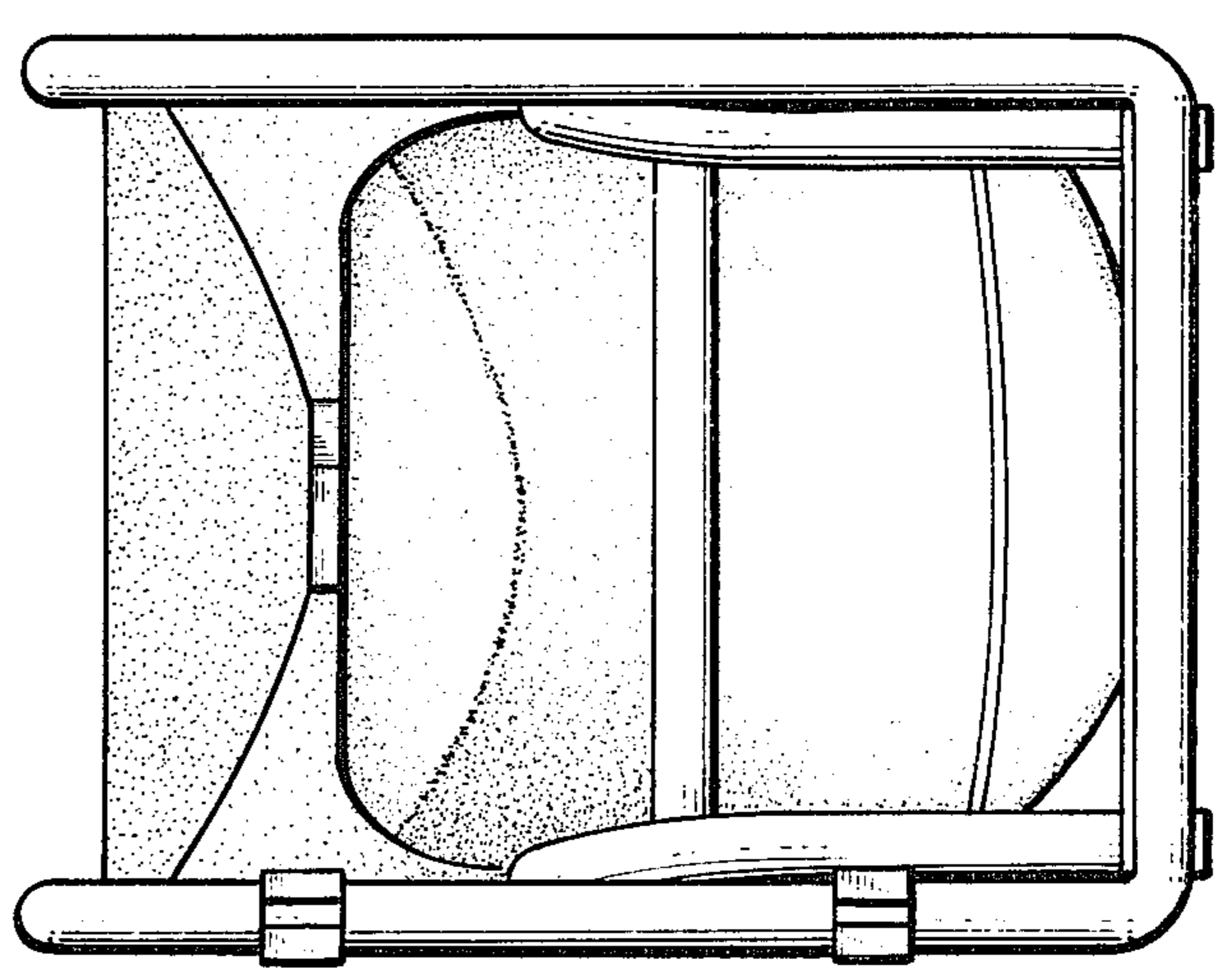

FIG. 6

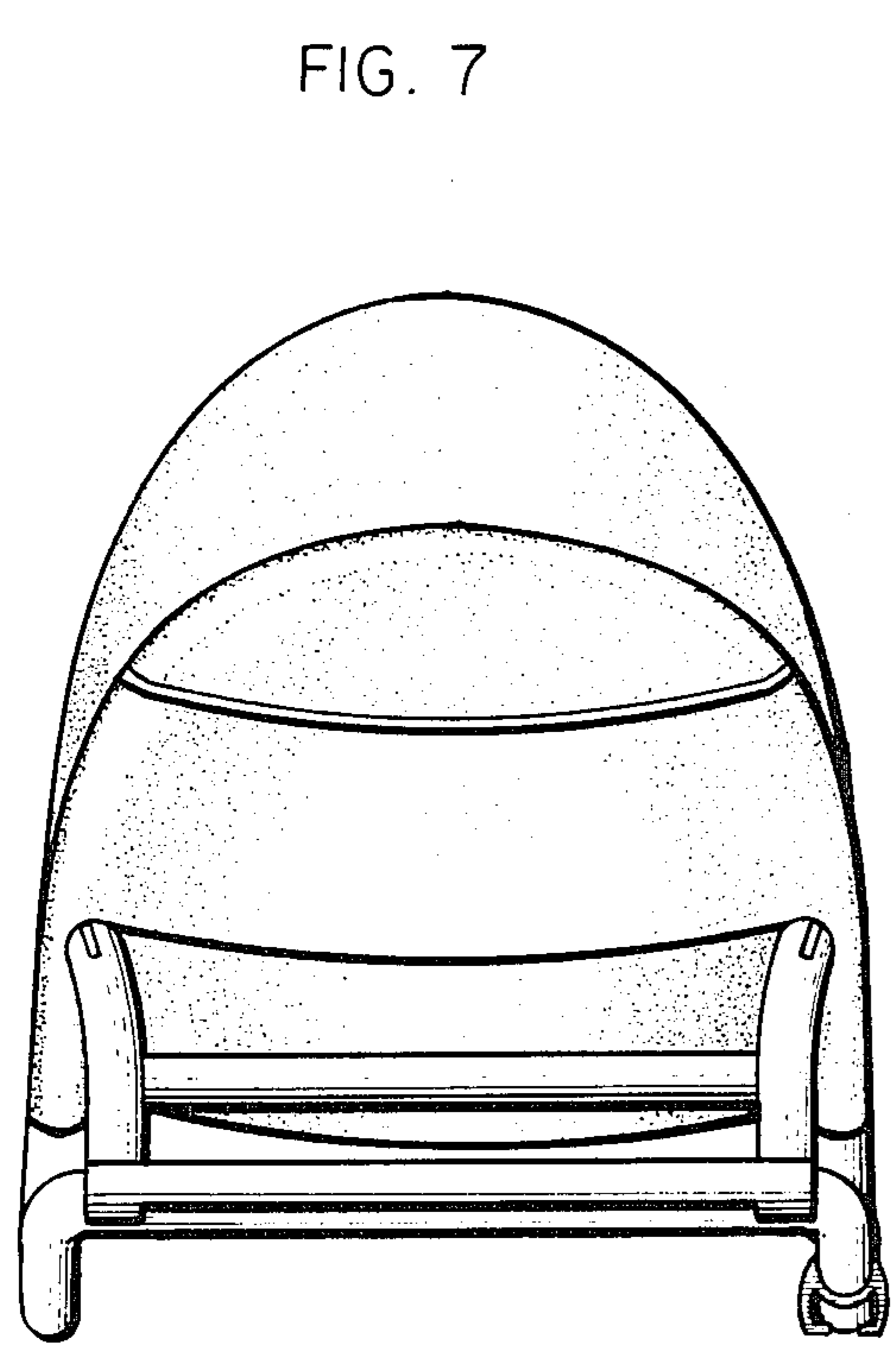

FIG. 7

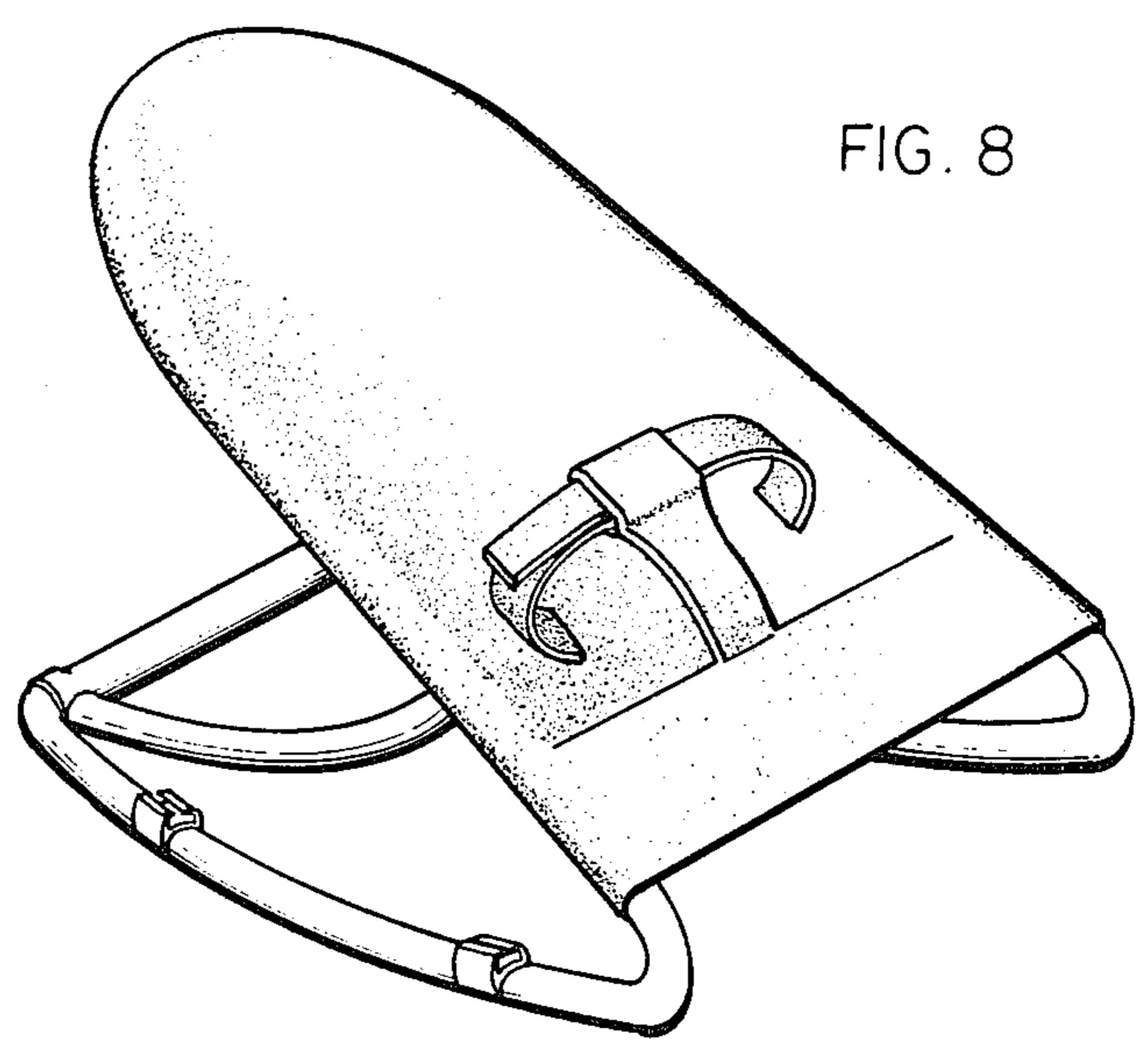

FIG. 8